

Industrial Hoses

Industrie Schläuche

Tubi Industriali

Tuyaux Industriels



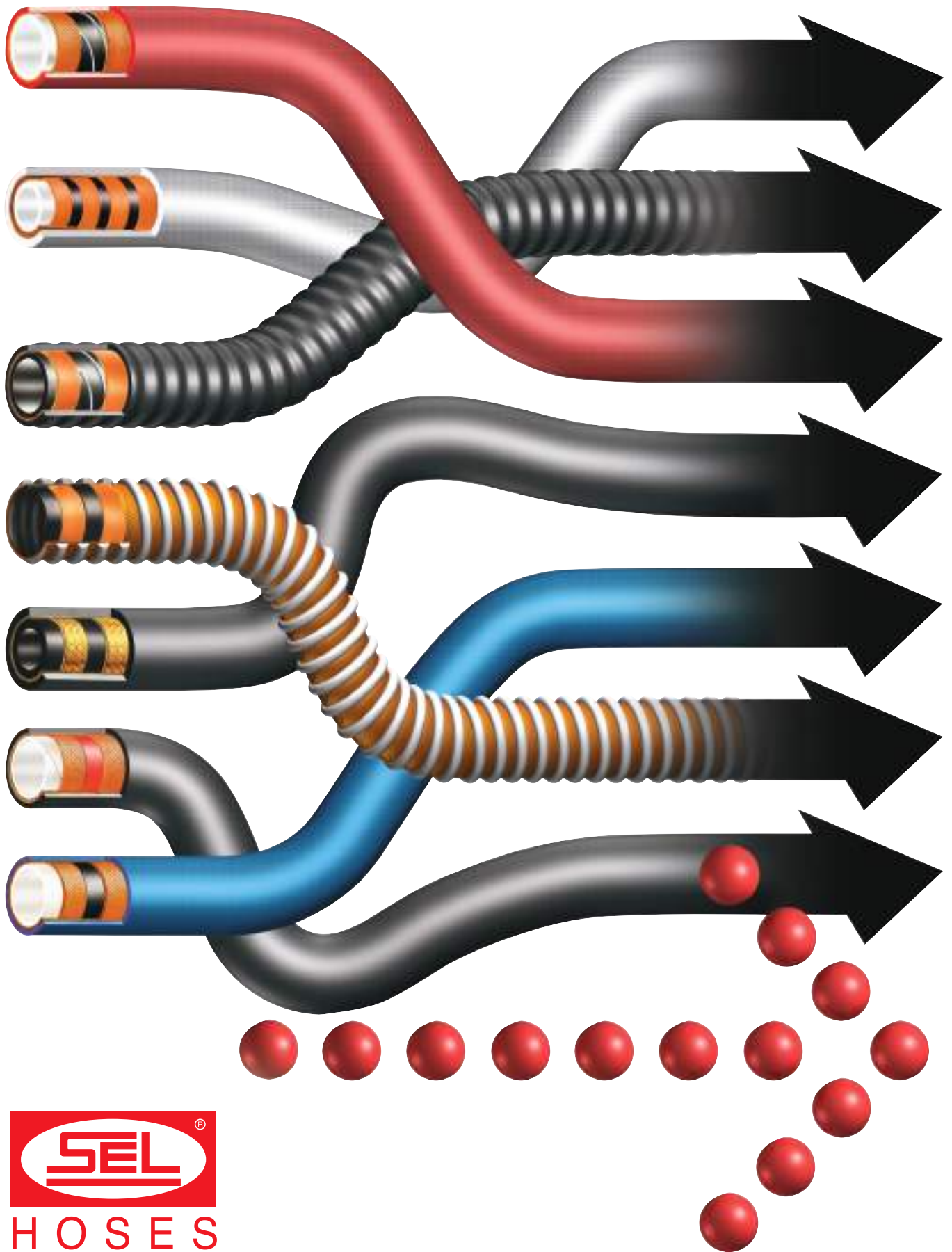

H O S E S

An Eaton Brand

2 0 1 3

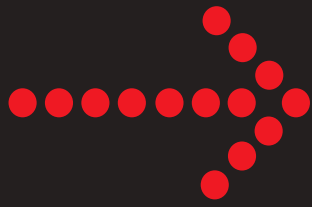

Our Production Facilities



Research & Development - Quality



- ★ Polimer Kauçuk Engineering Department is conducted R&D activities for material development and component design, testing and in-house verification facilities.
- ★ Extremely skilled and experienced engineers are focused on research and development projects
- ★ Polimer Kauçuk Engineering Laboratory performs as a test laboratory and accredited according to EN ISO/IEC 17025:2005



QUALITY SYSTEM AND CERTIFICATION



SYSTEM CERTIFICATIONS

DS - EN ISO 9001:2008

DS - EN ISO 14001:2004

DS - OHSAS 18001:2008

DEKRA - ISO/TS 16949:2002

TÜRKAK - TS EN ISO/IEC 17025:2005



PRODUCT CERTIFICATIONS

TSE

LLOYD'S REGISTER



AMECA (Automotive Manufacturers Equipment Compliance Agency, Inc.)

MSHA (Mine Safety and Health Administration)



ABS (American Bureau of Shipping)

GOST-R

LUXCONTROL



UL

RST

TÜV



CERISIE

KIWA



I N D E X

Code	Product Name	Application	Page
------	--------------	-------------	------

Water • Wasser • Acqua • Eau



LL/W111	LONG-SU	Water	16
WLP110	EGE-6	Low Pressure Water	17
WMP111	EGE-10	Medium Pressure Water	18
WLF131	FLAT	Layflat Water	19
WLF136 -138	FLAT	High Pressure Layflat Water	20
WSD141	KARADENİZ-10	Water Suction & Discharge	21
WSD142	KARADENİZ-16	Heavy Duty Water Suction & Discharge	22
WCSD120	AKDENİZ	Water Suction & Discharge - CORRUGATED	23
WSDFC125	ADRIATIC	Water Suction & Discharge - FLAT CORRUGATED	24
WSDR126	VAN	Water Suction & Discharge - CHanneled	25
TCH115	TERKOS	Tank Cleaning Hose	26
WAS 116	KARS	Artificial Snow	27

Sewer & Road Cleaning • Kanal- und Straßenreinigung • Lavaggio Fognatura & Strada • Hydrocourage & Route



SEW22K/200	TB KUKA - 200	Sewer Jetting - 200 BAR	30
TPSW165	TPU KUKA - 200	Sewer Jetting - 200 BAR	31
SEW22K/250	TB KUKA - 250	Sewer Jetting - 250 BAR	32
TPSW166	TPU KUKA - 250	Sewer Jetting - 250 BAR	33
SEW31K/250	SWB KUKA - 250	Sewer Jetting	34
RKIS30...	KUKA - COUPLINGS	Inserts	35
RKFR12...	KUKA - COUPLINGS	Ferrules	36
SH244	ACCORDION	Sweeper Hose	37
FVH145	FOGNA	Vacuum Truck Hose	38
TSC22	LAGINA/C	S.E. Medium Duty S&D CORRUGATED EXT. HELIX (-30 °C)	39
TSX32	KNIDOS/C	S.E. Medium Duty S&D CORRUGATED EXT. HELIX (-40 °C)	40

Fire Fighting • Feuerweherschläuche • Antincendio • Lutte contre l'incendie



FE586	GHOST	Fire Extinguisher	42
FF581	MILAS-15	Fire Fighting Hose EN 1947:2002-1/ CAT.I TYPE A-CLASS 1	43
FF584	MILAS-40	Fire Fighting Hose EN 1947:2002-1/ CAT.II TYPE C-CLASS 1	44
TBY71-72	FIRE REEL	Thermorub® Fire Reel	45
HTB541	FUMO	Textile Braided CO ₂	46

Air - Gas • Luft - Gas • Aria - Gas • Air - Gaz



LL/ALDO81	LONG-KOMP10 BAR	Light Duty Air	48
LL/ALDO84	LONG-KOMP20 BAR	Medium Duty Air	49
LL/ASO84	LONG-KOMP A/S	Medium Duty Air ANTISTATIC	50
LLMP225	LONG-MULTI	Multipurpose	51
LLMPC225	PRIME	Multipurpose EPDM	52
ALDO81	SKY-10	Light Duty Air	53
AMDO84	SKY-20	Medium Duty Air	54
AHD225	SKY-25	Heavy Duty Air	55
ASW205	MOON-40	Steel Wire Reinforced Air	56
ADS240	MARS	Dust and Air Suction	57
UL-HWB313	ULTIMATE 1SN	1 Steel Wire Braid - High Temperature - +135 °C	58
UL-HWB323	ULTIMATE 2SN	2 Steel Wire Braid - High Temperature - +135 °C	59
UL-HWB351	ULTIMATE R5	1 Steel Wire Braid - High Temperature - +135 °C	60
UL-HTB362	ULTIMATE R6	1 Textile Braid - High Temperature - +135 °C	61
NH225	NITRO-20	Nitrogen Hose	62

I N D E X

Code	Product Name	Application	Page
------	--------------	-------------	------

Welding • Schweißen • Saldatura • Soudure



WH210	JUPITER-ISO 3821	Welding (Oxygen-Acetylene)	64
TWH210	JUPITER TWIN-ISO 3821	Welding (Oxygen-Acetylene)	65
WHB211	JUPITER-ASTM C 542	Welding (Oxygen-Acetylene)	66
LPGW270	URANUS	LPG Welding	67

Hot Water • Heisswasser • Acqua Calda • Eau Chaude



LL/HH100	ISI L/L	Car Heater - Radiator	70
LL/HC105	HEATER L/L	Car Heater LOW OIL RESISTANCE	71
RAD 100	ISI RAD	Radiator	72
HWD160	ISI -10	Hot Water	73
HWSD163	ISI SD/10	Hot Water S&D	74
HWC164	ISI SDC	Hot Water S&D CORRUGATED	75
HWC164	ISI-SDFC	Hot Water S&D FLAT CORRUGATED	76
HWGR16K	ISI-GR	Hot Water S&D CHANNELED	77
HWGF16C	ISI GF	Glass Fibre Cover Hot Water	78

Steam • Dampf • Vapore • Vapeur



ST511	BUHAR 170	Textile Steam	80
ST560	BUHAR - 1A	Textile Steam ISO 6134-1A	81
ST561	BUHAR - 1B	Textile Steam ISO 6134-1B - Oil Resistant Cover	82
SSW513	BUHAR SW	Steel Wire Reinforced Steam 200 °C	83
SSW563	GEYSER-2A	Steel Wire Reinforced Steam 210 °C ISO 6134-2A	84
SSW564	GEYSER-2B	Steel Wire Reinforced Steam 210 °C OIL RESISTANT COVER-ISO 6134-2B	85
FSDD881	BUHAR DW	Dairy Steam-Wash	86

Hot Air Blower • Heißluft- Kompressor • Aria Calda • Air Chaud



HABH507	ALIZE 200 °C	Hot Air Blower	92
HABSD508	ALIZE SD 200 °C	Hot Air Blower S&D	93

Material Handling • Abriebfeste Schläuche • Prodotti Abrasivi • Produits Abrasifs



ABSB711	KUM	Sandblast 60mm³	96
ABSA711	KUM +	Sandblast 35mm³	97
ABSB716	KUM AMERICA 2	Sandblast 2 Ply 60mm³	98
ABSB717	KUM AMERICA 4	Sandblast 4 Ply 60mm³	99
ABSF720	SILOBAS	Cement Flat	100
CDS731	CEMDRY	Dry Cement Discharge	101
ABC731	CIMENTO	Cement Discharge	102
ABCSD740	CIMENTO SD-5	Cement S&D 5 Bar	103
ABCSD741	CIMENTO SD-10	Cement S&D 10 Bar	104
ABCC744	CIMENTO SDC	Cement S&D CORRUGATED	105
ABCGR726	CIMENTO GR	Cement S&D CHANNELED	106
CVH227	VIBRA	Concrete Vibration Hose	107
ABFH744	FRAME	Bulk Material S&D Hose	108
ABPP751	SIVA 40	Plaster&Grout Spraying	110
ABCP752	SIVA 85	Plaster&Grout Spraying	111
ABUC760	BETON UC 85	Steel Wire Reinforced Concrete Pumping	112

I N D E X

Code	Product Name	Application	Page
------	--------------	-------------	------

Material Handling • Abriebfeste Schläuche • Prodotti Abrasivi • Produits Abrasifs



TSA80	LYMRA HD-PU	Heavy Duty Antiabrasive S&D PU LINING	114
ABPT070	PARATUB	Abrasion-Paratub	115
ABPL790	PARARUB L	Abrasion-Pararub	116
ABPSD791	PARARUB SD	Abrasion S&D Pararub	117
ABPC792	PARARUB SDC	Abrasion S&D Pararub CORRUGATED	118
ABPGR793	PARARUB GR	Abrasion S&D Pararub CHANNELED	119
ABRF742	TOTEM MH	Material Handling Rubber Beaded End with Flange	120

Food • Lebensmittel Schläuche • Prodotti Alimentari • Produits Alimentaires



FDPW811	SPRING D/10	Potable Water Delivery	122
FSDPW821	SPRING SD/10	Potable Water S&D	123
MT861	MITANK D/6	Milk Delivery	124
MT871	MITANK SD/6	Milk Suction & Delivery	125
FDM861	KREMA D/10	Milk & Vegetable Oil Delivery	126
FSDM871	KREMA SD/10	Milk & Vegetable Oil S&D	127
FDBW800	MEY D/6 -10	Beer & Wine Delivery	128
FSDBW801	MEY SD/6 -10	Beer & Wine S&D	129
FDNR831	NATUR D/6 -10	Foodstuff Delivery NR	130
FSDNR841	NATUR SD/6 -10	Foodstuff S&D NR	131
FDPE802	RAKI D/10 PE	Foodstuff Delivery UHMW-PE	132
FSDPE803	RAKI SD/10 PE	Foodstuff S&D UHMW-PE	133
FFC80F	RAKI SDFC/10 PE	Foodstuff S&D UHMW-PE FLAT-CORRUGATED	134

Abrasive Food • Abriebfester Lebensmittelschläuche • Prodotti Abrasivi Alimentari • Produits Abrasifs Alimentaires



ABFL248	WHITE L	Light Duty Bulk Food Delivery FLAT	136
ABFHD249	WHITE HD	Heavy Duty Bulk Food Delivery	137
ABFSD848	WHITE HD/SD	Heavy Duty Bulk Food S&D	138
ABFC849	WHITE SDC	Heavy Duty Bulk Food S&D CORRUGATED	139
ABFC84F	WHITE SDFC	Heavy Duty Bulk Food S&D FLAT-CORRUGATED	140
ABFGR850	WHITE GR	Heavy Duty Bulk Food S&D CHANNELED	141

Oil & Petroleum • Öl und Kraftstoff • Prodotti Petroliferi • Hydrocarbures



OD441	YAKIT/10	Oil Discharge 10 Bar	144
OSD451	YAKIT SD/10	Oil S&D 10 Bar	145
OC454	YAKIT SDC/10	Oil S&D 10 Bar CORRUGATED	146
OSDFC45F	YAKIT FC-10	Oil S&D 10 Bar FLAT-CORRUGATED	147
OGR456	YAKIT GR-10	Oil S&D 10 Bar CHANNELED	148
ODH441	YAKIT/16	Oil Discharge 16 Bar	149
OSDH451	YAKIT SD/16	Oil S&D 16 Bar	150
ODH441	BARREL/16	Oil Discharge 16 Bar EN 1360 Type 1	151
OSDH451	BARREL SD/16	Oil S&D 16 Bar EN 1360 Type 2	152
FDH44S	FOSSIL D/16	Oil Discharge 16 Bar EN 1761 Type D	153
FSDH45S	FOSSIL SD/16	Oil S&D 16 Bar EN 1761 Type SD	154
ODEN447	YAKIT-EN 12115 / D16	Oil Discharge 16 Bar EN 12115 Type D	155
OSDEN448	YAKIT-EN 12115 / SD16	Oil S&D 16 Bar EN 12115 Type SD	156
R4341	SELTEX R4	Textile Hydraulic R4	157
R434E	SELTEX ECO	Textile Hydraulic R4E	158
R434F	SELTEX R4-X	Textile Hydraulic R4-X X-Flexibility	159
UL-R4341	ULTIMATE R4	Textile Hydraulic R4 - High Temp. +135°C	160

I N D E X

Code	Product Name	Application	Page
------	--------------	-------------	------

Oil & Petroleum • Öl und Kraftstoff • Prodotti Petroliferi • Hydrocarbures



DOH 459/460	LIMAN	Dock Oil EN 1765 Type S	161
PSD459	LIMAN - S10	Swaged Flanges EN 1765 Type S10	162
PSD41S	LIMAN - S10	Built-In Flanges EN 1765 Type S10	163
PSD460	LIMAN - S15	Swaged Flanges EN 1765 Type S15	164
PSD417	LIMAN - S15	Built-In Flanges EN 1765 Type S15	165
ASF401	ASPHALT	Asphalt S&D	166
ARB495	AERO-B	Aircraft Refueling EN 1361 Type B	167
ARC-H494	AERO-C	Aircraft Refueling EN 1361 Type C	168
ARE496	AERO-E	Aircraft Refueling EN 1361 Type E	169
LPGD 278/27D	LPG - D	LPG Discharge-Ω EN 1762	170
LPGSD 279/27S	LPG - SD	LPG S&D-Ω EN 1762	171
ONT020	OIL TUBE	Oil Nitrile Tube	172
OTR445	TEXTOIL/10 NL-20 NL	Textile Reinforced Oil 10 NL - 20 NL	173
OETB471	COTTON OIL - B	Oil DIN 73379 Type B	174
ODIN 1A/461	OIL - 1A	Oil DIN 73379 Type 1A	175
ODIN 2A/462	OIL - 2A	Oil DIN 73379 Type 2A	176
ODIN 2B/463	OIL - 2B	Oil DIN 73379 Type 2B	177
GWO481	GALVOIL/L	Galvanized Wire Braided Oil	178

Petroleum Dispensing • Tankstellenzapfschläuch • Distribuzione del Carburante • Distribution Carburant



OPL441	POMPA / L	Petrol Pump -30 °C	180
OPL44U	POMPA / L+	Petrol Pump U _L -54 °C	181
OPSW430	POMPA SWB	Petrol Pump Steel Wire Braided -30 °C	182
OPSW43U	POMPA SWB+	Petrol Pump Steel Wire Braided U _L -54 °C	183

Chemical • Chemie • Prodotti Chimici • Produits Chimiques



AD611	KEMI D/10 EPDM	Chemical Delivery EPDM	186
ASD621	KEMI SD/10 EPDM	Chemical S&D EPDM	187
AC624	KEMI 10 / SDC EPDM	Chemical S&D EPDM CORRUGATED	188
EPD601	KEMI D/16 EPDM	Chemical Delivery EPDM EN 12115	189
EPSD602	KEMI SD/16 EPDM	Chemical S&D EPDM EN 12115	190
AHCD631	KEMI D/10 CSM	Chemical Delivery CSM	191
ACSD641	KEMI SD/10 CSM	Chemical S&D CSM	192
XLPED671	KEMI D/10 XLPE	Acid-Solvent & Chemical Delivery XLPE	193
XLPESD681	KEMI SD/10 XLPE	Acid-Solvent & Chemical S&D XLPE	194
XLPEFC68F	KEMI SDFC/10 XLPE	Acid-Solvent & Chemical S&D XLPE-FLAT-CORR.	195
XLD655	KEMI D/16 XLPE	Acid-Solvent & Chemical Delivery XLPE-EN 12115	196
XLSD656	KEMI SD/16 XLPE	Acid-Solvent & Chemical S&D XLPE-EN 12115	197
UHMWPE609	KEMI D/10 UHMW-PE	Acid-Solvent & Chemical Delivery UHMW-PE	198
UHMWPES610	KEMI SD/10 UHMW-PE	Acid-Solvent & Chemical S&D UHMW-PE	199
UHMWPEC608	KEMI SDC/10 UHMW-PE	Acid-Solvent & Chemical S & D UHMW-PE - CORR.	200
UHD658	KEMI D/16 UHMW-PE	Acid-Solvent & Chemical D. UHMW-PE - EN 12115	201
UHSD659	KEMI SD/16 UHMW-PE	Acid-Solvent & Chemical S&D UHMW-PE - EN 12115	202
ABSF623/63/83	STATUE CH	Chemical Hose With Built -in Flanges	203
CRF622	STATUE CRF	Chemical Hose With Rubber Beaded-End with Flange	204

I N D E X

Code	Product Name	Application	Page
------	--------------	-------------	------

Cable Protection • Kabelschutz • Protezione Cavi • Gaines de Protections



CP137	KABLO PE	Cable Protection for Electrical Welding	206
CP137	KABLO FL	Cable Protection for Electrical Welding	207
TES137	KABLO RW	Electrical Cable Protection for Trains	208
MC035	MAESTRO	Mining Conduit Hose (non reinforced)	209
MC035	MAESTRO R	Mining Conduit Hose (reinforced)	210
CFH851	BLANCO	Insulating Hose for Cable	211

Steel Mill • Stahlwerk • Acciaieria • Aciérie



CBH703	CARBON	Carbon Blower Hose	214
CPH110	EGE GF	Glass Fibre Cover Water Out. Temp. up to 600 °C	215
CWH855	OSTRO	Nonflammable-Cooling Hose	216
CWFG857	OSTRO GF	Glass Fibre Cover Cooling Water Out. Temp. up to 600 °C	217
CWFG854	OSTRO 2GF	2 Glass Fibre Cover Cooling Water Out. Temp. up to 600 °C	218
CWFG125	OSTRO FLANGED	2 Glass Fibre Cover Cooling Water with Built in Flange Out. Temp. up to 600 °C	219
HWCC115	ISI CC	Ceramic Coated Cover Hot Water	220
SGF521	BUHAR GF	Glass Fibre Cover Steam Out. Temp. up to 600 °C	221

Silicone • Silikon • Silicone • Silicone



SD950	SIROCCO	Silicone Cooling	224
SDD961	SIROCCO - SD	Silicone Cooling S&D	225

Oil Rigs Platform • Ölplattform • Piattaforme Petroliere • Plateformes Pétrolières

OFF-SHORE









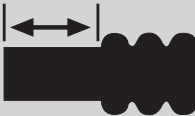

RS225	OSRIS - FD	Soft Wall Oil / Fuel Delivery	228
RS115	OSRIS - WD	Soft Wall Water Delivery	229
RS455	OSRIS - FSD	Hard Wall Oil / Fuel Suction & Delivery	230
RS715	OSRIS - MD	Soft Wall Bulk Material Delivery	231
RS725	OSRIS - MSD	Hard Wall Bulk Material Suction & Delivery	232
RS735	OSRIS - LMD	Soft Wall Liquid Mud Delivery	233
RS745	OSRIS - LMSD	Hard Wall Liquid Mud Suction & Delivery	234
RS835	OSRIS - PW	Soft Wall Potable Water Delivery	235
RS845	OSRIS - PWSD	Hard Wall Potable Water Suction & Delivery	236
RS685	OSRIS - CHSD	Hard Wall Chemical Suction & Delivery XLPE	237
RS610	OSRIS - PE	Hard Wall Chemical Suction & Delivery UHMWPE	238

Info • Info • Info • Info

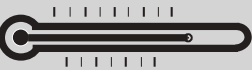

Conversion Chart	240
Pressure Conversion Table	241
Vacuum Conversion Table	242
Chemical Resistance Chart	243
Use - Maintenance - Conservation - Shipment & Storage	243
Sales Terms & Conditions	244
Benutzung - Wartung - Sicherung - Transport und Lagerung	248
Allgemeine Geschäftsbedingungen	249
Uso - Manutenzione - Protezione - Trasporto e Magazzinaggio	250
Termini e Condizioni Di Vendita	251
Utilisation - Entretien - Protection - Livraison et Stockage	252
Termes et Conditions de Vente	253

Symbols/Symbols/Simboli/Symboles

 ID	INNER DIAMETER INNENDURCHMESSER DIAMETRO INTERNO DIAMETRE INTERIEUR		CUFFED END MUFFEN MANICOTTI MANCHETTE
 OD	OUTER DIAMETER AUSSENDURCHMESSER DIAMETRO ESTERNO DIAMETRE EXTERIEUR	 VACUUM	VACUUM VAKUUM ASPIRAZIONE DEPRESSION
 WP	WORKING PRESSURE BETRIEBSDRUCK PRESSIONE D'ESERCIZIO PRESSION DE SERVICE	 Br/r	BENDING RADIUS BIEGERADIUS RAGGIO CURVATURA RAYON DE COURBURE
 BP	BURST PRESSURE PLATZDRUCK PRESSIONE DI SCOPPIO PRESSION D'ECLATEMENT	 W	THEORETICAL WEIGHT THEORETISCHES GEWICHT PESO TEORICO MASSE LINEAIRE
	WORKING TEMPERATURE BETRIEBSTEMPERATUR TEMPERATURA DI LAVORO TEMPERATURE DE TRAVAIL	 L	LENGTH LÄNGE LUNGHEZZA LONGUEUR

Tolerances/Toleranzen Tolleranze/Tolérances

Acc. ISO 1307

Weight : ± 5 % (All dimensions)

Gewicht : ± 5 % (Alle dimensionen)

Peso : ± 5 % (Tutte le dimensioni)

Poids : ± 5 % (Tous les diametres)

★ OTHER COLOURS AND DIAMETERS AVAILABLE UPON REQUEST.

★ AUF ANFRAGE KÖNNEN VERSCHIEDENE FARBEN UND MASSE PRODUZIERT WERDEN.

★ DIVERSI COLORI E DIMENSIONI DISPONIBILI SU RICHIESTA.

★ D'AUTRES COULEURS ET DIAMETRES DISPONIBLES SUR DEMANDE.

Burst Pressure : 10% deviation

Berstdruck kann : 10% abweichen

Pressione di scoppio : deviazione 10%

Pression d'éclatement: 10 déviation

For material handling hoses

Abrasion Loss Value: ± 10 mm³ deviation

Abrieb-Wert : ± 10 mm³ möglich

Perdita d'Abrasione : deviazione ±10 mm³

Indice d'abrasion : ± 10 mm³ déviation

★ For further details please contact our sales department.

★ Für die weitere informationen steht unser Verkaufsteam Ihnen jederzeit zur Verfügung.

★ Per l'informazione dettagliata prego di contattarci con il dipartimento di vendita.

★ Pour plus de détails s'il vous plaît contactez notre service commercial.

★ Our company reserves the right of changing hose construction specifications due to technologic obligations and developments.

★ Unsere Firma behält sich das Recht vor, ohne vorherige Ankündigung Änderungen an den technischen Eigenschaften und Abmessungen der Schläuche vorzunehmen, die der Qualitätsverbesserung und Weiterentwicklung dienen.

★ La nostra firma si riserva la facoltà di modificare tutto o in parte il presente catalogo; declina inoltre ogni responsabilità per utilizzi dei propri prodotti diversi da quelli indicati.

★ Notre société se réserve le droit de changer les spécifications de construction en raison des obligations et des développements technologiques.

TECHNICAL HOSE ENDS & COUPLINGS



SWAGED FITTINGS GENERALLY, USED ON INDUSTRIAL APPLICATIONS, ESPECIALLY PETROLEUM SUCTION AND DISCHARGE, AS AN ALTERNATIVE TO BUILT-IN FLANGED HOSES. THE NIPPLE AND FERRULE ARE SWAGED TO THE HOSE AS AN INTEGRATED UNIT. IN THIS WAY, PROBLEMS, SUCH AS LEAKAGE BLOWING ETC. CAN BE PREVENTED EFFECTIVELY.



EINGEPRESSTE KUPPLUNGEN DIESES SYSTEM BESTEHT AUS EINER STÜTZE UND EINER HÜLSE, DIE ALS INTEGRIERTE EINHEIT AUF DEN SCHLAUCH AUFGEPRÉSST WERDEN. DIESE EINHEIT VERSCHAFFT EINE AUßERORDENTLICHE HALTKRAFT, DIE DAS HERAUSRÜCKEN DER KUPPLUNG VERHINDERT.



RACCORDI PRESSATI GENERALMENTE UTILIZZATI IN APPLICAZIONI INDUSTRIALI, SPECIALMENTE NEI TUBI PER ASPIRAZIONE E MANDATA DI PRODOTTI PETROLIFERI, COME ALTERNATIVA AI TUBI CON RACCORDI VULCANIZZATI. IL CODOLO E LA GHIERA È PRESSATO SUL TUBO COME UN'UNITÀ INTEGRATA. IN QUESTO MODO, PROBLEMI COME LA PERDITA, ROTTURA, ETC. POSSONO ESSERE PREVENUTE CON EFFICACIA.



RACCORDS SERTIS GÉNÉRALEMENT, UTILISÉ DANS LES APPLICATIONS INDUSTRIELLES, EN PARTICULIER POUR L'ASPIRATION ET REFOULEMENT DES PRODUITS PÉTROLIERS, EN ALTERNATIVE AUX TUYAUX AVEC DES RACCORDS VULCANISÉS. LA DOUILLE ET LA JUPE SONT SERTIES SUR LE TUYAU COMME UNE UNITÉ INTÉGRÉE. DE FAÇON À CE QUE LES PROBLÈMES DE FUITES OU D'ÉCLATEMENT SOIENT ÉVITÉS.



VULCANIZED BUILT IN FLANGE HOSE END IS INTEGRALLY BUILT AROUND NIPPLE AND VULCANIZED. IN THIS WAY, PROBLEMS, SUCH AS LEAKAGE BLOWING ETC. CAN BE PREVENTED EFFECTIVELY.



EINVULKANISIERTE KUPPLUNGEN DER STUTZEN WIRD IN DAS SCHLAUCHENDE EINGESETZT. NACH DER VULKANISIERUNG WERDEN DIESE ZU EINER UNZERTRENNLICHEN EINHEIT. DADURCH KANN DER STUTZEN NICHT MEHR AUS DEM SCHLAUCH HERAUSGEDRÜCKT WERDEN. DIESES SYSTEM VERHINDERT JEGLICHE ART VON PLATZEN ODER LECKEN DES SCHLAUCHES.



RACCORDO VULCANIZZATO L'ESTREMITÀ DEL TUBO È INTEGRALMENTE COSTRUITO INTORNO AD UN CODOLO E VULCANIZZATO. IN QUESTO MODO, PROBLEMI COME LA PERDITA, ROTTURA, ETC. POSSONO ESSERE PREVENUTE CON EFFICACIA.



RACCORDS VULCANISÉS L'EXTRÉMITÉ DU TUYAU EST INTÉGRALEMENT CONSTRUITE AUTOUR D'UNE DOUILLE ET VULCANISÉE. DE CETTE FAÇON, LES PROBLÈMES, COMME LES FUITES, ÉCLATEMENT ETC PEUVENT ÊTRE ÉVITÉES DE MANIÈRE EFFICACE.



SOFT END THE HELIX WIRE IS TERMINATED BEFORE END OF THE HOSE FOR EASY COUPLING TO ENSURE THE STRENGTH, HOSE END IS REINFORCED WITH RUBBER AND TEXTILE.



SPIRALFREIE MUFFEN ZUR VEREINFACHUNG DER VERKUPPLUNG ENDET DIE SPIRALE EINIGE WINDUNGEN VOR DER ENDWULSTE DES SCHLAUCHES. DIE MUFFE SELBST WIRD ZUSÄTZLICH DURCH EINE GEWEBEEINHEIT VERSTÄRKT, DADURCH WIRD DIE EIGENSCHAFT DES SCHLAUCHES NICHT BEEINTRÄCHTIGT.



MANICOTTO LA SPIRALE VIENE FERMATA PRIMA DELL'ESTREMITÀ DEL TUBO PER FACILITARE IL MONTAGGIO DEI RACCORDI. PER GARANTIRE LA FORZA, L'ESTREMITÀ DEL TUBO È RINFORZATO CON GOMMA E TESSILE.



MANCHETTE SOUPLE LA SPIRALE EST ARRÊTÉE AVANT L'EXTREMITÉ DU TUYAU POUR FACILITER LE MONTAGE DES RACCORDS. AFIN D'ASSURER LA TENUE À LA PRESSION DU RACCORD L'EXTREMITÉ DU TUYAU EST RENFORCÉE AVEC DU CAOUTCHOUC ET TEXTILES.



ENLARGED CUFFS THE HOSE END IS ENLARGED TO FIT THE OUTSIDE DIAMETER OF INSERT OF A FITTING. THE HELIX WIRE IS TERMINATED AT THE ENLARGED END.



ERWEITERTE MUFFEN DER INNENDURCHMESSER DES SCHLAUCHES WIRD ERWEITERT GEFERTIGT, UM DEM AUSSENDURCHMESSER DES KUPPLUNGSTUTZES ANZUPASSEN.



BOCCA ALLARGATA L'ESTREMITÀ DEL TUBO È ALLARGATA PER PERMETTERE L'INSERIMENTO DEL RACCORDO. LA SPIRALE VIENE FERMATA PRIMA DELL'ESTREMITÀ DELLA BOCCA ALLARGATA.



MANCHETTE EVASÉE L'EXTRÉMITÉ DU TUYAU EST ÉLARGIE POUR L'ADAPTATION AU DIAMÈTRE EXTÉRIEUR DU RACCORD À MONTER. LA SPIRALE EST ARRÊTÉE AVANT L'EXTREMITÉ DE LA MANCHETTE EVASÉE.



TECHNICAL HOSE ENDS & COUPLINGS



RUBBER BEADED ENDS WITH FLANGES THE REINFORCING TEXTILE AND AN ADDITIONAL CIRCULAR METAL REINFORCEMENT IS EMBEDDED INSIDE THE RUBBER MOLDED BEAD AS AN INTEGRAL PART OF THE HOSE. A REATTACHABLE SWIVEL METAL FLANGE IS PLACED BEHIND THE RUBBER BEAD. THIS SYSTEM PROVIDES AN EASY CONNECTION WITHOUT ANY ADDITIONAL GASKETS AND NO CONTACT BETWEEN FLANGES AND TRANSPORTED PRODUCTS (RUBBER TO RUBBER).



ENDWULSTE MIT FLANSCHRINGEN UM DEN SCHLAUCH MIT DER ENDWULSTE VERBINDEN ZU KÖNNEN, MUSS DIE FLANSCH JUSTIERT WERDEN. JEDOCH OHNE DEN SCHLAUCH VERDREHEN ZU MÜSSEN. DIES LIEGT DARAN, DASS AN DER ENDWULSTE DES SCHLAUCHES EIN METALLRING VERARBEITET IST, DER DAS MONTIEREN DES FLANSCHRINGES ERHEBLICH VEREINFACHT UND DAS VERSCHIEBEN VERHINDERT. DADURCH KOMMT EIN GUMMI-AUF-GUMMI- VERSCHLUSS ZUSTANDE UND BILDEN EINEN LECKSICHEREN VERSCHLUSS, DER KEINE DICHTUNG MEHR BENÖTIGT.



TALLONE DI GOMMA CON FLANGE IL RINFORZO TESSILE E DI UN ULTERIORE RINFORZO DI METALLO CIRCOLARE È INCORPORATO ALL'INTERNO DELLA GOMMA STAMPATA COME PARTE INTEGRANTE DEL TUBO. UNA FLANGIA GIREVOLE IN METALLO SI TROVA DIETRO IL TALLONE DI GOMMA. QUESTO SISTEMA FORNISCE UNA FACILE CONNESSIONE SENZA GUARNIZIONI SUPPLEMENTARI ET NESSUN CONTATTO TRA FLANGE E TRASPORTATO PRODOTTI (GIUNZIONE GOMMA / GOMMA)



TALLON EN CAOUTCHOUC ET BRIDES TOURNANTES LE RENFORCEMENT TEXTILE DU TUYAU ET UN ANNEAU MÉTALLIQUE SUPPLÉMENTAIRE EST INCORPORÉ DANS LE TALON EN CAOUTCHOUC MOULÉ COMME UNE PARTIE INTÉGRANTE DU TUYAU. UNE BRIDE EN ACIER TOURNANTE VIENT ENSUITE S'APPUYER SUR LE TALON. CE SYSTÈME FOURNIT UNE ETANCHEITE PARFAITE, SANS NECESSITE DE JOINT SUPPLEMENTAIRE ET AUCUN CONTACT ENTRE LA BRIDE TOURNANTE ET LES PRODUITS TRANSPORTES (JOINTURE CAOUTCHOUC SUR CAOUTCHOUC).

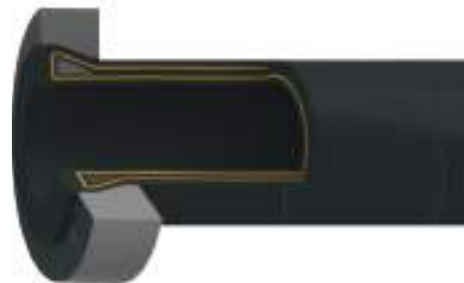

BOLTED CLAMPS NIPPLE AND EXTERNAL CLAMPS ARE FASTENED TO THE HOSE WITH BOLTS.



KUPPLUNGEN MIT HALBSCHALEN DIESE VERBINDUNG BESTEHT AUS EINEM STUTZEN UND EINER BANDSCHELLE. DIESE WERDEN MANUELL AN DEN SCHLAUCH FIXIERT UND KÖNNEN DADURCH UNLÖSBAR UND SCHNELL MONTIERT WERDEN.



RACCORDI CON CLAMPE IMBULLONATE CODOLO E CLAMPE ESTERNI SONO FISSATE AL TUBO CON BULLONI.



RACCORDS AVEC COQUILLES A BOULONS UNE DOUILLE ET DES COQUILLES EXTERIEURES SONT FIXÉES AU TUYAU AVEC DES BOULONS.



CAPPED END HOSE END IS COMPLETELY SEALED WITH RUBBER.



GUMMIERTE ENDEN DIE SCHLAUCHENDEN BESTEHEN LEDIGLICH AUS KAUTSCHUK.



RANELLA IN GOMMA L'ESTREMITA DI TUBO E COMPLETAMENTE RICOPERTA DI GOMMA.



MANCHETTE PROTEGEE L'EXTREMITÉ DU TUYAU EST COMPLETEMENT ENVELOPEE AVEC DU CAOUTCHOUC.



NOZZLEEND THE INSIDE AND OUTSIDE DIAMETER OF THE HOSE END ARE GRADUALLY TAPERED DOWN TO FORM A NOZZLE. REINFORCEMENT ARE EXTENDED TO THE END OF THE NOZZLE.



KUPPLUNGEN MIT HALBSCHALEN DER INNEN- UND AUSSENDURCHMESSER DES SCHLAUCHES REDUZIERT SICH ZU EINER GUMMIDUESE MIT TEXTILEVERSTAERKUNG BIS ZUM SCHLAUCHENDE.



LANCIA IL DIAMETRO INTERNO ET ESTERNO DEL TUBO FLESSIBILE SONO GRADUALMENTE RIDOTTO FINO A FORMARE UNA LANCIA. RAFFORZAMENTO SONO ESTESE FINO ALLA FINE DELLA LANCIA.



MANCHETTE EFFILEE LE DIAMÈTRE INTÉRIEUR ET EXTÉRIEUR DU TUYAU SONT PROGRESSIVEMENT RÉDUITES POUR FORMER UNE MANCHETTE EFFILEE. LE RENFORCEMENT EST PROLONGÉ JUSQU'À LA FIN DE LA MANCHETTE.



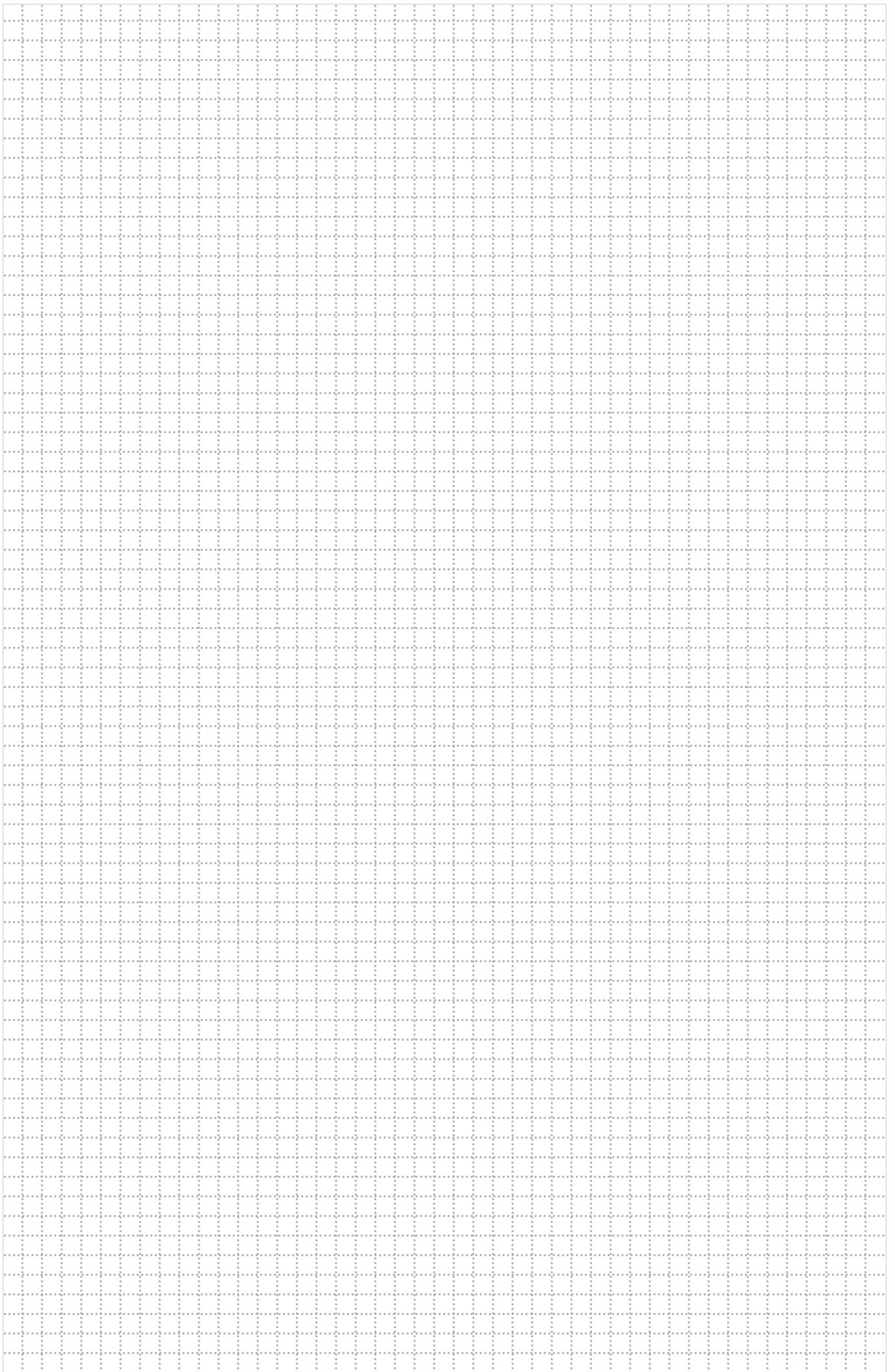

Water

Wasser

Acqua

Eau

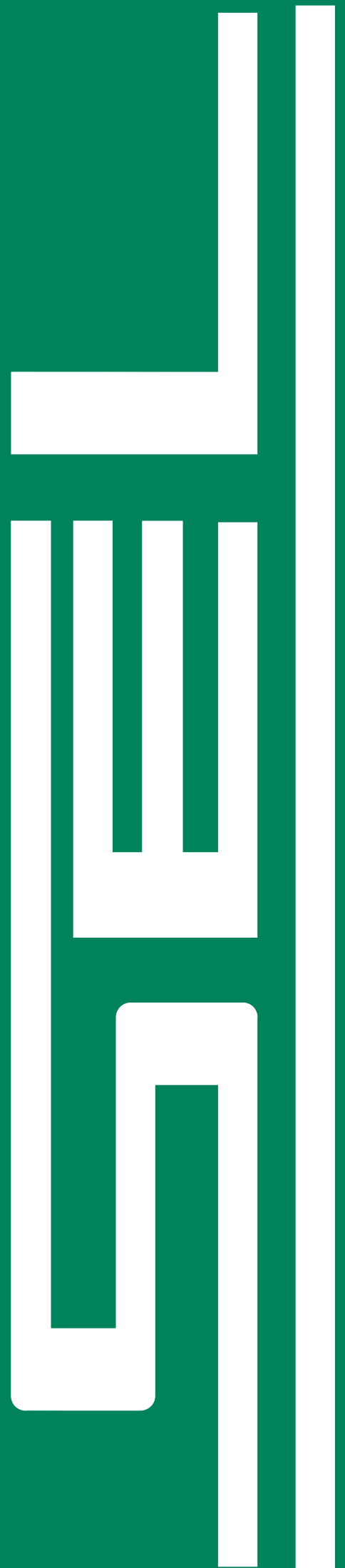

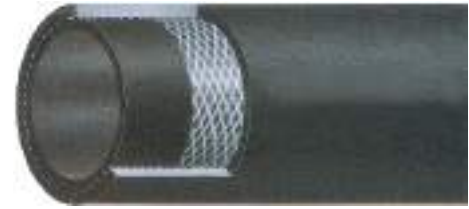

Water



 TUBE : NATURAL AND SYNTHETIC RUBBER.
 REINFORCEMENT : HIGH TENSILE SYNTHETIC TEXTILE.
 COVER : WEATHER AND ABRASION RESISTANT SMOOTH SYNTHETIC RUBBER.
 APPLICATION : GARDENING AND GENERAL WATER DISCHARGE SERVICES.

 SEELE : NATUR- UND SYNTHETISCHER KAUSCHUK.
 EINLAGE : HOCHZUGFESTE SYNTHETISCHE EINLAGE.
 DECKE : GLATT, WETTER- UND ABRIEFESTER SYNTETHISCHER GUMMI.
 ANWENDUNG : FÜR LANDWIRTSCHAFTLICHE BEWÄSSERUNG UND BEFÖRDERUNG VON WASSER.

 SOTTOSTRATO : GOMMA NATURALE E SINTETICA.
 RINFORZO : INSERZIONI TESSILI AD ALTA TENACITÀ.
 COPERTURA : LISCIA IN GOMMA SINTETICA RESISTENTE ALL'ABRASIONE ED AGLI AGENTI ATMOSFERICI.
 IMPIEGO : MANDATA D'ACQUA PER USO GENERALE PER GIARDINAGGIO ED EDILIZIA.

 TUBE : CAOUTCHOUC NATUREL ET SYNTHETIQUE.
 RENFORCEMENT : INSERTION TEXTILE HAUTE TENACITE.
 REVETEMENT : CAOUTCHOUC SYNTHETIQUE RESISTANT A L'ABRASION ET AUX AGENTS ATMOSPHERIQUES.
 APPLICATION : REFOULEMENT D'EAU POUR L'ARROSAGE, NETTOYAGE ETC.

ID		OD	WP		BP		W	L
inch	mm	mm	bar	psi	bar	psi	g/m	m
1/4"	6	11	10	145	30	435	105	100
5/16"	8	14	10	145	30	435	160	100
3/8"	10	16	10	145	30	435	190	100
1/2"	13	19	10	145	30	435	230	100
5/8"	16	23	10	145	30	435	330	100
3/4"	19	27	10	145	30	435	440	100
1"	25	34	10	145	30	435	630	100



-25°C / + 70°C
 -13°F / +158°F

MARKING / BESCHRIFTUNG / MARCATURA / MARQUAGE: **EMBOSSED OR INK JET**

SEL TS EN ISO 1403 Type 2 (SIZE mm) 1.0 MPA (10 BAR) - 145 PSI (YEAR)

NORMS NORMEN NORME NORMES	TS EN ISO 1403/2 ISO 1403/2 ISO 1307	COLOUR FARBEN COLORI COULEUR	
------------------------------------	--	---------------------------------------	--

Low Pressure Water



TUBE : NATURAL AND SYNTHETIC RUBBER.
 REINFORCEMENT : HIGH TENSILE SYNTHETIC TEXTILE.
 COVER : WEATHER AND OZONE RESISTANT SMOOTH SYNTHETIC RUBBER.
 APPLICATION : GARDENING AND GENERAL WATER DISCHARGE SERVICES.



SEELE : NATUR- UND SYNTHETISCHER KAUTSCHUK.
 EINLAGE : HOCHZUGFESTE SYNTHETISCHE EINLAGE.
 DECKE : WETTER - UND OZONBESTÄNDIGER SYNTHETISCHER GUMMI.
 ANWENDUNG : FÜR LANDWIRTSCHAFTLICHE BEWÄSSERUNG UND BEFÖRDERUNG VON WASSER.



SOTTOSTRATO : GOMMA NATURALE E SINTETICA.
 RINFORZO : INSERZIONI TESSILI AD ALTA TENACITÀ.
 COPERTURA : GOMMA SINTETICA RESISTENTE AGLI AGENTI ATMOSFERICI E ALL'OZONO.
 IMPIEGO : MANDATA D'ACQUA PER USO GENERALE PER GIARDINAGGIO ED EDILIZIA.



TUBE : CAOUTCHOUC NATUREL ET SYNTHETIQUE.
 REINFORCEMENT : INSERTION TEXTILE HAUTE TENACITE.
 REVETEMENT : CAOUTCHOUC SYNTHETIQUE RESISTANT A L'OZONE ET AUX AGENTS ATMOSPHERIQUES.
 APPLICATION : REFOULEMENT D'EAU INDUSTRIELLES A LA PRESSION DU RESEAU.

ID		OD	WP		BP		W	L
inch	mm	mm	bar	psi	bar	psi	g/m	m
3/8"	10	17	6	87	18	261	231	40-46
1/2"	12.7	20	6	87	18	261	277	40-46-61
5/8"	16	23	6	87	18	261	322	40-46-61
3/4"	19	26	6	87	18	261	385	40-46-61
1"	25.4	33	6	87	18	261	510	40-46-61
1 1/4"	32	40	6	87	18	261	632	40-46-61
1 1/2"	38	46	6	87	18	261	740	40-46-61
1 3/4"	44.5	53	6	87	18	261	930	40-46-61
2"	50.8	60	6	87	18	261	1195	40-46-61
2 1/2"	63.5	73	6	87	18	261	1491	40-46-61
2 3/4"	70	80	6	87	18	261	1750	40-46-61
3"	76.2	86	6	87	18	261	1811	40-46-61
4"	101.6	112	6	87	18	261	2545	40-46-61
5"	127	139	6	87	18	261	3555	40-46-61
6"	152.4	165	6	87	18	261	4634	40-46-61
8"	203.2	218	6	87	18	261	7320	20-40
10"	254	270	6	87	18	261	9450	20



-25°C / + 70°C
 -13°F / +158°F

MARKING / BESCHRIFTUNG / MARCATURA / MARQUAGE: **TRANSFER TAPE OR EMBOSSED**



EGE - 6

LOW PRESSURE WATER HOSE / TS - EN ISO 1403 Type 1 W.P. 6 Bar (87 PSI)



NORMS
 NORMEN
 NORME
 NORMES

TS EN ISO 1403/1
 ISO 1403/1
 ISO 1307

COLOUR
 FARBEN
 COLORI
 COULEUR





Medium Pressure Water



 TUBE : NATURAL AND SYNTHETIC RUBBER.
 REINFORCEMENT : HIGH TENSILE SYNTHETIC TEXTILE.
 COVER : WEATHER AND OZONE RESISTANT SYNTHETIC RUBBER.
 APPLICATION : INDUSTRIAL AND CONSTRUCTION SERVICES, WITH MEDIUM PRESSURE REQUIREMENT.

 SEELE : NATUR- UND SYNTHETISCHER KAUSCHUK.
 EINLAGE : HOCHZUGFESTE SYNTHETISCHE EINLAGE.
 DECKE : WETTER - UND OZONBESTÄNDIGER SYNTHETISCHER GUMMI.
 ANWENDUNG : ZUR VERWENDUNG IN INDUSTRIE UND BAU; MIT MITTLEREN DRUCKANFORDERUNGEN.

 SOTTOSTRATO : GOMMA NATURALE E SINTETICA.
 RINFORZO : INSERZIONI TESSILI AD ALTA TENACITÀ.
 COPERTURA : GOMMA SINTETICA RESISTENTE AGLI AGENTI ATMOSFERICI E ALL'OZONO.
 IMPIEGO : MANDATA D'ACQUA A MEDIA PRESSIONE PER USO INDUSTRIALE ED EDILIZIA.

 TUBE : CAOUTCHOUC NATUREL ET SYNTHETIQUE.
 RENFORCEMENT : INSERTION TEXTILE HAUTE TENACITE.
 REVETEMENT : CAOUTCHOUC SYNTHETIQUE RESISTANT A L'OZONE ET AUX AGENTS ATMOSPHERIQUES.
 APPLICATION : POUR REFOULEMENT D'EAU A PRESSION MOYENNE DANS L'INDUSTRIE ET CONSTRUCTION.



ID		OD	WP		BP		W	L
inch	mm	mm	bar	psi	bar	psi	g/m	m
3/8"	10	17	10	145	30	435	231	40-46
1/2"	12.7	20	10	145	30	435	277	40-46-61
5/8"	16	23	10	145	30	435	322	40-46-61
3/4"	19	27	10	145	30	435	435	40-46-61
1"	25.4	33	10	145	30	435	499	40-46-61
1 1/4"	32	41	10	145	30	435	749	40-46-61
1 1/2"	38	47	10	145	30	435	895	40-46-61
1 3/4"	44.5	54	10	145	30	435	1101	40-46-61
2"	50.8	60	10	145	30	435	1183	40-46-61
2 1/2"	63.5	74	10	145	30	435	1670	40-46-61
2 3/4"	70	82	10	145	30	435	2061	40-46-61
3"	76.2	88	10	145	30	435	2193	40-46-61
4"	101.6	115	10	145	30	435	3286	40-46-61
5"	127	140	10	145	30	435	3861	40-46-61
6"	152.4	165	10	145	30	435	4560	40-46-61
8"	203.2	222	10	145	30	435	8110	20-40-46
10"	254	270	10	145	30	435	10670	20-25



-25°C / + 70°C
 -13°F / +158°F

MARKING / BESCHRIFTUNG / MARCATURA / MARQUAGE: **TRANSFER TAPE OR EMBOSSED**

SEL EGE - 10 MEDIUM PRESSURE WATER HOSE / TS - EN ISO 1403 Type 2 W.P. 10 Bar (145 PSI)  

NORMS NORMEN NORME NORMES	TS EN ISO 1403-2 / ISO 1403-2 ISO 1307	CLOUR FARBEN COLORI COULEUR	 
------------------------------------	---	--------------------------------------	--

Layflat Water



 TUBE : NATURAL AND SYNTHETIC RUBBER
 REINFORCEMENT : HIGH TENSILE SYNTHETIC TEXTILE
 COVER : WEATHER RESISTANT SYNTHETIC RUBBER
 APPLICATION : FOR DISCHARGE OF WATER IN AGRICULTURAL AND INDUSTRIAL APPLICATIONS.

 SEELE : NATUR- UND SYNTHETISCHER KAUTSCHUK.
 EINLAGE : HOCHZUGFESTE SYNTHETISCHE EINLAGE.
 DECKE : WETTER- UND ABRIEBFESTER SYNTHETISCHER GUMMI.
 ANWENDUNG : ZUR VERWENDUNG IN INDUSTRIE UND LANDWIRTSCHAFT.

 SOTTOSTRATO : GOMMA NATURALE E SINTETICA.
 RINFORZO : INSERZIONI TESSILI AD ALTA TENACITÀ.
 COPERTURA : GOMMA SINTETICA RESISTENTE AGLI AGENTI ATMOSFERICI.
 IMPIEGO : PER MANDATA D'ACQUA IN AGRICOLTURA ED INDUSTRIA.

 TUBE : CAOUTCHOUC NATUREL ET SYNTHETIQUE.
 RENFORCEMENT : INSERTION TEXTILE HAUTE TENACITE.
 REVETEMENT : CAOUTCHOUC SYNTHETIQUE RESISTANT AUX AGENTS ATMOSPHERIQUES.
 APPLICATION : REFOULEMENT D'EAU DANS L'INDUSTRIE ET L'AGRICULTURE.

ID		OD	WP		BP		W	L
inch	mm	mm	bar	psi	bar	psi	g/m	m
2"	50.8	56	5	73	15	218	705	40-46-61
2 1/2"	63.5	69	5	73	15	218	871	40-46-61
2 3/4"	70	76	5	73	15	218	1031	40-46-61
3"	76.2	82	5	73	15	218	1090	40-46-61
4"	101.6	108	5	73	15	218	1592	40-46-61
5"	127	134	5	73	15	218	2145	40-46-61
6"	152.4	160	5	73	15	218	2718	40-46-61
8"	203.2	212	5	73	15	218	4160	20-40-46
10"	254	264	5	73	15	218	6035	20-25
12"	304.8	315	5	73	15	218	7075	20-25
14"	355.6	367	5	73	15	218	9035	6
16"	406.4	417	5	73	15	218	10715	6
20"	508	519	5	73	15	218	12205	6



-25°C / + 70°C
 -13°F / +158°F

MARKING / BESCHRIFTUNG / MARCATURA / MARQUAGE: **TRANSFER TAPE OR EMBOSSED**

SEL **FLAT - 5** **LAYFLAT WATER HOSE W.P. 5 Bar (73 PSI)** 

NORMS NORMEN NORME NORMES	ISO 1307	COLOUR FARBEN COLORI COULEUR	
------------------------------------	----------	---------------------------------------	---

High Pressure Layflat Water



 TUBE : NATURAL AND SYNTHETIC RUBBER.
 REINFORCEMENT : HIGH TENSILE SYNTHETIC TEXTILE.
 COVER : WEATHER RESISTANT SYNTHETIC RUBBER.
 APPLICATION : FOR DISCHARGE OF WATER IN AGRICULTURAL AND INDUSTRIAL APPLICATIONS.

 SEELE : NATUR- UND SYNTHETISCHER KAUTSCHUK.
 EINLAGE : HOCHZUGFESTE SYNTHETISCHE EINLAGE.
 DECKE : WETTER- UND ABRIEBFESTER SYNTHETISCHER GUMMI.
 ANWENDUNG : ZUR VERWENDUNG IN INDUSTRIE UND LANDWIRTSCHAFT.

 SOTTOSTRATO : GOMMA NATURALE E SINTETICA.
 RINFORZO : INSERZIONI TESSILI AD ALTA TENACITÀ.
 COPERTURA : GOMMA SINTETICA RESISTENTE AGLI AGENTI ATMOSFERICI.
 IMPIEGO : PER MANDATA D'ACQUA IN AGRICOLTURA ED INDUSTRIA.

 TUBE : CAOUTCHOUC NATUREL ET SYNTHETIQUE.
 RENFORCEMENT : INSERTION TEXTILE HAUTE TENACITE.
 REVETEMENT : CAOUTCHOUC SYNTHETIQUE RESISTANT AUX AGENTS ATMOSPHERIQUES.
 APPLICATION : REFOULEMENT D'EAU DANS L'INDUSTRIE ET L'AGRICULTURE.



CODE: WLF136

inch	mm	mm	bar	psi	bar	psi	g/m	m
2"	50.8	57	10	145	30	435	785	40-46-61
2 1/2"	63.5	70	10	145	30	435	968	40-46-61
2 3/4"	70	77	10	145	30	435	1137	40-46-61
3"	76.2	83	10	145	30	435	1232	40-46-61
4"	101.6	109	10	145	30	435	1785	40-46-61
5"	127	136	10	145	30	435	2650	40-46-61
6"	152.4	162	10	145	30	435	3556	40-46-61
8"	203.2	217	10	145	30	435	6285	20-40-46
10"	254	268	10	145	30	435	8280	20-25

CODE: WLF138

inch	mm	mm	bar	psi	bar	psi	g/m	m
2"	50.8	59	20	290	60	870	1015	40-46-61
2 1/2"	63.5	73	20	290	60	870	1375	40-46-61
2 3/4"	70	79	20	290	60	870	1542	40-46-61
3"	76.2	86	20	290	60	870	1753	40-46-61
4"	101.6	112	20	290	60	870	2307	40-46-61
5"	127	138	20	290	60	870	2990	40-46-61
6"	152.4	163	20	290	60	870	3563	40-46-61



MARKING / BESCHRIFTUNG / MARCATURA / MARQUAGE: **TRANSFER TAPE OR EMBOSSED**



NORMS NORMEN NORME NORMES	ISO 1307	COLOUR FARBEN COLORI COULEUR	
------------------------------------	----------	---------------------------------------	---



Water Suction & Discharge



TUBE : NATURAL AND SYNTHETIC RUBBER.
 REINFORCEMENT : HIGH TENSILE SYNTHETIC TEXTILE AND STEEL HELIX WIRE.
 COVER : ABRASION AND WEATHER RESISTANT SYNTHETIC RUBBER.
 APPLICATION : WATER SUCTION AND DISCHARGE IN INDUSTRIAL AND CONSTRUCTION SERVICES.



SEELE : NATUR- UND SYNTHETISCHER KAUSCHUK.
 EINLAGE : HOCHZUGFESTE SYNTHETISCHE EINLAGE MIT STAHLDRAPTEINLAGE.
 DECKE : WETTER- UND ABRIEFESTER SYNTHETISCHER GUMMI.
 ANWENDUNG : SAUG & DRUCKSCHLAUCH ZUR VERWENDUNG IN INDUSTRIE UND BAUBRANCHE.



SOTTOSTRATO : GOMMA NATURALE E SINTETICA.
 RINFORZO : INSERZIONI TESSILI AD ALTA TENACITÀ E SPIRALE D'ACCIAIO INCORPORATA.
 COPERTURA : GOMMA SINTETICA RESISTENTE ALL'ABRASIONE ED AGLI AGENTI ATMOSFERICI.
 IMPIEGO : ASPIRAZIONE E MANDATA D'ACQUA PER USO INDUSTRIALE ED EDILIZIA.



TUBE : CAOUTCHOUC NATUREL ET SYNTHETIQUE.
 RENFORCEMENT : INSERTION TEXTILE HAUTE TENACITE ET SPIRALE EN ACIER NOYEE.
 REVETEMENT : CAOUTCHOUC SYNTHETIQUE RESISTANT A L'ABRASION ET AUX AGENTS ATMOSPHERIQUES.
 APPLICATION : POUR ASPIRATION ET REFOULEMENT D'EAU DANS L'INDUSTRIE ET CONSTRUCTION.

ID		OD	WP		BP		VACUUM	BR/r	W	L
inch	mm	mm	bar	psi	bar	psi	bar	mm	g/m	m
3/4"	19	28	10	145	30	435	-0.92	70	531	40-46-61
1	25.4	34	10	145	30	435	-0.92	95	635	40-46-61
1 1/4"	32	42	10	145	30	435	-0.92	125	924	40-46-61
1 1/2"	38	48	10	145	30	435	-0.92	150	1165	40-46-61
1 3/4"	44.5	55	10	145	30	435	-0.92	185	1440	40-46-61
2"	50.8	62	10	145	30	435	-0.92	215	1738	40-46-61
2 1/2"	63.5	75	10	145	30	435	-0.92	280	2200	40-46-61
2 3/4"	70	82	10	145	30	435	-0.92	320	2541	40-46-61
3"	76.2	89	10	145	30	435	-0.92	350	2845	40-46-61
4"	101.6	115	10	145	30	435	-0.92	490	3930	40-46-61
5"	127	142	10	145	30	435	-0.80	650	5620	40-46-61
6"	152.4	168	10	145	30	435	-0.80	760	7340	40-46-61
6"	152.4	167	7	102	21	305	-0.80	810	6980	40-46-61
8"	203.2	225	10	145	30	435	-0.80	1120	13650	30
8"	203.2	223	7	102	21	305	-0.80	1220	12690	30
10"	254	279	10	145	30	435	-0.80	1525	18170	10
10"	254	276	7	102	21	305	-0.80	1625	16610	10
12"	304.8	329	10	145	30	435	-0.80	1950	20515	10
12"	304.8	327	7	102	21	305	-0.80	2015	19600	10



-25°C / + 70°C
 -13°F / +158°F

MARKING / BESCHRIFTUNG / MARCATURA / MARQUAGE: **TRANSFER TAPE OR EMBOSSED**

SEL KARADENIZ-10 WATER S/D HOSE W.P. 10 Bar (145 PSI)

NORMS NORMEN NORME NORMES	ISO 1307	COLOUR FARBEN COLORI COULEUR	
------------------------------------	----------	---------------------------------------	--

Heavy Duty Water Suction & Discharge

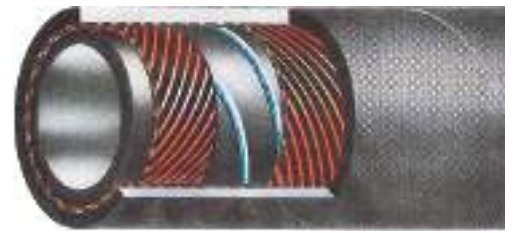

TUBE : NATURAL AND SYNTHETIC RUBBER.
 REINFORCEMENT : HIGH TENSILE SYNTHETIC TEXTILE AND 2 STEEL HELIX WIRE.
 COVER : ABRASION AND WEATHER RESISTANT SYNTHETIC RUBBER.
 APPLICATION : WATER SUCTION AND DISCHARGE IN INDUSTRIAL AND CONSTRUCTION SERVICES.



SEELE : NATUR- UND SYNTHETISCHER KAUTSCHUK.
 EINLAGE : HOCHZUGFESTE SYNTHETISCHE EINLAGE MIT 2 STAHLDRAHTEINLAGE.
 DECKE : WETTER- UND ABRIEBFESTER SYNTETHISCHER GUMMI.
 ANWENDUNG : SAUG & DRUCKSCHLAUCH ZUR VERWENDUNG IN INDUSTRIE UND BAUBRANCHE.



SOTTOSTRATO : GOMMA NATURALE E SINTETICA.
 RINFORZO : INSERZIONI TESSILI AD ALTA TENACITÀ E 2 SPIRALI D'ACCIAIO INCORPORATA.
 COPERTURA : GOMMA SINTETICA RESISTENTE ALL'ABRASIONE ED AGLI AGENTI ATMOSFERICI.
 IMPIEGO : ASPIRAZIONE E MANDATA D'ACQUA PER USO INDUSTRIALE ED EDILIZIA.



TUBE : CAOUTCHOUC NATUREL ET SYNTHETIQUE.
 RENFORCEMENT : INSERTION TEXTILE HAUTE TENACITE ET 2 SPIRALES EN ACIER NOYEE.
 REVETEMENT : CAOUTCHOUC SYNTHETIQUE RESISTANT A L'ABRASION ET AUX AGENTS ATMOSPHERIQUES.
 APPLICATION : POUR ASPIRATION ET REFOULEMENT D'EAU DANS L'INDUSTRIE ET CONSTRUCTION EN SERVICE SEVERE.

ID		OD	WP		BP		VACUUM	BR/r	W	L
inch	mm	mm	bar	psi	bar	psi	bar	mm	g/m	m
3/4"	19	29	16	232	48	696	-0.92	75	572	40-46-61
1	25.4	35	16	232	48	696	-0.92	100	715	40-46-61
1 1/4"	32	42	16	232	48	696	-0.92	130	915	40-46-61
1 1/2"	38	50	16	232	48	696	-0.92	160	1341	40-46-61
1 3/4"	44.5	57.5	16	232	48	696	-0.92	195	1736	40-46-61
2"	50.8	64	16	232	48	696	-0.92	240	1920	40-46-61
2 1/2"	63.5	76.5	16	232	48	696	-0.92	300	2470	40-46-61
2 3/4"	70	84	16	232	48	696	-0.92	340	2785	40-46-61
3"	76.2	90	16	232	48	696	-0.92	380	3050	40-46-61
4"	101.6	118	16	232	48	696	-0.92	525	4855	40-46-61
5"	127	144	16	232	48	696	-0.80	700	6340	40-46-61
6"	152.4	173	16	232	48	696	-0.80	850	9390	40-46-61
8"	203.2	228	16	232	48	696	-0.80	1250	14880	20-30
10"	254	284	16	232	48	696	-0.80	1650	20755	10
12"	304.8	339	16	232	48	696	-0.80	2100	28480	10



- 25 °C / + 70 °C
 - 13 °F / +158 °F

MARKING / BESCHRIFTUNG / MARCATURA / MARQUAGE: **TRANSFER TAPE OR EMBOSSED**



NORMS NORMEN NORME NORMLAR	ISO 1307	COLOUR FARBEN COLORI RENKLER	
-------------------------------------	----------	---------------------------------------	--



Water Suction & Discharge

CORRUGATED



TUBE : NATURAL AND SYNTHETIC RUBBER.
 REINFORCEMENT : HIGH TENSILE SYNTHETIC TEXTILE AND STEEL HELIX WIRE.
 COVER : WEATHER AND ABRASION RESISTANT SYNTHETIC RUBBER - CORRUGATED WITH CUFFED ENDS.
 APPLICATION : WATER SUCTION AND DELIVERY, IN AGRICULTURAL, INDUSTRIAL AND CONSTRUCTION APPLICATIONS.



SEELE : NATUR- UND SYNTHETISCHER KAUTSCHUK.
 EINLAGE : HOCHZUGFESTE SYNTHETISCHE EINLAGE MIT STAHLDRAHTEINLAGE.
 DECKE : WETTER- UND ABRIEBFESTER SYNTHETISCHER GUMMI, GEWELLT MIT SPIRALFREIEN MUFFEN.
 ANWENDUNG : SAUG & DRUCKSCHLAUCH ZUR VERWENDUNG IN INDUSTRIE, LANDWIRTSCHAFT UND BAUBRANCHE.



SOTTOSTRATO : GOMMA NATURALE E SINTETICA.
 RINFORZO : INSERZIONI TESSILI AD ALTA TENACITÀ E SPIRALE D'ACCIAIO INCORPARATA.
 COPERTURA : GOMMA SINTETICA RESISTENTE ALL'ABRASIONE ED AGLI AGENTI ATMOSFERICI ONDULATA CON MANICOTTI.
 IMPIEGO : ASPIRAZIONE E MANDATA D'ACQUA AD USO INDUSTRIALE, EDILIZIA E NEI POZZI NERI.



TUBE : CAOUTCHOUC NATUREL ET SYNTHETIQUE.
 RENFORCEMENT : INSERTION TEXTILE HAUTE TENACITE ET SPIRALE EN ACIER NOYEE.
 REVETEMENT : CAOUTCHOUC SYNTHETIQUE RESISTANT A L'ABRASION ET AUX AGENTS ATMOSPHERIQUES - ONDULE AVEC MANCHETTE SOUPLE.
 APPLICATION : POUR ASPIRATION ET REFOULEMENT D'EAU DANS L'INDUSTRIE, L'AGRICULTURE ET CONSTRUCTION.

ID		Cuffed End Length(cm)	WP		BP		VACUUM	BR/r	W	L
inch	mm		bar	psi	bar	psi	bar	mm	g/m	m
1"	25.4	10	3	44	10	145	-0.63	65	635	1-6
1 1/4"	32	12	3	44	10	145	-0.63	85	865	1-6
1 1/2"	38	12	3	44	10	145	-0.63	110	1090	1-6
1 3/4"	44.5	12	3	44	10	145	-0.63	125	1335	1-6
2"	50.8	12	3	44	10	145	-0.63	140	1402	1-6
2 1/2"	63.5	12	3	44	10	145	-0.63	200	2090	1-6
2 3/4"	70	12	3	44	10	145	-0.63	250	2425	1-6
3"	76.2	12	3	44	10	145	-0.63	275	2660	1-6
4"	101.6	12	3	44	10	145	-0.63	400	3540	1-6
5"	127	15	3	44	10	145	-0.63	500	5470	1-6
6"	152.4	15	3	44	10	145	-0.63	600	6965	1-6
8"	203.2	15	3	44	10	145	-0.63	800	9245	1-6
10"	254	15	3	44	10	145	-0.63	1100	15930	1-6
12"	304.8	15	3	44	10	145	-0.63	1400	18915	1-6

OPTIONS / OPTIONEN / OPZIONI / OPTIONS

Upon Request : ISO 4641 Type 1,2,3
 Auf Anfrage : ISO 4641 Type 1,2,3
 Su Richiesta : ISO 4641 Type 1,2,3
 Sur Demande : ISO 4641 Type 1,2,3



-25°C / + 70°C
 -13°F / +158°F

MARKING / BESCHRIFTUNG / MARCATURA / MARQUAGE: **TRANSFER TAPE OR EMBOSSED**





NORMS NORMEN NORME NORMES	ISO 1307	COLOUR FARBEN COLORI COULEUR	
------------------------------------	----------	---------------------------------------	--

Water Suction & Discharge

FLAT CORRUGATED



 TUBE : NATURAL AND SYNTHETIC RUBBER.
 REINFORCEMENT : HIGH TENSILE SYNTHETIC TEXTILE AND STEEL HELIX WIRE.
 COVER : WEATHER AND ABRASION RESISTANT SYNTHETIC RUBBER - FLAT CORRUGATED.
 APPLICATION : WATER SUCTION AND DELIVERY, IN AGRICULTURAL, INDUSTRIAL AND CONSTRUCTION APPLICATIONS.

 SEELE : NATUR- UND SYNTHETISCHER KAUTSCHUK.
 EINLAGE : HOCHZUGFESTE SYNTHETISCHE EINLAGE MIT STAHLDRAHTEINLAGE.
 DECKE : WETTER- UND ABRIEFESTER SYNTETHISCHER GUMMI, LEICHT GEWELLT.
 ANWENDUNG : SAUG & DRUCKSCHLAUCH ZUR VERWENDUNG IN INDUSTRIE, LANDWIRTSCHAFT UND BAUBRANCHE.

 SOTTOSTRATO : GOMMA NATURALE E SINTETICA.
 RINFORZO : INSERZIONI TESSILI AD ALTA TENACITÀ E SPIRALE D'ACCIAIO INCORPORATA.
 COPERTURA : GOMMA SINTETICA RESISTENTE ALL'ABRASIONE ED AGLI AGENTI ATMOSFERICI - ONDULATO PIATTO.
 IMPIEGO : ASPIRAZIONE E MANDATA D'ACQUA AD USO INDUSTRIALE, EDILIZIA E NEI POZZI NERI.

 TUBE : CAOUTCHOUC NATUREL ET SYNTHETIQUE.
 RENFORCEMENT : INSERTION TEXTILE HAUTE TENACITE ET SPIRALE EN ACIER NOYEE.
 REVETEMENT : CAOUTCHOUC SYNTHETIQUE RESISTANT A L'ABRASION ET AUX AGENTS ATMOSPHERIQUES, ONDULE PLAT.
 APPLICATION : POUR ASPIRATION ET REFOULEMENT D'EAU DANS L'INDUSTRIE, L'AGRICULTURE ET CONSTRUCTION.

ID		OD	WP		BP		VACUUM	BR/r	W	L
inch	mm	mm	bar	psi	bar	psi	bar	mm	g/m	m
3/4"	19	27	10	145	30	435	-0.92	50	440	40-46-61
1"	25.4	34	10	145	30	435	-0.92	65	605	40-46-61
1 1/4"	32	41	10	145	30	435	-0.92	80	805	40-46-61
1 1/2"	38	47	10	145	30	435	-0.92	100	915	40-46-61
2"	50.8	61	10	145	30	435	-0.92	140	1440	40-46-61
2 1/2"	63.5	74	10	145	30	435	-0.92	175	1780	40-46-61
3"	76.2	88	10	145	30	435	-0.92	250	2300	40-46-61
4"	101.6	115	10	145	30	435	-0.92	350	3740	40-46-61
5"	127	143	10	145	30	435	-0.80	440	5735	40-46-61
6"	152.4	169	10	145	30	435	-0.80	600	7395	40-46-61

 -25°C / + 70°C
 -13°F / +158°F

MARKING / BESCHRIFTUNG / MARCATURA / MARQUAGE: **TRANSFER TAPE OR EMBOSSED**

SEL ADRIATIC WATER S/D HOSE W.P. 10 Bar (145 PSI) 

NORMS NORMEN NORME NORMES	ISO 1307	COLOUR FARBEN COLORI COULEUR	
------------------------------------	----------	---------------------------------------	--

Water Suction & Discharge

CHANNELED



TUBE : NATURAL AND SYNTHETIC RUBBER.
 REINFORCEMENT : HIGH TENSILE SYNTHETIC TEXTILE AND STEEL HELIX WIRE.
 COVER : ABRASION AND WEATHER RESISTANT SYNTHETIC RUBBER - CHANNELED.
 APPLICATION : WATER SUCTION AND DISCHARGE IN INDUSTRIAL AND CONSTRUCTION APPLICATIONS.



SEELE : NATUR- UND SYNTHETISCHER KAUSCHUK.
 EINLAGE : HOCHZUGFESTE SYNTHETISCHE EINLAGE MIT STAHLDRAPTEINLAGE.
 DECKE : WETTER- UND ABRIEBFESTER SYNTHETISCHER GUMMI, KORDELGERIPPT.
 ANWENDUNG : SAUG & DRUCKSCHLAUCH ZUR VERWENDUNG IN INDUSTRIE UND BAUBRANCHE.



SOTTOSTRATO : GOMMA NATURALE E SINTETICA.
 RINFORZO : INSERZIONI TESSILI AD ALTA TENACITÀ E SPIRALE D'ACCIAIO INCORPORATA.
 COPERTURA : GOMMA SINTETICA RESISTENTE ALL'ABRASIONE ED AGLI AGENTI ATMOSFERICI - GRECATO.
 IMPIEGO : ASPIRAZIONE E MANDATA D'ACQUA AD USO INDUSTRIALE ED EDILIZIA.



TUBE : CAOUTCHOUC NATUREL ET SYNTHETIQUE.
 RENFORCEMENT : INSERTION TEXTILE HAUTE TENACITE ET SPIRALE EN ACIER NOYEE.
 REVETEMENT : CAOUTCHOUC SYNTHETIQUE RESISTANT A L'ABRASION ET AUX AGENTS ATMOSPHERIQUES, ASPECT CRENELE.
 APPLICATION : POUR ASPIRATION ET REFOULEMENT D'EAU DANS L'INDUSTRIE ET CONSTRUCTION.

ID		OD	WP		BP		VACUUM	BR/r	W	L
inch	mm	mm	bar	psi	bar	psi	bar	mm	g/m	m
3/4"	19	29	10	145	30	435	-0.92	40	505	40-46-61
1"	25.4	35	10	145	30	435	-0.92	50	695	40-46-61
1 1/4"	32	42	10	145	30	435	-0.92	65	890	40-46-61
1 1/2"	38	48	10	145	30	435	-0.92	85	1035	40-46-61
2"	50.8	62	10	145	30	435	-0.92	120	1445	40-46-61
2 1/2"	63.5	75	10	145	30	435	-0.92	160	1935	40-46-61
3"	76.2	90	8	116	24	348	-0.92	190	2610	40-46-61
4"	101.6	117	8	116	24	348	-0.92	280	3900	40-46-61
5"	127	146	8	116	24	348	-0.80	350	6400	40-46-61
6"	152.4	170	8	116	24	348	-0.80	550	7000	40-46-61



-25°C / + 70°C
 -13°F / +158°F

MARKING / BESCHRIFTUNG / MARCATURA / MARQUAGE: **TRANSFER TAPE OR EMBOSSED**

SEL VAN WATER S/D HOSE W.P. 10 Bar (145 PSI)

NORMS NORMEN NORME NORMES	ISO 1307	COLOUR FARBEN COLORI COULEUR	
------------------------------------	----------	---------------------------------------	--

Tank Cleaning Hose



TUBE : DETERGENT RESISTANT EPDM RUBBER.
 REINFORCEMENT : HIGH TENSILE SYNTHETIC TEXTILE AND 2 ANTISTATIC COPPER WIRE.
 COVER : WEATHER AND DETERGENT RESISTANT EPDM RUBBER.
 APPLICATION : FOR TANK CLEANING APPLICATIONS.



SEELE : SPÜLMITTELBESTÄNDIGER EPDM GUMMI.
 EINLAGE : HOCHZUGFESTES; SYNTHETISCHES TEXTILGEFLECHT UND 2 ANTISTATISCHE KUPFERLITZEN.
 DECKE : WETTER UND SPÜLMITTEL BESTÄNDIGER EPDM GUMMI.
 ANWENDUNG : FÜR REINIGUNG VON BEHÄLTERN UND TANKS.



SOTTOSTRATO : GOMMA IN EPDM RESISTENTE AI DETERSIVI.
 RINFORZO : INSERZIONI TESSILI AD ALTA TENACITÀ E 2 CORDICELLE DI RAME ANTISTATICA.
 COPERTURA : GOMMA IN EPDM RESISTENTE AI DETERSIVI ED AGLI AGENTI ATMOSFERICI.
 IMPIEGO : PER LA PULIZIA DEI SERBATOI.



TUBE : CAOUTCHOUC EPDM RESISTANT AUX DETERGENTS.
 RENFORCEMENT : INSERTION TEXTILE HAUTE TENACITE ET 2 FILS DE MASSE ANTISTATIQUE.
 REVETEMENT : CAOUTCHOUC EPDM RESISTANT AUX AGENTS ATMOSPHERIQUES ET AUX DETERGENTS.
 APPLICATION : POUR NETTOYAGE DE RESERVOIRS.

ID		OD	WP		BP		W	L
inch	mm	mm	bar	psi	bar	psi	g/m	m
1 1/2"	38	54	25	363	75	1088	1630	40-46-61
2"	50.8	68	25	363	75	1088	2291	40-46-61



-40°C / +125°C
 -40°F / +257°F

MARKING / BESCHRIFTUNG / MARCATURA / MARQUAGE: **TRANSFER TAPE OR EMBOSSED**



NORMS NORMEN NORME NORMES	ISO 1307	COLOUR FARBEN COLORI COULEUR	
------------------------------------	----------	---------------------------------------	--

Artificial Snow

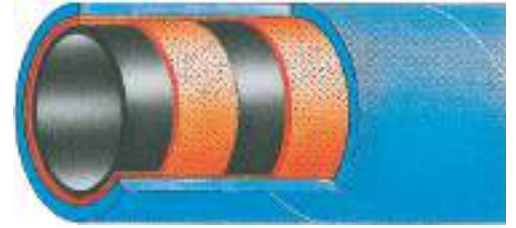

TUBE : SBR/NBR RUBBER.
 REINFORCEMENT : HIGH TENSILE SYNTHETIC TEXTILE.
 COVER : ABRASION, OZONE, WEATHER RESISTANT SBR-EPDM RUBBER.
 APPLICATION : FOR ARTIFICIAL SNOW EQUIPMENTS.



SEELE : SBR / NBR GUMMI.
 EINLAGE : HOCHZUGFESTE SYNTHETISCHE TEXTILEINLAGE.
 DECKE : ABRIEBFESTER, OZON- UND WETTERBESTÄNDIGER SBR-EPDM GUMMI.
 ANWENDUNG : FÜR SCHNEEKANONEN / SCHNEEERZEUGER.



SOTTOSTRATO : GOMMA SBR/NBR.
 RINFORZO : INSERZIONI TESSILI AD ALTA TENACITÀ.
 COPERTURA : GOMMA SBR-EPDM RESISTENTE ALL'ABRASIONE, ALL'OZONO ED AGLI AGENTI ATMOSFERICI.
 IMPIEGO : IMPIANTI DI INNEVAMENTO ARTIFICIALE.



TUBE : CAOUTCHOUC SBR/NBR.
 RENFORCEMENT : INSERTION TEXTILE HAUTE TENACITE.
 REVETEMENT : CAOUTCHOUC SBR/EPDM RESISTANT A L'ABRASION, A L'OZONE ET AUX AGENTS ATMOSPHERIQUES.
 APPLICATION : POUR CANONS A NEIGE.

ID		OD	WP		BP		W	L
inch	mm	mm	bar	psi	bar	psi	g/m	m
1 1/2"	38	52	40	580	160	2320	1340	40-46-61
2"	50.8	67	40	580	160	2320	1980	40-46-61



-40°C / + 70°C
 -40°F / +158°F

MARKING / BESCHRIFTUNG / MARCATURA / MARQUAGE: **TRANSFER TAPE OR EMBOSSED**



NORMS NORMEN NORME NORMES	ISO 1307	COLOUR FARBEN COLORI COULEUR	
------------------------------------	----------	---------------------------------------	--

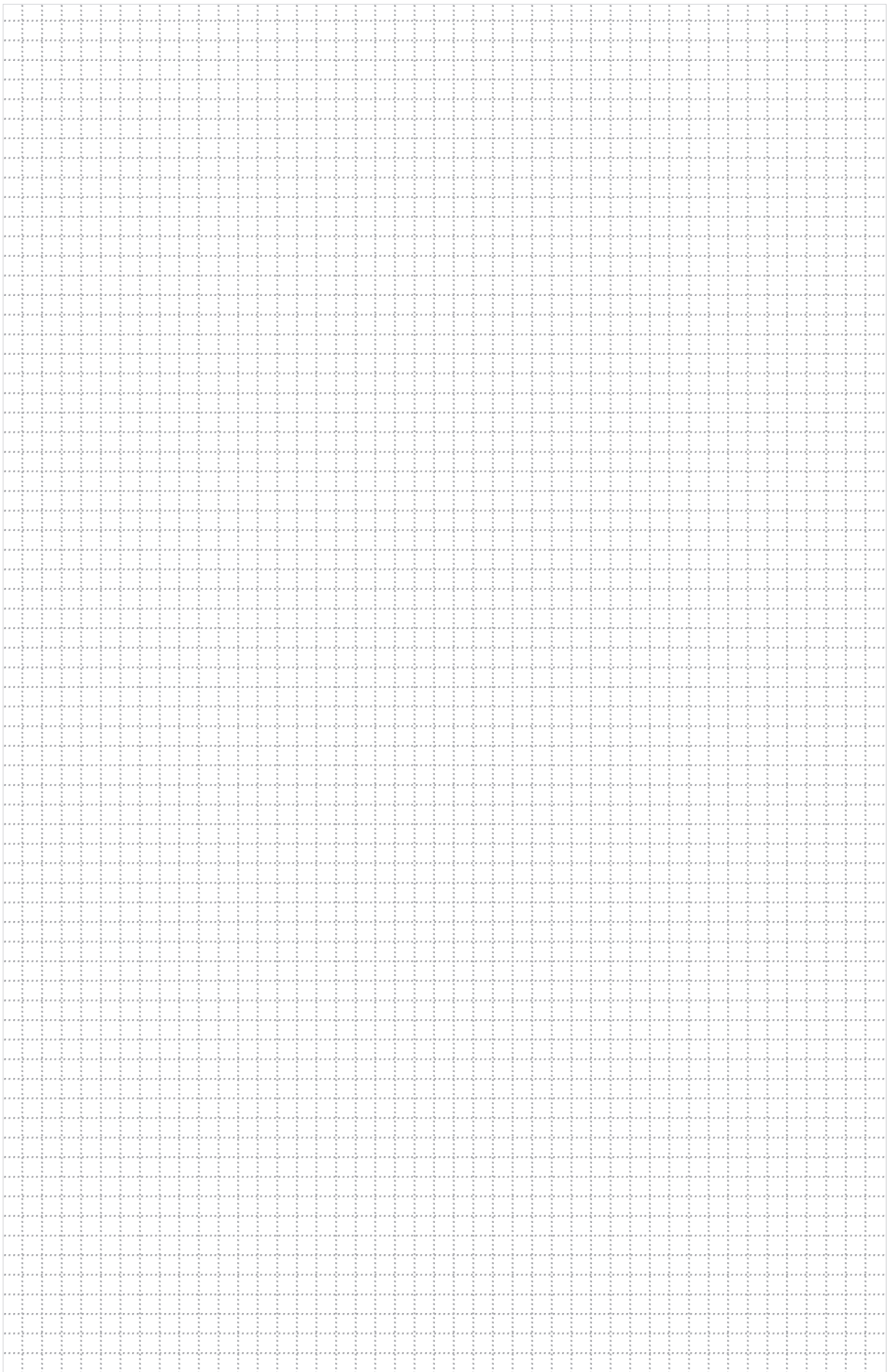

Sewer & Road Cleaning

Kanal- und Straßenreinigung

Lavaggio Fognatura & Strada

Hydrocurage & Route



Sewer Jetting

200 BAR



TUBE : SPECIAL SYNTHETIC RUBBER.
 REINFORCEMENT : HIGH TENSILE SYNTHETIC TEXTILE.
 COVER : ABRASION, OIL AND WEATHER RESISTANT SMOOTH, SPECIAL SYNTHETIC RUBBER.
 APPLICATION : FOR HIGH PRESSURE WATER CLEANING AND RINSING OF SEWAGE SYSTEMS.



SEELE : SPEZIELLER SYNTHETISCHER GUMMI.
 EINLAGE : HOCHZUGFESTE SYNTHETISCHE TEXTILGEFLECHTE.
 DECKE : SPEZIELLER SYNTHETISCHER GUMMI, ABRIEBFEST, GLATT, ÖL- UND WETTERBESTÄNDIG.
 ANWENDUNG : FÜR HOCHDRUCKANWENDUNGEN MIT WASSER UND KANALREINIGUNG.



SOTTOSTRATO : GOMMA SPECIALE SINTETICA.
 RINFORZO : INSERZIONI TESSILI AD ALTA TENACITÀ.
 COPERTURA : GOMMA SPECIALE SINTETICA, LISCIA, RESISTENTE ALL'ABRASIONE, OLII ED AGLI AGENTI ATMOSFERICI.
 IMPIEGO : PER PULIZIE AD ALTA PRESSIONE DELLE FOGNATURE IN CONDIZIONI D'IMPIEGO GRAVOSE.



TUBE : CAOUTCHOUC SPECIAL SYNTHETIQUE.
 RENFORCEMENT : INSERTION TEXTILE HAUTE TENACITE.
 REVETEMENT : CAOUTCHOUC SPECIAL SYNTHETIQUE, RESISTANT A L'ABRASION, AUX HUILES ET AUX AGENTS ATMOSPHERIQUES.
 APPLICATION : POUR NETTOYAGE DES EGOUTS ET NETTOYAGE INTENSIF A L'EAU SOUS PRESSION ELEVEE.

ID		OD		WP		BP		BR/r	W	L
inch	mm	mm	mm	bar	psi	bar	psi	mm	g/m	m
1/2"	12.7	25	200	2900	500	7250	65	430	Max. 240	
5/8"	16	28	200	2900	500	7250	80	450	Max. 240	
3/4"	19	31.6	200	2900	500	7250	90	545	Max. 240	
1"	25.4	39.3	200	2900	500	7250	105	770	Max. 240	
1 1/4"	31.8	48	200	2900	500	7250	140	1040	Max. 200	
1 1/2"	38.1	54	200	2900	500	7250	150	1230	Max. 200	

OPTIONS / OPTIONEN / OPZIONI / OPTIONS

- Upon Request : Could be assembled with BSP female / male couplings.
 Auf Anfrage : Kann angewendet werden als BSP Temperierkupplungs-Muffe mit Ventil/BSP Steckkupplung.
 Su Richiesta : Potrebbe essere assemblato con raccordi BSP maschio / femmina.
 Sur Demande : Peuvent etre equipés de raccords mâles / femelles BSP.



-40°C / + 70°C
 -40°F / +158°F

MARKING / BESCHRIFTUNG / MARCATURA / MARQUAGE: **TRANSFER TAPE - EMBOSSED OR INK-JET**

SEL TB KUKA 200 SEWER JETTING HOSE ** (DN ** mm) W.P. 200 Bar (2900 PSI)

NORMS NORMEN NORME NORMES	ISO 1307	COLOUR FARBEN COLORI COULEUR	
------------------------------------	----------	---------------------------------------	--





Sewer Jetting

200 BAR



 TUBE : SPECIAL PE COMPOUND.
 REINFORCEMENT : HIGH TENSILE SYNTHETIC TEXTILE.
 COVER : ABRASION AND WEATHER RESISTANT TPU COMPOUND.
 APPLICATION : FOR HIGH PRESSURE WATER CLEANING AND RINSING OF SEWAGE SYSTEMS

 SEELE : SPEZIELLE PE - MISCHUNG.
 EINLAGE : HOCHZUGFESTE SYNTHETISCHE TEXTILGEFLECHTE.
 DECKE : ABRIEBFESTE UND WETTERBESTÄNDIGE TPU - MISCHUNG.
 ANWENDUNG : FÜR HOCHDRUCKANWENDUNGEN MIT WASSER UND KANALREINIGUNG.

 SOTTOSTRATO : MESCOLA SPECIALE IN PE.
 RINFORZO : INSERZIONI TESSILI AD ALTA TENACITÀ.
 COPERTURA : MESCOLA SPECIALE IN TPU, RESISTENTE ALL'ABRASIONE ED AGLI AGENTI ATMOSFERICI.
 IMPIEGO : PER PULIZIA AD ALTA PRESSIONE DELLE FOGNATURE IN CONDIZIONI D'IMPIEGO GRAVOSE.

 TUBE : MELANGE SPECIAL EN PE.
 REINFORCEMENT : INSERTION TEXTILE HAUTE TENACITE.
 REVETEMENT : MELANGE EN TPU RESISTANT A L'ABRASION ET AUX AGENTS ATMOSPHERIQUES.
 APPLICATION : POUR NETTOYAGE DES EGOUTS ET NETTOYAGE INTENSIF A L'EAU SOUS PRESSION ELEVEE.

ID		OD		WP		BP		BR/r	W	L
inch	mm	mm	bar	psi	bar	psi	mm	g/m	m	
1/2"	12.7	20.6	200	2900	500	7250	100	230	Max. 400	
3/4"	19.2	29.6	200	2900	500	7250	220	425	Max. 350	
1"	25.4	38	200	2900	500	7250	300	610	Max. 250	
1 1/4"	32	48.5	200	2900	500	7250	350	1140	Max. 200	

OPTIONS / OPTIONEN / OPZIONI / OPTIONS

Upon Request : Could be assembled with BSP female / male couplings.
 Auf Anfrage : Kann angewendet werden als BSP Temperierkupplungs-Muffe mit Ventil/BSP Steckkupplung.
 Su Richiesta : Potrebbe essere assemblato con raccordi BSP maschio / femmina.
 Sur Demande : Peuvent etre equipés de raccords mâles / femelles BSP.



-20°C / + 60°C
 - 4°F / +140°F

MARKING / BESCHRIFTUNG / MARCATURA / MARQUAGE: **INK-JET**

SEL TPU KUKA - 200 SEWER JETTING HOSE **" (DN ** mm) W.P. 200 Bar (2900 PSI)



NORMS
 NORMEN
 NORME
 NORMES

ISO 1307

COLOUR
 FARBEN
 COLORI
 COULEUR



Sewer Jetting

250 BAR



TUBE : SPECIAL SYNTHETIC RUBBER.
 REINFORCEMENT : HIGH TENSILE SYNTHETIC TEXTILE.
 COVER : ABRASION, OIL AND WEATHER RESISTANT SMOOTH, SPECIAL SYNTHETIC RUBBER.
 APPLICATION : FOR HIGH PRESSURE WATER CLEANING AND RINSING OF SEWAGE SYSTEMS.



SEELE : SPEZIELLER SYNTHETISCHER GUMMI.
 EINLAGE : HOCHZUGFESTE SYNTHETISCHE TEXTILGEFLECHTE.
 DECKE : SPEZIELLER SYNTHETISCHER GUMMI, ABRIEBFEST, GLATT, ÖL- UND WETTERBESTÄNDIG.
 ANWENDUNG : FÜR HOCHDRUCKANWENDUNGEN MIT WASSER UND KANALREINIGUNG.



SOTTOSTRATO : GOMMA SPECIALE SINTETICA.
 RINFORZO : INSERZIONI TESSILI AD ALTA TENACITÀ.
 COPERTURA : GOMMA SPECIALE SINTETICA, LISCIA, RESISTENTE ALL'ABRASIONE, OLII ED AGLI AGENTI ATMOSFERICI.
 IMPIEGO : PER PULIZIE AD ALTA PRESSIONE DELLE FOGNATURE IN CONDIZIONI D'IMPIEGO GRAVOSE.



TUBE : CAOUTCHOUC SPECIAL SYNTHETIQUE.
 REINFORCEMENT : INSERTION TEXTILE HAUTE TENACITE.
 REVETEMENT : CAOUTCHOUC SPECIAL SYNTHETIQUE, RESISTANT A L'ABRASION, AUX HUILES ET AUX AGENTS ATMOSPHERIQUES.
 APPLICATION : POUR NETTOYAGE DES EGOUTS ET NETTOYAGE INTENSIF A L'EAU SOUS PRESSION ELEVEE.

ID		OD		WP		BP		BR/r	W	L
inch	mm	mm	mm	bar	psi	bar	psi	mm	g/m	m
1/2"	12.7	25	250	3625	625	9063	65	440	Max. 240	
5/8"	16	28	250	3625	625	9063	75	480	Max. 240	
3/4"	19	31.6	250	3625	625	9063	90	555	Max. 240	
1"	25.4	39.3	250	3625	625	9063	100	780	Max. 240	
1 1/4"	31.8	48	250	3625	625	9063	130	1060	Max. 200	
1 1/2"	38.1	54	250	3625	625	9063	150	1250	Max. 200	

OPTIONS / OPTIONEN / OPZIONI / OPTIONS

Upon Request : Could be assembled with BSP female / male couplings.
 Auf Anfrage : Kann angewendet werden als BSP Temperierkupplungs-Muffe mit Ventil/BSP Steckkupplung.
 Su Richiesta : Potrebbe essere assemblato con raccordi BSP maschio / femmina.
 Sur Demande : Peuvent etre equipés de raccords mâles / femelles BSP.



-40°C / + 70°C
 -40°F / +158°F

MARKING / BESCHRIFTUNG / MARCATURA / MARQUAGE: **TRANSFER TAPE - EMBOSSED OR INK-JET**

SEL TB KUKA 250 SEWER JETTING HOSE ** (DN ** mm) W.P. 250 Bar (3625 PSI)

NORMS NORMEN NORME NORMES	ISO 1307	COLOUR FARBEN COLORI COULEUR	
------------------------------------	----------	---------------------------------------	--





Sewer Jetting

250 BAR



 TUBE : SPECIAL PE COMPOUND.
 REINFORCEMENT : HIGH TENSILE SYNTHETIC TEXTILE.
 COVER : ABRASION AND WEATHER RESISTANT TPU COMPOUND.
 APPLICATION : FOR HIGH PRESSURE WATER CLEANING AND RINSING OF SEWAGE SYSTEMS.

 SEELE : SPEZIELLE PE - MISCHUNG .
 EINLAGE : HOCHZUGFESTE SYNTHETISCHE TEXTILGEFLECHTE.
 DECKE : ABRIEBFESTE UND WETTERBESTÄNDIGE TPU - MISCHUNG.
 ANWENDUNG : FÜR HOCHDRUCKANWENDUNGEN MIT WASSER UND KANALREINIGUNG.

 SOTTOSTRATO : MESCOLA SPECIALE IN PE
 RINFORZO : INSERZIONI TESSILI AD ALTA TENACITÀ
 COPERTURA : MESCOLA SPECIALE IN TPU, RESISTENTE ALL'ABRASIONE ED AGLI AGENTI ATMOSFERICI
 IMPIEGO : PER PULIZIA AD ALTA PRESSIONE DELLE FOGNATURE IN CONDIZIONI D'IMPIEGO GRAVOSE.

 TUBE : MELANGE SPECIAL EN PE.
 RENFORCEMENT : INSERTION TEXTILE HAUTE TENACITE.
 REVETEMENT : MELANGE EN TPU RESISTANT A L'ABRASION ET AUX AGENTS ATMOSPHERIQUES.
 APPLICATION : POUR NETTOYAGE DES EGOUTS ET NETTOYAGE INTENSIF A L'EAU SOUS PRESSION ELEVEE.

ID		OD		WP		BP		BR/r	W	L
inch	mm	mm	bar	psi	bar	psi	mm	g/m	m	
1/2"	12.7	20.6	250	3625	625	9063	100	200	Max. 400	
3/4"	19.2	28.6	250	3625	625	9063	220	400	Max. 350	
1"	25.4	37.2	250	3625	625	9063	300	630	Max. 250	
1 1/4"	32	46.5	250	3625	625	9063	350	925	Max. 200	

OPTIONS / OPTIONEN / OPZIONI / OPTIONS

Upon Request : Could be assembled with BSP female / male couplings.
 Auf Anfrage : Kann angewendet werden als BSP Temperierkupplungs-Muffe mit Ventil/BSP Steckkupplung.
 Su Richiesta : Potrebbe essere assemblato con raccordi BSP maschio / femmina.
 Sur Demande : Peuvent etre equipés ole raccords mâles / femelles BSP.



-20°C / + 60°C
 - 4°F / +140°F

MARKING / BESCHRIFTUNG / MARCATURA / MARQUAGE: **INK-JET**

SEL TPU KUKA - 250 SEWER JETTING HOSE ** (DN ** mm) W.P. 250 Bar (3625 PSI)



NORMS
 NORMEN
 NORME
 NORMES

ISO 1307

COLOUR
 FARBEN
 COLORI
 COULEUR



Sewer Jetting



TUBE : SPECIAL SYNTHETIC RUBBER.
 REINFORCEMENT : 1 HIGH TENSILE STEEL WIRE BRAID.
 COVER : ABRASION, OIL AND WEATHER RESISTANT SMOOTH, SPECIAL SYNTHETIC RUBBER.
 APPLICATION : FOR HIGH PRESSURE WATER CLEANING AND RINSING OF SEWAGE SYSTEMS.



SEELE : SPEZIELLER SYNTHETISCHER GUMMI.
 EINLAGE : 1 GEFLECHTSEINLAGE AUS HOCHZUGFESTEM STAHLDRAHT.
 DECKE : SPEZIELLER SYNTHETISCHER GUMMI, ABRIEBFEST, GLATT, ÖL- UND WETTERBESTÄNDIG.
 ANWENDUNG : FÜR HOCHDRUCKANWENDUNGEN MIT WASSER UND KANALREINIGUNG.



SOTTOSTRATO : GOMMA SPECIALE SINTETICA.
 RINFORZO : 1 TRECCIA IN ACCIAIO AD ALTA TENACITÀ.
 COPERTURA : GOMMA SPECIALE SINTETICA, LISCIA, RESISTENTE ALL'ABRASIONE, OLII ED AGLI AGENTI ATMOSFERICI.
 IMPIEGO : PER PULIZIE AD ALTA PRESSIONE DELLE FOGNATURE IN CONDIZIONI D'IMPIEGO GRAVOSE.



TUBE : CAOUTCHOUC SPECIAL SYNTHETIQUE.
 REINFORCEMENT : 1 TRESSE D'ACIER TRES RESISTANTE.
 REVETEMENT : CAOUTCHOUC SPECIAL SYNTHETIQUE, RESISTANT A L'ABRASION, AUX HUILES ET AUX AGENTS ATMOSPHERIQUES.
 APPLICATION : POUR NETTOYAGE DES EGOUTS ET NETTOYAGE INTENSIF A L'EAU SOUS PRESSION ELEVEE.

ID		OD		WP		BP		BR/r	W	L
inch	mm	mm	bar	psi	bar	psi	mm	g/m	m	
1/2"	12.7	20.7	250	3625	625	9063	50	420	max. 240	
5/8"	16	23.8	250	3625	625	9063	75	485	max. 240	

OPTIONS / OPTIONEN / OPZIONI / OPTIONS

- Upon Request : Could be assembled with BSP female / male couplings.
 Auf Anfrage : Kann angewendet werden als BSP Temperierkupplungs-Muffe mit Ventil/BSP Steckkupplung.
 Su Richiesta : Potrebbe essere assemblato con raccordi BSP maschio / femmina.
 Sur Demande : Peuvent etre equipés de raccords mâles / femelles BSP.



-40°C / + 70°C
 -40°F / +158°F

MARKING / BESCHRIFTUNG / MARCATURA / MARQUAGE: **TRANSFER TAPE - EMBOSSED OR INK-JET**

SEL SWB KUKA 250 SEWER JETTING HOSE ** (DN ** mm) W.P. 250 Bar (3625 PSI)

NORMS NORMEN NORME NORMES	ISO 1307	COLOUR FARBEN COLORI COULEUR	
------------------------------------	----------	---------------------------------------	--



Inserts

TYPE AGR		BSP PARALLEL MALE - 60° CONE SEAT					
SEL Part No	Hose I.D. Ø			Thread	Dimensions(mm)		
	DN	Size	Inch	F	H	L	S
RKIS3030101200003	12	08	1/2"	1/2"-14	18,5	75	27
RKIS3030101600006	16	10	5/8"	1/2"-14	18,5	75	27
RKIS3030101600007	16	10	5/8"	5/8"-14	18,5	75	30
RKIS3030101900007	19	12	3/4"	3/4"-14	32,5	86,5	32
RKIS3030101900010	19	12	3/4"	1"-11	34	90,5	41
RKIS3030102500011	25	16	1"	1" - 11	34	101	41
RKIS3030103100015	32	20	1 1/4"	1 1/4"-11	38,5	113	50
RKIS3030103800018	38	24	1 1/2"	1 1/2"-11	40	114	55

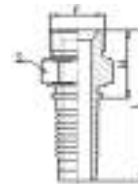

- TB KUKA - 200
- TB KUKA - 250
- TPU KUKA - 200
- TPU KUKA - 250
- SWB KUKA 200
- SWB KUKA 250

TYPE AGR-K		BSP TAPER MALE - 60° CONE SEAT					
SEL Part No	Hose I.D. Ø			Thread	Dimensions(mm)		
	DN	Size	Inch	F	H	L	S
RKIS3030201200002	12	08	1/2"	1/2"-14	28,5	75	22
RKIS3030201600001	16	10	5/8"	1/2"-14	28,5	75	22
RKIS3030201600002	16	10	5/8"	3/4"-14	28,5	75	27
RKIS3030201900004	19	12	3/4"	3/4"-14	33,5	86,5	27
RKIS3030202500006	25	16	1"	1" - 11	40	105	36
RKIS3030203100008	32	20	1 1/4"	1 1/4"-11	49,5	123,5	46
RKIS3030203800011	38	24	1 1/2"	1 1/2"-11	49	130	50

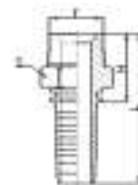

- TB KUKA - 200
- TB KUKA - 250
- TPU KUKA - 200
- TPU KUKA - 250
- SWB KUKA 200
- SWB KUKA 250

TYPE DKR		BSP STRAIGHT FEMALE - 60° CONE SEAT					
SEL Part No	Hose I.D. Ø			Thread	Dimensions(mm)		
	DN	Size	Inch	F	H	L	S
RKIS3030501200006	12	08	1/2"	1/2"-14	22,5	69,5	25
RKIS3030501600013	16	10	5/8"	1/2"-14	22,5	72	25
RKIS3030501600012	16	10	5/8"	3/4"-14	19,5	72,7	32
RKIS3030501900016	19	12	3/4"	3/4"-14	33,5	86,5	27
RKIS3030501900020	19	12	3/4"	1"-11	22,5	75,5	41
RKIS3030502500022	25	16	1"	1" - 11	22,5	87	41
RKIS3030503100027	32	20	1 1/4"	1 1/4"-11	26,5	99	50
RKIS3030503800032	38	24	1 1/2"	1 1/2"-11	39,5	104	55

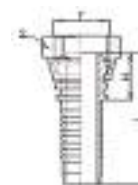

- TB KUKA - 200
- TB KUKA - 250
- TPU KUKA - 200
- TPU KUKA - 250
- SWB KUKA 200
- SWB KUKA 250

Ferrules

NO SKIVE		SWAGED NON SKIVE FERRULE			
SEL Part No	Hose I.D. Ø			Dimensions(mm)	
	DN	Size	Inch	D	L
RKFR1200001200008	12	08	1/2"	31	40
RKFR1200001600007	16	10	5/8"	32,5	44
RKFR1200001900005	19	12	3/4"	38,5	50
RKFR1200001900006	19	12	3/4"	43	50
RKFR1200002500008	25	16	1"	47	60
RKFR1200003100004	32	20	1 1/4"	58	70
RKFR1200003800005	38	24	1 1/2"	64	70

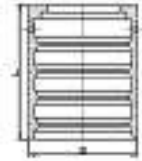

- TB KUKA - 200
- TB KUKA - 250

NO SKIVE		SWAGED NON SKIVE FERRULE			
SEL Part No	Hose I.D. Ø			Dimensions(mm)	
	DN	Size	Inch	D	L
RKFR1200001200011	12	08	1/2"	28	40
RKFR1200001600009	16	10	5/8"	32,5	44



- SWB KUKA - 200
- SWB KUKA - 250

NO SKIVE		SWAGED NON SKIVE FERRULE			
SEL Part No	Hose I.D. Ø			Dimensions(mm)	
	DN	Size	Inch	D	L
RKFR1200001200017	12	08	1/2"	30	40
RKFR1200001900010	19	12	3/4"	37	50
RKFR1200002500012	25	16	1"	46	60
RKFR1200003100007	32	20	1 1/4"	56	70

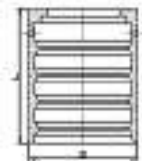

- TPU KUKA - 200
- TPU KUKA - 250

Sweeper Hose



TUBE : ABRASION RESISTANT NATURAL RUBBER.
 REINFORCEMENT : SPECIAL SYNTHETIC TEXTILE.
 COVER : ABRASION, OZONE AND WEATHER RESISTANT SPECIAL SYNTHETIC RUBBER.
 APPLICATION : USED ON STREET CLEANING MACHINES. EXTREMELY FLEXIBLE.



SEELE : HOCH ABRIEBFEST, NATURGUMMI.
 EINLAGE : HOCHZUGFESTE SYNTHETISCHE TEXTILEINLAGE.
 DECKE : OZON- UND WITTERUNGSBESTÄNDIGER, ABRIEBSFESTER, SPEZIELLER SYNTHETISCHER GUMMI.
 ANWENDUNG : FLEXIBLER SCHLAUCH FÜR DEN EINSATZ AUF STRASSENREINIGUNGSFAHRZEUGEN.



SOTTOSTRATO : GOMMA NATURALE RESISTENTE ALL'ABRASIONE.
 RINFORZO : INSERZIONI TESSILI.
 COPERTURA : GOMMA SPECIALE SINTETICA, RESISTENTE ALL'ABRASIONE, ALL'OZONO ED AGLI AGENTI ATMOSFERICI.
 IMPIEGO : UTILIZZATI SULLE MACCHINE PER LA PULIZIA STRADALE. MOLTO FLESSIBILE.



TUBE : CAOUTCHOUC NATUREL, RESISTANT A L'ABRASION.
 RENFORCEMENT : INSERTION TEXTILE SPECIALE.
 REVETEMENT : CAOUTCHOUC SYNTHETIQUE SPECIAL, RESISTANT A L'ABRASION, A L'OZONE ET AUX AGENTS ATMOSPHERIQUES.
 APPLICATION : POUR NETTOYAGE DES RUES PAR LES BALAYEUSES ASPIRATRICES, EXTREMEMENT FLEXIBLE.

ID		BR/r	W	L
inch	mm	mm	g/m	m
6"	152.4	150	3400	1 - 3
	180	180	3500	1 - 3
8"	203	200	4300	1 - 3
	219	220	5100	1 - 3
10"	254	250	5900	1 - 3
	273	270	6500	1 - 3
12"	304.8	300	7000	1 - 3
14"	355.6	350	10000	1 - 3

Notes on Ordering : Clarify length of the hose & couplings.
 Bemerkungen zum Auftrag : Die Länge des Schlauches und der Muffen muss angegeben werden.
 Note Ordini : Specificare la lunghezza del tubo e del manicotto.
 Precisions Necessaires : Preciser la longueur du tuyau et de la manchette.



-25°C / + 70°C
 -13°F / +158°F

MARKING / BESCHRIFTUNG / MARCATURA / MARQUAGE: **TRANSFER TAPE OR EMBOSSED**



NORMS NORMEN NORME NORMES	ISO 1307	COLOUR FARBEN COLORI COULEUR	
------------------------------------	----------	---------------------------------------	--

Vacuum Truck Hose



TUBE : OIL AND ABRASION RESISTANT BLACK ANTISTATIC NBR.
 REINFORCEMENT : HIGH TENSILE SYNTHETIC TEXTILE AND STEEL HELIX WIRE.
 COVER : OIL, ABRASION, OZONE AND WEATHER RESISTANT ANTISTATIC CR WITH CUFFED ENDS.
 APPLICATION : FOR SUCTION AND CLEANING OF SEWAGE SYSTEMS.



SEELE : ÖL- UND ABRIEBFESTER, SCHWARZER ANTISTATISCHER NBR.
 EINLAGE : HOCHZUGFESTE SYNTHETISCHE ANTISTATISCHE EINLAGE MIT STAHLDRAHTEINLAGE.
 DECKE : ABRIEB-, ÖL-, OZON- UND WITTERUNGBESTÄNDIGER CR GUMMI MIT MUFFEN.
 ANWENDUNG : SAUGSCHLAUCH GEEIGNET FÜR KANALREINIGUNG.



SOTTOSTRATO : GOMMA ANTISTATICA NBR, NERA, RESISTENTE AGLI OLI E ALL'ABRASIONE.
 RINFORZO : INSERZIONI TESSILI AD ALTA TENACITÀ E SPIRALE D'ACCIAIO INCORPORATA.
 COPERTURA : GOMMA ANTISTATICA IN CR, ONDULATA CON MANICOTTI, RESISTENTE ALL'ABRASIONE, AGLI OLI, A L'OZONO ED AGLI AGENTI ATMOSFERICI.
 IMPIEGO : PER ASPIRAZIONE E PULIZIA DI ACQUA, NELL'INDUSTRIA, NEI POZZI NERI E FOGNATURE.



TUBE : CAOUTCHOUC CONDUCTEUR NBR, NOIR, RESISTANT AUX HUILES ET A L'ABRASION.
 RENFORCEMENT : INSERTION TEXTILE HAUTE TENACITE ET SPIRALE EN ACIER NOYEE.
 REVETEMENT : CAOUTCHOUC CONDUCTEUR CR, ONDULE AVEC MANCHETTE SOUPLE, RESISTANT A L'ABRASION, A L'OZONE, AUX HUILES ET AUX AGENTS ATMOSPHERIQUES.
 APPLICATION : POUR ASPIRATION ET NETTOYAGE DES EGOUTS.

ID		OD		Cuffed End Length(cm)		WP		BP		VACUUM	BR/r	W	L
inch	mm	mm	mm	bar	psi	bar	psi	bar	mm	g/m	m		
4"	101.6	117	120	6	87	15	217	-0.92	300	4725	20		
5"	127	146	150	6	87	15	217	-0.92	350	6950	20		
6"	152.4	170	150	6	87	15	217	-0.92	400	8925	20		



-35°C / +100°C
 -31°F / +212°F

MARKING / BESCHRIFTUNG / MARCATURA / MARQUAGE: **TRANSFER TAPE OR EMBOSSED**



NORMS NORMEN NORME NORMES	ISO 1307	COLOUR FARBEN COLORI COULEUR	
------------------------------------	----------	---------------------------------------	--



Superelastic Medium Duty Suction&Delivery



CORRUGATED EXTERNAL HELIX (-30 °C)



CONSTRUCTION : STRONG, FLEXIBLE AND SMOOTH SPECIAL SUPERELASTIC MATERIAL.
SHOCK RESISTANT PVC SPIRAL.

APPLICATION : CRUSHING, CHEMICAL AGENTS, ABRASION AND WEATHER RESISTANT, CORRUGATED SLIDING OUTSIDE.
FOR MEDIUM DUTY SUCTION AND DELIVERY OF WATER, SALT WATER, LIGHT CHEMICALS, LIQUIDS ETC. IN AGRICULTURAL, INDUSTRIAL APPLICATIONS CONSTRUCTIONS, SEWER PURGING, SLUDGE, SLURRIES, WASTE MATTER, SAND AND GRAVEL, ETC. ESPECIALLY FOR USE IN VERY COLD CLIMATES.



KONSTRUKTION : STABILER, HOCHFLEXIBLER, GLATTER, KÄLTERESISTENTER, SUPER ELASTISCHER, PLASTIFIZIERTER PVC.
MIT VERSTÄRKUNGSSPIRALE AUS SCHLAG-UND DRUCKFESTEM PVC.

ANWENDUNG : ÄUSSERST STRAPAZIERFÄHIG UND BIEGSAM, DRUCK-UND ABRIEBFEST, WITTERUNGS-UND CHEMIKALIENBESTÄNDIG, GEWELLTE GLEITEND AUSSENDECKE.
FÜR LEICHTE ANWENDUNGEN ZUR BE-UND ENTLADEN VON WASSER, SALZWASSER, LEICHTE CHEMIKALIEN, ABRASIVEN MEDIEN USW; FÜR LANDWIRTSCHAFT, INDUSTRIEN, BAUWERKE, IM HAUSHALT UND IN KANALISATIONEN, SPEZIELL ZUR VERWENDUNG IN EXTREM KALTEN GEBIETEN.



COSTRUZIONE : TUBO LISCIO, LEGGERO E FLESSIBILE IN MATERIALE SPECIALE SUPERELASTICO.
SPIRALE DI RINFORZO IN PVC RIGIDO ANTI URTO E ANTISCHIACCIAMENTO.

IMPIEGO : ESTERNA ONDULATA, SCORREVOLE, RESISTENTE A CARICHI, ABRASIONE E AGENTI ATMOSFERICI ED A VARI PRODOTTI CHIMICI.
PER IMPIEGO MEDIO DI ASPIRAZIONE E MANDATA DI ACQUE, PRODOTTI CHIMICI LEGGERI, LIQUIDI A USO DOMESTICO, EDILIZIA, INDUSTRIA SPURGHI, AGRICOLTURA, SOLIDI ABRASIVI, SPECIALMENTE PER USO NEI CLIMI MOLTO FREDDI.



CONSTRUCTION : TUYAU LISSE ET FLEXIBLE EN MATIERE SPECIALE SUPERELASTIC.
SPIRE EN PVC RIGIDE ANTICHOC.

APPLICATION : SURFACE ONDULEE, GLISSANTE, RESISTANTE A L'ABRASION, LES AGENTS ATMOSPHERIQUES, ECRASEMENT ET LA PLUPART DES PRODUITS CHIMIQUES.
ASPIRATION ET REFOULEMENT D'EAU PURE, SALEE, CHARGEE DES SOLUTIONS CHIMIQUES LEGERES.SABLE, GRAVIER, DES EAUX CHARGEES ETC.
EN USAGES PEU SEVERES DANS L'AGRICULTURE, INDUSTRIE ET CONSTRUCTION. EN PARTICULIER DANS L'USAGE DES CLIMATS TRES FROIDS.

ID		BP		VACUUM	BR/r	W	L
inch	mm	bar	psi	m/H ₂ O	mm	g/m	m
3/4"	19	17	247	9	105	360	30/50
1"	25	17	247	9	115	480	30/50
	30	15	218	9	120	550	30/50
1 1/4"	32	14	203	9	125	580	30/50
	35	13	189	9	130	640	30/50
1 1/2"	38	13	189	9	140	670	30/50
	40	12	174	9	155	700	30/50
	45	12	174	9	170	870	30/50
2"	51	12	174	9	185	975	30/50
	55	12	174	9	200	1080	30/50
	60	12	174	9	220	1250	30/50
2 1/2"	63	11	160	9	240	1350	30/50
	70	9	131	9	250	1580	30/50
3"	76	9	131	9	275	1700	30/50
	80	9	131	9	285	1800	20/30
	90	7	102	8	330	2100	20/30
4"	102	7	102	8	365	2600	20/30
	110	7	102	8	415	2900	20/30
	120	7	102	7	490	3200	20/30
5"	127	6	87	7	510	3650	20/30
6"	152	6	87	7	605	5100	20/30
8"	203	4	58	6	810	7850	10



- 30 °C / + 50 °C
- 22 °F / +122 °F

MARKING / BESCHRIFTUNG / MARCATURA / MARQUAGE: INK-JET

SEL LAGINA C ** mm (month/year)

NORMS NORMEN NORME NORMES	ISO 1307	COLOUR FARBEN COLORI COULEUR	
------------------------------------	----------	---------------------------------------	--

Superelastic Medium Duty Suction&Delivery



CORRUGATED EXTERNAL HELIX (-40 °C)



CONSTRUCTION : STRONG, FLEXIBLE AND SMOOTH SPECIAL SUPERELASTIC MATERIAL.
SHOCK RESISTANT PVC SPIRAL.
APPLICATION : CRUSHING, CHEMICAL AGENTS, ABRASION AND WEATHER RESISTANT, CORRUGATED SLIDING OUTSIDE.
FOR MEDIUM DUTY SUCTION AND DELIVERY OF WATER, SALT WATER, LIGHT CHEMICALS, LIQUIDS ETC. IN AGRICULTURAL, INDUSTRIAL APPLICATIONS CONSTRUCTIONS, SEWER PURGING, SLUDGE, SLURRIES, WASTE MATTER, SAND AND GRAVEL, ETC. ESPECIALLY FOR USE IN EXTREMELY COLD CLIMATES.



KONSTRUKTION : STABILER, HOCHFLEXIBLER, GLATTER, KÄLTERESISTENTER, SUPER ELASTISCHER, PLASTIFIZIERTER PVC.
MIT VERSTÄRKUNGSSPIRALE AUS SCHLAG-UND DRUCKFESTEM PVC.
ANWENDUNG : ÄUSSERST STRAPAZIERFÄHIG UND BIEGSAM, DRUCK-UND ABRIEBFEST, WITTERUNGS-UND CHEMIKALIENBESTÄNDIG, GEWELLTE GLEITENDE AUSSENDECKE.
FÜR LEICHTE ANWENDUNGEN ZUM BE-UND ENTLADEN VON WASSER, SALZWASSER, LEICHTE CHEMIKALIEN, ABRASIVEN MEDIEN USW; FÜR LANDWIRTSCHAFT, INDUSTRIEN, BAUWERKE, IM HAUSHALT UND IN KANALISATIONEN, SPEZIELL ZUR VERWENDUNG IN EXTREM KALTEN GEBIETEN.



COSTRUZIONE : TUBO LISCI, LEGGERO E FLESSIBILE IN MATERIALE SPECIALE SUPERELASTICO.
SPIRALE DI RINFORZO IN PVC RIGIDO ANTI URTO E ANTISCHIACCIAMENTO.
IMPIEGO : ESTERNA ONDULATA, SCORREVOLE, RESISTENTE A CARICHI, ABRASIONE E AGENTI ATMOSFERICI ED A VARI PRODOTTI CHIMICI.
PER IMPIEGO MEDIO DI ASPIRAZIONE E MANDATA DI ACQUE, PRODOTTI CHIMICI LEGGERI, LIQUIDI A USO DOMESTICO, EDILIZIA, INDUSTRIA SPURGHII, AGRICOLTURA, SOLIDI ABRASIVI, SPECIALMENTE PER USO NEI CLIMI ESTRAMAMENTE FREDDI.



CONSTRUCTION : TUYAU LISSE ET FLEXIBLE EN MATIERE SPECIALE SUPERELASTIC.
SPIRE EN PVC RIGIDE ANTICHOC.
APPLICATION : SURFACE ONDULEE, GLISSANTE, RESISTANTE A L'ABRASION, LES AGENTS ATMOSPERIQUES, ECRASEMENT ET LA PLUPART DES PRODUITS CHIMIQUES.
ASPIRATION ET REFOULEMENT D'EAU PURE, SALEE, CHARGEE DES SOLUTIONS CHIMIQUES LEGERES,SABLE, GRAVIER, DES EAUX CHARGES ETC. EN USAGES PEU SEVERES DANS L'AGRICULTURE, INDUSTRIE ET CONSTRUCTION. EN PARTICULIER DANS L'USAGE DES CLIMATS EXTREMEMENT FROIDS.

ID		BP		VACUUM	BR/r	W	L
inch	mm	bar	psi	m/H ₂ O	mm	g/m	m
3/4"	19	16	232	9	100	360	30/50
1"	25	16	232	9	110	480	30/50
	30	14	203	9	115	550	30/50
1 1/4"	32	13	189	9	120	580	30/50
	35	12	174	9	125	640	30/50
1 1/2"	38	12	174	9	140	670	30/50
	40	11	160	9	150	700	30/50
	45	11	160	9	160	870	30/50
2"	51	11	160	9	170	975	30/50
	55	11	160	9	180	1080	30/50
	60	11	160	9	190	1250	30/50
2 1/2 "	63	10	145	9	210	1350	30/50
	70	8	116	9	220	1580	30/50
3"	76	8	116	9	240	1700	30/50
	80	8	116	9	250	1800	20/30
	90	7	102	8	290	2100	20/30
4"	102	7	102	8	320	2600	20/30
	110	7	102	8	380	2900	20/30
	120	7	102	7	480	3200	20/30
5"	127	6	87	7	500	3650	20/30
6"	152	6	87	7	600	5100	20/30
8"	203	4	58	6	800	7850	10



MARKING / BESCHRIFTUNG / MARCATURA / MARQUAGE: **INK-JET**

SEL KNIDOS C ** mm (month/year) → → →

NORMS NORMEN NORME NORMES	ISO 1307	COLOUR FARBEN COLORI COULEUR	
------------------------------------	----------	---------------------------------------	--

Fire Fighting

Feuerwehrschräuche

Antincendio

Lutte contre l'incendie

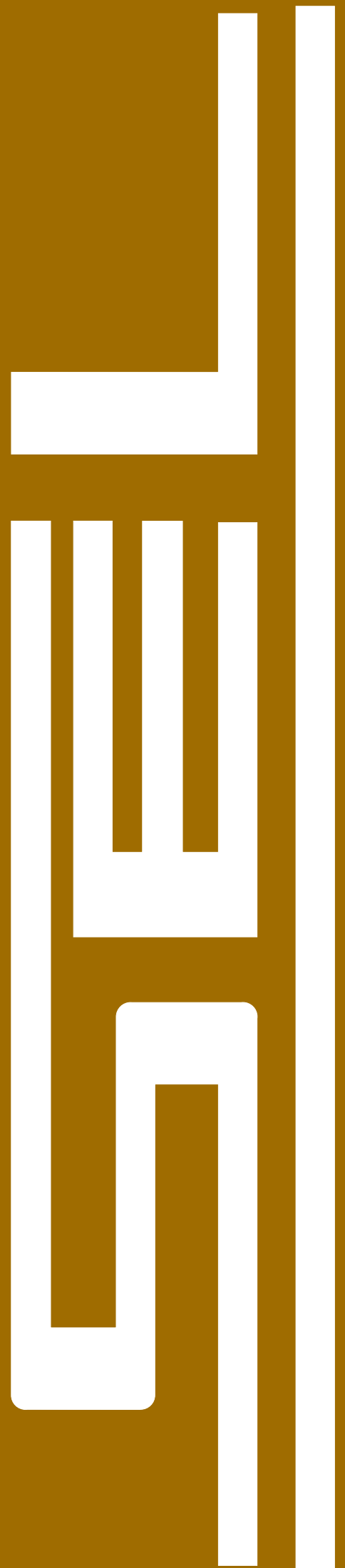



Fire Extinguisher



 TUBE : SPECIAL SYNTHETIC RUBBER.
 REINFORCEMENT : HIGH TENSILE SYNTHETIC TEXTILE.
 COVER : OZONE, ABRASION, AND WEATHER RESISTANT SPECIAL SYNTHETIC RUBBER.
 APPLICATION : FOR FIRE EXTINGUISHERS.

 SEELE : SPEZIELLER SYNTHETISCHER GUMMI.
 EINLAGE : HOCHZUGFESTE SYNTHETISCHE TEXTILEINLAGE.
 DECKE : OZON-, ABRIEB- UND WETTERBESTÄNDIGER, SPEZIELLER SYNTHETISCHER GUMMI.
 ANWENDUNG : ALS FEUERLÖSCHERSCHLAUCH.

 SOTTOSTRATO : GOMMA SPECIALE SINTETICA.
 RINFORZO : INSERZIONI TESSILI AD ALTA TENACITÀ.
 COPERTURA : GOMMA SINTETICA RESISTENTE ALL'ABRASIONE, ALL'OZONO ED AGLI AGENTI ATMOSFERICI.
 IMPIEGO : PER L'ESTINTORI.

 TUBE : CAOUTCHOUC SPECIAL SYNTHETIQUE.
 RENFORCEMENT : INSERTION TEXTILE HAUTE TENACITE.
 REVETEMENT : CAOUTCHOUC SPECIAL SYNTHETIQUE, RESISTANT A L'OZONE, A L'ABRASION, ET AUX AGENTS ATMOSPHERIQUES.
 APPLICATION : POUR LES EXTINCTEURS D'INCENDIE.

ID		OD	WP		BP		W	L
inch	mm	mm	bar	psi	bar	psi	g/m	m
3/8"	10	16	20	290	70	1015	150	>10
1/2"	13	21	20	290	70	1015	250	>10
5/8"	16	25	20	290	70	1015	350	>10



MARKING / BESCHRIFTUNG / MARCATURA / MARQUAGE: **EMBOSSED OR INK JET**

SEL GHOST FIRE EXTINGUISHER HOSE 2 MPa (20 BAR) (mm) (YEAR)**

NORMS NORMEN NORME NORMES	ISO 1307	COLOUR FARBEN COLORI COULEUR	
------------------------------------	----------	---------------------------------------	--

Fire Fighting Hose

EN 1947:2002-1/ CAT.I TYPE A-CLASS 1



TUBE : NATURAL AND SYNTHETIC RUBBER.
 REINFORCEMENT : HIGH TENSILE SYNTHETIC TEXTILE.
 COVER : FLAME, ABRASION, WEATHER AND OZONE RESISTANT SYNTHETIC RUBBER.
 APPLICATION : FOR FIRE FIGHTING VEHICLES.



SEELE : NATUR UND SYNTHETISCHER KAUSCHUK.
 EINLAGE : HOCHZUGFESTE SYNTHETISCHE TEXTILEINLAGE.
 DECKE : ABRIEBFESTER, WETTER- UND OZONBESTÄNDIGER, FLAMMWIDRIGER, SYNTHETISCHER GUMMI.
 ANWENDUNG : FÜR FEUERWEHRFAHRZEUGE.



SOTTOSTRATO : GOMMA NATURALE E SINTETICA.
 RINFORZO : INSERZIONI TESSILI AD ALTA TENACITÀ
 COPERTURA : GOMMA SINTETICA RESISTENTE ALLA FIAMMA, ALL'ABRASIONE, ALL'OZONO ED AGLI AGENTI ATMOSFERICI.
 IMPIEGO : PER I VEICOLI ANTINCENDIO



TUBE : CAOUTCHOUC NATUREL ET SYNTHETIQUE.
 RENFORCEMENT : INSERTION TEXTILE HAUTE TENACITE.
 REVETEMENT : CAOUTCHOUC SYNTHETIQUE RESISTANT A LA FLAMME, A L'ABRASION, A L'OZONE ET AUX AGENTS ATMOSPHERIQUES.
 APPLICATION : SUR LES ENROULEURS DES VEHICULES DE PROTECTION D'INCENDIE.

ID		OD	WP		BP		BR/r	W	L
inch	mm	mm	bar	psi	bar	psi	mm	g/m	m
1/2"	12.7	21	15	218	45	623	120	305	40-46-61
3/4"	19	32	15	218	45	623	190	710	40-46-61
1"	25.4	38	15	218	45	623	200	850	40-46-61
1 1/4"	32	44	15	218	45	623	280	960	40-46-61



-20°C / + 70°C
 - 4°F / +158°F



MARKING / BESCHRIFTUNG / MARCATURA / MARQUAGE: **TRANSFER TAPE OR EMBOSSED**



MILAS - 15

FIRE FIGHTING HOSE / TS EN 1947:2002 -1- A -1 W.P. 15 Bar (218 PSI)



NORMS
 NORMEN
 NORME
 NORMES

TS EN 1947+A1 EN 1947+A1
 CAT.I/TYPE A/CLASS 1
 ISO 1307

COLOUR
 FARBEN
 COLORI
 COULEUR



Fire Fighting Hose

EN 1947:2002-1/ CAT.II TYPE C-CLASS 1



TUBE : NATURAL AND SYNTHETIC RUBBER.
 REINFORCEMENT : HIGH TENSILE SYNTHETIC TEXTILE.
 COVER : FLAME, ABRASION, WEATHER AND OZONE RESISTANT SYNTHETIC RUBBER.
 APPLICATION : FOR FIRE FIGHTING VEHICLES.



SEELE : NATUR UND SYNTHETISCHER KAUTSCHUK.
 EINLAGE : HOCHZUGFESTE SYNTHETISCHE TEXTILEINLAGE.
 DECKE : ABRIEBFESTER, WETTER- UND OZONBESTÄNDIGER, FLAMMWIDRIGER, SYNTHETISCHER GUMMI.
 ANWENDUNG : FÜR FEUERWEHRFAHRZEUGE.



SOTTOSTRATO : GOMMA NATURALE E SINTETICA.
 RINFORZO : INSERZIONI TESSILI AD ALTA TENACITÀ.
 COPERTURA : GOMMA SINTETICA RESISTENTE ALLA FIAMMA, ALL'ABRASIONE, ALL'OZONO ED AGLI AGENTI ATMOSFERICI.
 IMPIEGO : PER I VEICOLI ANTINCENDIO.



TUBE : CAOUTCHOUC NATUREL ET SYNTHETIQUE.
 RENFORCEMENT : INSERTION TEXTILE HAUTE TENACITE.
 REVETEMENT : CAOUTCHOUC SYNTHETIQUE RESISTANT A LA FLAMME A L'ABRASION, A L'OZONE ET AUX AGENTS ATMOSPHERIQUES.
 APPLICATION : SUR LES ENROULEURS DES VEHICULES DE PROTECTION D'INCENDIE.

ID		OD		WP		BP		BR/r	W	L
inch	mm	mm	bar	psi	bar	psi	mm	g/m	m	
1/2"	12.7	21.5	40	580	120	1740	120	315	40-46-61	
3/4"	19	32.5	40	580	120	1740	190	715	40-46-61	
1"	25.4	39	40	580	120	1740	200	870	40-46-61	
1 1/4"	32	45	40	580	120	1740	280	975	40-46-61	



-20°C / + 70°C
 - 4°F / +158°F



MARKING / BESCHRIFTUNG / MARCATURA / MARQUAGE: **TRANSFER TAPE OR EMBOSSED**

SEL MILAS - 40 FIRE FIGHTING HOSE / TS EN 1947:2002 -2- C - 1 W.P. 40 Bar (580 PSI)

NORMS NORMEN NORME NORMES	TS EN 1947+A1 EN 1947+A1 CAT.II/TYPE C/CLASS 1 ISO 1307	COLOUR FARBEN COLORI COULEUR	
------------------------------------	---	---------------------------------------	--



Thermorub® Fire Reel



TUBE : SPECIAL THERMORUB COMPOUND.
 REINFORCEMENT : HIGH TENSILE SYNTHETIC TEXTILE.
 COVER : ABRASION, HEAT AND WEATHER RESISTANT THERMORUB COMPOUND.
 APPLICATION : FOR FIRE FIGHTING APPLICATIONS IN FIRE REELS.



SEELE : SPEZIELLE SYNTHETISCHE THERMORUB MISCHUNG.
 EINLAGEN : HOCHFESTES SYNTHETISCHES TEXTILGEWEBE.
 DECKE : ABRIEBFESTE, HITZE-UND WITTERUNGSBESTÄNDIGE, SPEZIELLE THERMORUB MISCHUNG.
 ANWENDUNG : GEEIGNET FÜR FEUERLÖSCHGERÄTE UND HASPELSCHLAUCH.



SOTTOSTRATO : MESCOLA SPECIALE IN THERMORUB.
 RINFORZO : INSERZIONI TESSILI AD ALTA TENACITÀ.
 COPERTURA : MESCOLA THERMORUB RESISTENTE ALL ABRASIONE, OZONO, AGENTI ATMOSFERICI ED ALLE SUPERFICI CALDE.
 IMPIEGO : TUBO ANTINCENDIO PER INSTALLAZIONI FISSE.



TUBE : TUYAU LISSE EN MATIERE SPECIALE THERMORUB.
 RENFORCEMENT : INSERTION TEXTILE HAUTE TENACITE.
 REVETEMENT : MATIERE SPECIALE THERMORUB RESISTANTE A L'ABRASION, A LA FLAMME ET LES AGENTS ATMOSPHERIQUES.
 APPLICATION : LUTTE CONTRE L'INCENDIE, POUR LES INSTALLATIONS FIXES.



CODE: TBY71

inch	mm	mm	bar	psi	bar	psi	mm	g/m	m
3/4"	19	26	12	174	42	609	230	385	20-100
1"	25	33	12	174	42	609	300	565	20-100
1 1/4"	33	43	7	102	25	363	385	910	20-60

CODE: TBY72

inch	mm	mm	bar	psi	bar	psi	mm	g/m	m
1/2"	12,5	19	20	290	70	1015	200	235	20-100
3/4"	19	26	20	290	70	1015	230	380	20-100
1"	25	33	20	290	70	1015	300	560	20-70



- 5 °C / + 60 °C
 +23 °F / +140 °F

MARKING / BESCHRIFTUNG / MARCATURA / MARQUAGE: **INK-JET**

SEL EN 694 - ** mm - ** MPa (** bar) - quarter / year - KIWA → → →

NORMS NORMEN NORME NORMES	EN 694 ISO 1307 KIWA	COLOUR FARBEN COLORI COULEUR	
------------------------------------	----------------------------	---------------------------------------	--

Textile Braided CO₂

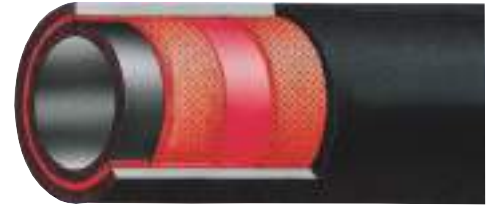

 TUBE : CO₂ RESISTANT SPECIAL SYNTHETIC RUBBER.
 REINFORCEMENT : HIGH TENSILE SYNTHETIC TEXTILE.
 COVER : OIL, ABRASION, AND WEATHER RESISTANT SPECIAL SYNTHETIC RUBBER.
 APPLICATION : FOR HIGH PRESSURE TRANSFER OF CO₂.

 SEELE : SPEZIELLER SYNTHETISCHER GUMMI, BESTÄNDIG GEGEN CO₂.
 EINLAGE : HOCHZUGFESTE SYNTHETISCHE TEXTILEINLAGE.
 DECKE : ÖL-, ABRIB- UND WETTERBESTÄNDIGER; SPEZIELLER SYNTHETISCHER GUMMI.
 ANWENDUNG : ZUM BEFÖRDERN VON CO₂ UNTER HOCHDRUCK.

 SOTTOSTRATO : GOMMA SPECIALE SINTETICA RESISTENTE AL CO₂.
 RINFORZO : INSERZIONI TESSILI AD ALTA TENACITÀ.
 COPERTURA : GOMMA SINTETICA RESISTENTE ALL'ABRASIONE, ALL'OLIO ED AGLI AGENTI ATMOSFERICI.
 IMPIEGO : PER IL TRASFERIMENTO DI CO₂ AD ALTA PRESSIONE.

 TUBE : CAOUTCHOUC SPECIAL SYNTHETIQUE, RESISTANT AU CO₂.
 RENFORCEMENT : INSERTION TEXTILE HAUTE TENACITE.
 REVETEMENT : CAOUTCHOUC SPECIAL SYNTHETIQUE, RESISTANT AUX HUILES, A L'ABRASION, ET AUX AGENTS ATMOSPHERIQUES.
 APPLICATION : POUR LE TRANSFERT DU CO₂ A HAUTE PRESSION.

ID		OD	WP		BP		W	L
inch	mm	mm	bar	psi	bar	psi	g/m	m
9/32"	7	18	100	1450	400	5800	270	>10
19/64"	7.5	18	100	1450	400	5800	260	>10
5/16"	8	17	100	1450	400	5800	220	>10

 -25°C / + 70°C
 -13°F / +158°F

MARKING / BESCHRIFTUNG / MARCATURA / MARQUAGE: **EMBOSSSED**

SEL FUMO CO₂ HOSE 10 MPa (100 BAR) (mm) (YEAR)**

NORMS NORMEN NORME NORMES	ISO 1307	COLOUR FARBEN COLORI COULEUR	
------------------------------------	----------	---------------------------------------	--

Air - Gas

Luft- Gas

Aria- Gas

Air - Gaz



Light Duty Air

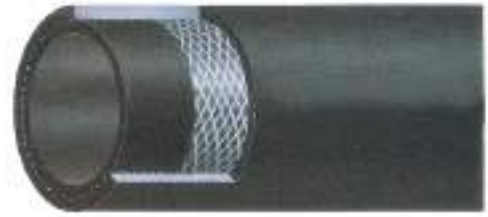

TUBE : OIL-MIST RESISTANT NATURAL AND SYNTHETIC RUBBER.
 REINFORCEMENT : HIGH TENSILE SYNTHETIC TEXTILE.
 COVER : ABRASION, OZONE AND WEATHER RESISTANT SMOOTH NATURAL AND SYNTHETIC RUBBER.
 APPLICATION : FOR PNEUMATIC EQUIPMENT AND TOOLS.



SEELE : ÖLBESTÄNDIGER NATUR- UND SYNTHETISCHER GUMMI.
 EINLAGE : HOCHZUGFESTE SYNTHETISCHE TEXTILEINLAGE.
 DECKE : ABRIB-, OZON- UND WETTERBESTÄNDIGER SYNTHETISCHER GUMMI, GLATT.
 ANWENDUNG : FÜR PNEUMATISCHE WERKZEUGE UND BAUGERÄTE.



SOTTOSTRATO : GOMMA NATURALE E SINTETICA RESISTENTE ALL'OLIO NEBULIZZATO.
 RINFORZO : INSERZIONI TESSILI AD ALTA TENACITÀ.
 COPERTURA : GOMMA SINTETICA LISCIA RESISTENTE ALL'ABRASIONE, ALL'OZONO ED AGLI AGENTI ATMOSFERICI.
 IMPIEGO : MANDATA D'ARIA COMPRESSA PER COMPRESSORI ED UTENSILI PNEUMATICI.



TUBE : CAOUTCHOUC NATUREL ET SYNTHETIQUE RESISTANT AUX PROJECTIONS D'HUILE.
 RENFORCEMENT : INSERTION TEXTILE HAUTE TENACITE.
 REVETEMENT : CAOUTCHOUC NATUREL ET SYNTHETIQUE LISSE RESISTANT A L'ABRASION, A L'OZONE ET AUX AGENTS ATMOSPHERIQUES.
 APPLICATION : POUR L'AIR COMPRIME LUBRIFIE ET LES EQUIPEMENTS PNEUMATIQUES.



ID		OD	WP		BP		W	L
inch	mm	mm	bar	psi	bar	psi	g/m	m
3/16"	4,5	10	10	145	40	580	100	100
1/4"	6	11	10	145	40	580	105	100
5/16"	8	14	10	145	40	580	160	100
3/8"	10	16	10	145	40	580	190	100
1/2"	13	19	10	145	40	580	235	100
5/8"	16	23	10	145	40	580	335	100
3/4"	19	27	10	145	40	580	440	100
1"	25	34	10	145	40	580	635	100



-25°C / + 70°C
 -13°F / +158°F

MARKING / BESCHRIFTUNG / MARCATURA / MARQUAGE: **EMBOSSED OR INK JET**

SEL LONG-KOMP LIGHT DUTY AIR HOSE (** mm) 1.0 MPA (10 BAR) (YEAR)

NORMS NORMEN NORME NORMES	ISO 1307	COLOUR FARBEN COLORI COULEUR	 
------------------------------------	----------	---------------------------------------	--

Medium Duty Air

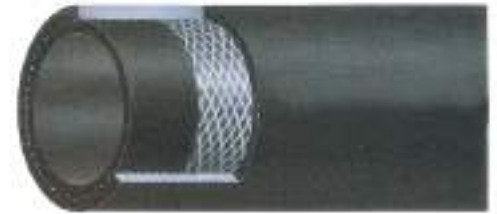

TUBE : OIL-MIST RESISTANT NATURAL AND SYNTHETIC RUBBER.
 REINFORCEMENT : HIGH TENSILE SYNTHETIC TEXTILE.
 COVER : ABRASION, OZONE AND WEATHER RESISTANT SMOOTH NATURAL AND SYNTHETIC RUBBER.
 APPLICATION : MEDIUM DUTY SERVICE FOR AIR AND PNEUMATIC TOOLS SPECIALLY IN MINES, QUARRIES AND CONSTRUCTIONS.



SEELE : ÖLNEBELBESTÄNDIGER NATUR- UND SYNTHETISCHER GUMMI.
 EINLAGE : HOCHZUGFESTE SYNTHETISCHE TEXTILEINLAGE.
 DECKE : ABRIB- OZON- UND WETTERBESTÄNDIGER SYNTHETISCHER GUMMI. GLATT.
 ANWENDUNG : IM MITTLEREN DRUCKBEREICH FÜR LUFT UND PNEUMATISCH OPERIERENDE MASCHINEN SPEZIELL IN MINEN UND BAUBRANCHE.



SOTTOSTRATO : GOMMA NATURALE E SINTETICA RESISTENTE ALL'OLIO NEBULIZZATO.
 RINFORZO : INSERZIONI TESSILI AD ALTA TENACITÀ.
 COPERTURA : GOMMA NATURALE E SINTETICA LISCIA RESISTENTE ALL'ABRASIONE, ALL'OZONO ED AGLI AGENTI ATMOSFERICI .
 IMPIEGO : MANDATA D'ARIA COMPRESSA PER COMPRESSORI, NELLE MINIERE, CAVE E COSTRUZIONE.



TUBE : CAOUTCHOUC NATUREL ET SYNTHETIQUE RESISTANT AUX PROJECTIONS D'HUILE.
 RENFORCEMENT : INSERTION TEXTILE HAUTE TENACITE.
 REVETEMENT : CAOUTCHOUC NATUREL ET SYNTHETIQUE LISSE RESISTANT A L'ABRASION, A L'OZONE ET AUX AGENTS ATMOSPERIQUES.
 APPLICATION : POUR AIR ET EQUIPEMENTS PNEUMATIQUES EN PARTICULIER DANS L'INDUSTRIE MINIERE, ET LA CONSTRUCTION.

ID		OD	WP		BP		W	L
inch	mm	mm	bar	psi	bar	psi	g/m	m
1/4"	6	13	20	290	64	928	160	100
5/16"	8	15	20	290	64	928	195	100
3/8"	10	18	20	290	64	928	270	100
1/2"	13	22	20	290	64	928	395	100
5/8"	16	25	20	290	64	928	450	100
3/4"	19	29	20	290	64	928	585	100
1"	25	37	20	290	64	928	1890	100



-25°C / + 70°C
 -13°F / +158°F

MARKING / BESCHRIFTUNG / MARCATURA / MARQUAGE: **EMBOSSED OR INK JET**

SEL LONG-KOMP MEDIUM DUTY AIR (** mm) 2.0 MPA (20 BAR) (YEAR)

NORMS
 NORMEN
 NORME
 NORMES

ISO 1307

COLOUR
 FARBEN
 COLORI
 COULEUR



Medium Duty Air

ANTISTATIC



TUBE : OIL-MIST RESISTANT NATURAL AND SYNTHETIC ANTISTATIC RUBBER.
 REINFORCEMENT : HIGH TENSILE SYNTHETIC TEXTILE.
 COVER : ABRASION, OZONE AND WEATHER RESISTANT SMOOTH NATURAL AND SYNTHETIC RUBBER.
 APPLICATION : MEDIUM DUTY SERVICE FOR AIR AND PNEUMATIC TOOLS SPECIALLY IN MINES, QUARRIES AND CONSTRUCTIONS.



SEELE : ÖLNEBELBESTÄNDIGER NATUR- UND SYNTHETISCHER ANTISTATISCHER GUMMI.
 EINLAGE : HOCHZUGFESTE SYNTHETISCHE TEXTILEINLAGE.
 DECKE : ABRIEB- OZON- UND WETTERBESTÄNDIGER SYNTHETISCHER GUMMI, GLATT.
 ANWENDUNG : IM MITTLEREN DRUCKBEREICH FÜR LUFT UND PNEUMATISCH OPERIERENDE MASCHINEN SPEZIELL IN MINEN UND BAUBRANCHE.



SOTTOSTRATO : GOMMA ANTISTATICA, NATURALE E SINTETICA RESISTENTE ALL'OLIO NEBULIZZATO.
 RINFORZO : INSERZIONI TESSILI AD ALTA TENACITÀ.
 COPERTURA : GOMMA NATURALE E SINTETICA LISCIA RESISTENTE ALL'ABRASIONE, ALL'OZONO ED AGLI AGENTI ATMOSFERICI.
 IMPIEGO : MANDATA D'ARIA COMPRESSA PER COMPRESSORI, NELLE MINIERE, CAVE E COSTRUZIONE.



TUBE : CAOUTCHOUC ANTISTATIQUE, NATUREL ET SYNTHETIQUE RESISTANT AUX PROJECTIONS D'HUILE.
 RENFORCEMENT : INSERTION TEXTILE HAUTE TENACITE.
 REVETEMENT : CAOUTCHOUC NATUREL ET SYNTHETIQUE LISSE RESISTANT A L'ABRASION, A L'OZONE ET AUX AGENTS ATMOSPERIQUES.
 APPLICATION : POUR AIR ET EQUIPEMENTS PNEUMATIQUES EN PARTICULIER DANS L'INDUSTRIE MINIERE, ET LA CONSTRUCTION.

ID		OD	WP		BP		W	L
inch	mm	mm	bar	psi	bar	psi	g/m	m
1/4"	6	12	20	290	60	870	125	100
5/16"	8	15	20	290	60	870	185	100
3/8"	10	17	20	290	60	870	215	100
1/2"	13	21	20	290	60	870	305	100
5/8"	16	25	20	290	60	870	415	100
3/4"	19	29	20	290	60	870	530	100
1"	25	36	20	290	60	870	750	100

OPTIONS / OPTIONEN / OPZIONI / OPTIONS

Upon Request : Antistatic cover
 Auf Anfrage : Antistatisch decke
 Su Richiesta : Copertura antistatico
 Sur Demande : Revêtement antistatique



: ≤1x 10⁶ Ω/m



-25°C / + 70°C
 -13°F / +158°F

MARKING / BESCHRIFTUNG / MARCATURA / MARQUAGE: **EMBOSSED OR INK JET**

SEL LONG-KOMP A/S MEDIUM DUTY AIR (mm) 2.0 MPA (20 BAR) (YEAR)**

NORMS NORMEN NORME NORMES	ISO 1307	COLOUR FARBEN COLORI COULEUR	 
------------------------------------	----------	---------------------------------------	--

Multipurpose



TUBE : SPECIAL SYNTHETIC RUBBER.
 REINFORCEMENT : HIGH TENSILE SYNTHETIC TEXTILE.
 COVER : ABRASION, HEAT, OZONE AND WEATHER RESISTANT SMOOTH SPECIAL SYNTHETIC RUBBER.
 APPLICATION : TO CONVEY AIR, OIL, COLD / HOT WATER.



SEELE : SPEZIELLER SYNTHETISCHER GUMMI.
 EINLAGE : HOCHZUGFESTE TEXTILEINLAGE.
 DECKE : ABRIEB- OZON- UND WETTERBESTÄNDIGER SYNTHETISCHER GUMMI, GLATT.
 ANWENDUNG : ZUR BEFÖRDERUNG VON LUFT; ÖL; HEISS- UND KALTWASSER.



SOTTOSTRATO : GOMMA SPECIALE SINTETICA.
 RINFORZO : INSERZIONI TESSILI AD ALTA TENACITÀ.
 COPERTURA : LISCIA IN GOMMA SPECIALE SINTETICA RESISTENTE ALL' ABRASIONE, AL CALORE, ALL'OZONO ED AGLI AGENTI ATMOSFERICI.
 IMPIEGO : PER PASSAGGIO D'ARIA, OLIO, ACQUA CALDA / FREDDA.



TUBE : CAOUTCHOUC SYNTHETIQUE SPECIAL.
 RENFORCEMENT : INSERTION TEXTILE HAUTE TENACITE.
 REVETEMENT : CAOUTCHOUC SYNTHETIQUE SPECIAL, LISSE RESISTANT A L'ABRASION, A L'OZONE, LA CHALEUR ET AUX AGENTS ATMOSPHERIQUES.
 APPLICATION : POUR TRANSFERT D'AIR, D'HUILE, D'EAU FROIDE / CHAUDE.

ID		OD		WP		BP		W	L
inch	mm	mm	mm	bar	psi	bar	psi	g/m	m
1/4"	6	11		10	145	30	435	80	100
5/16"	8	14		10	145	30	435	20	100
3/8"	10	16		10	145	30	435	145	100
1/2"	13	20		10	145	30	435	215	100
5/8"	16	23		10	145	30	435	255	100
3/4"	19	27		10	145	30	435	340	100
1"	25	34		10	145	30	435	490	100

inch	mm	mm	bar	psi	bar	psi	g/m	m
1/4"	6	13	20	290	60	870	125	100
5/16"	8	15	20	290	60	870	150	100
3/8"	10	18	20	290	60	870	210	100
1/2"	13	22	20	290	60	870	295	100
5/8"	16	25	20	290	60	870	345	100
3/4"	19	29	20	290	60	870	445	100
1"	25	37	20	290	60	870	690	100



-40°C / + 70°C
 -40°F / +158°F

MARKING / BESCHRIFTUNG / MARCATURA / MARQUAGE: **EMBOSSED OR INK JET**

SEL LONG-MULTI MULTIPURPOSE HOSE (**") W.P. ** BAR (LOT)

NORMS NORMEN NORME NORMES	ISO 1307	COLOUR FARBEN COLORI COULEUR	
------------------------------------	----------	---------------------------------------	--

Multipurpose

EPDM



 TUBE : EPDM RUBBER.
 REINFORCEMENT : HIGH TENSILE SYNTHETIC TEXTILE.
 COVER : ABRASION, HEAT, OZONE AND WEATHER RESISTANT SMOOTH EPDM RUBBER.
 APPLICATION : TO CONVEY AIR, OIL, COLD / HOT WATER AND NON AGGRESSIVE CHEMICALS.

 SEELE : EPDM GUMMI.
 EINLAGE : HOCHZUGFESTE TEXTILEINLAGE.
 DECKE : ABRIB- OZON- UND WETTERBESTÄNDIGER EPDM GUMMI, GLATT.
 ANWENDUNG : ZUR BEFÖRDERUNG VON LUFT; ÖL; HEISS- UND KALTWASSER SOWIE NICHT AGRESSIVEN CHEMIKALIEN.

 SOTTOSTRATO : GOMMA EPDM SPECIALE SINTETICA.
 RINFORZO : INSERZIONI TESSILI AD ALTA TENACITÀ.
 COPERTURA : LISCIA IN GOMMA EPDM RESISTENTE ALL' ABRASIONE, AL CALORE, ALL'OZONO ED AGLI AGENTI ATMOSFERICI.
 IMPIEGO : PER PASSAGGIO D'ARIA, OLIO, ACQUA CALDA / FREDDA E PRODOTTI CHIMICI CON MEDIA AGGRESSIVITA.

 TUBE : CAOUTCHOUC EPDM.
 REINFORCEMENT : INSERTION TEXTILE HAUTE TENACITE.
 REVETEMENT : CAOUTCHOUC EPDM, LISSE RESISTANT A L'ABRASION, A L'OZONE, A LA CHALEUR ET AUX AGENTS ATMOSPHERIQUES.
 APPLICATION : POUR TRANSFERT D'AIR, D'HUILE, D'EAU FROIDE / CHAUDE ET PRODUITS CHIMIQUES NON AGRESSIFS.

ID		OD	WP		BP		W	L
inch	mm	mm	bar	psi	bar	psi	g/m	m
1/4"	6	11	10	145	30	435	35	100
5/16"	8	14	10	145	30	435	50	100
3/8"	10	16	10	145	30	435	65	100
1/2"	13	20	10	145	30	435	80	100
5/8"	16	23	10	145	30	435	100	100
3/4"	19	27	10	145	30	435	115	100
1"	25	34	10	145	30	435	150	100

inch	mm	mm	bar	psi	bar	psi	g/m	m
1/4"	6	13	20	290	60	870	125	100
5/16"	8	15	20	290	60	870	150	100
3/8"	10	18	20	290	60	870	210	100
1/2"	13	22	20	290	60	870	295	100
5/8"	16	25	20	290	60	870	345	100
3/4"	19	29	20	290	60	870	445	100
1"	25	37	20	290	60	870	690	100



MARKING / BESCHRIFTUNG / MARCATURA / MARQUAGE: **EMBOSSED OR INK JET**

SEL PRIME MULTIPURPOSE HOSE (*) W.P. ** BAR (LOT)**

NORMS NORMEN NORME NORMES	ISO 1307	COLOUR FARBEN COLORI COULEUR	
------------------------------------	----------	---------------------------------------	--

Light Duty Air



TUBE : NATURAL AND SYNTHETIC RUBBER.
 REINFORCEMENT : HIGH TENSILE SYNTHETIC TEXTILE.
 COVER : ABRASION, OZONE AND WEATHER RESISTANT SYNTHETIC RUBBER.
 APPLICATION : FOR PNEUMATIC EQUIPMENT AND TOOLS.



SEELE : NATUR- UND SYNTHETISCHER GUMMI
 EINLAGE : HOCHZUGFESTE SYNTHETISCHE TEXTILEINLAGE
 DECKE : ABRIEB-, OZON- UND WETTERBESTÄNDIGER SYNTHETISCHER GUMMI, GLATT
 ANWENDUNG : FÜR PNEUMATISCHE WERKZEUGE UND BAUGERÄTE



SOTTOSTRATO : GOMMA NATURALE E SINTETICA.
 RINFORZO : INSERZIONI TESSILI AD ALTA TENACITÀ.
 COPERTURA : GOMMA SINTETICA RESISTENTE ALL'ABRASIONE, ALL'OZONO ED AGLI AGENTI ATMOSFERICI .
 IMPIEGO : MANDATA D'ARIA COMPRESSA PER COMPRESSORI ED UTENSILI PNEUMATICI.



TUBE : CAOUTCHOUC NATUREL ET SYNTHETIQUE.
 REINFORCEMENT : INSERTION TEXTILE HAUTE TENACITE.
 REVETEMENT : CAOUTCHOUC SYNTHETIQUE RESISTANT A L'ABRASION, A L'OZONE ET AUX AGENTS ATMOSPHERIQUES.
 APPLICATION : POUR AIR COMPRI ME ET EQUIPEMENT PNEUMATIQUE.

ID		OD	WP		BP		W	L
inch	mm	mm	bar	psi	bar	psi	g/m	m
1/2"	12.7	22	10	145	40	580	400	40-46-61
5/8"	16	25	10	145	40	580	444	40-46-61
3/4"	19	29	10	145	40	580	564	40-46-61
1"	25.4	36	10	145	40	580	661	40-46-61
1 1/4"	32	44	10	145	40	580	1051	40-46-61
1 1/2"	38	51	10	145	40	580	1341	40-46-61
1 3/4"	44.5	57	10	145	40	580	1426	40-46-61
2"	50.8	63	10	145	40	580	1619	40-46-61
2 1/2"	63.5	78	10	145	40	580	2368	40-46-61
3"	76.2	92	10	145	40	580	3074	40-46-61
4"	101.6	117	10	145	40	580	3828	40-46-61

OPTIONS / OPTIONEN / OPZIONI / OPTIONS

Upon Request : Type 4 (16 Bar) - type 5 (25 Bar)
 Auf Anfrage : Type 4 (16 Bar) - type 5 (25 Bar)
 Su Richiesta : Type 4 (16 Bar) - type 5 (25 Bar)
 Sur Demande : Type 4 (16 Bar) - type 5 (25 Bar)





-25°C / + 70°C
 -13°F / +158°F



MARKING / BESCHRIFTUNG / MARCATURA / MARQUAGE: **TRANSFER TAPE OR EMBOSSED**

SEL SKY-10 LIGHT DUTY AIR HOSE / TS 745 - EN ISO 2398 Type 1 Class A- W.P. 10 Bar (145 PSI)

NORMS NORMEN NORME NORMES	TS 745/EN ISO 2398 TYPE 1-CLASS A ISO 1307	COLOUR FARBEN COLORI COULEUR	 
------------------------------------	---	---------------------------------------	---

Medium Duty Air



TUBE : OIL-MIST RESISTANT NATURAL AND SYNTHETIC RUBBER.
 REINFORCEMENT : HIGH TENSILE SYNTHETIC TEXTILE.
 COVER : ABRASION, OZONE AND WEATHER RESISTANT SYNTHETIC RUBBER.
 APPLICATION : MEDIUM DUTY SERVICE FOR AIR AND PNEUMATIC TOOLS SPECIALLY IN MINES, QUARRIES AND CONSTRUCTIONS.



SEELE : ÖLNEBELBESTÄNDIGER NATUR- UND SYNTHETISCHER GUMMI.
 EINLAGE : HOCHZUGFESTE SYNTHETISCHE TEXTILEINLAGE.
 DECKE : ABRIB- OZON- UND WETTERBESTÄNDIGER SYNTHETISCHER GUMMI, GLATT.
 ANWENDUNG : IM MITTLEREN DRUCKBEREICH FÜR LUFT UND PNEUMATISCH OPERIERENDE MASCHINEN SPEZIELL IN MINEN, STEINBRÜCHEN UND BAUBRANCHE.



SOTTOSTRATO : GOMMA NATURALE E SINTETICA RESISTENTE ALL'OLIO NEBULIZZATO.
 RINFORZO : INSERZIONI TESSILI AD ALTA TENACITÀ.
 COPERTURA : GOMMA SINTETICA RESISTENTE ALL'ABRASIONE, ALL'OZONO ED AGLI AGENTI ATMOSFERICI.
 IMPIEGO : MANDATA D'ARIA COMPRESSA PER COMPRESSORI, NELLE MINIERE, CAVE E COSTRUZIONE.



TUBE : CAOUTCHOUC NATUREL ET SYNTHETIQUE RESISTANT AUX PROJECTIONS D'HUILE.
 RENFORCEMENT : INSERTION TEXTILE HAUTE TENACITE.
 REVETEMENT : CAOUTCHOUC SYNTHETIQUE RESISTANT A L'ABRASION, A L'OZONE ET AUX AGENTS ATMOSPERIQUES.
 APPLICATION : POUR AIR ET EQUIPEMENTS PNEUMATIQUES EN PARTICULIER DANS L'INDUSTRIE MINIERE, ET LA CONSTRUCTION.

ID		OD	WP		BP		W	L
inch	mm	mm	bar	psi	bar	psi	g/m	m
1/2"	12.7	22	20	290	60	870	332	40-46-61
5/8"	16	25	20	290	60	870	374	40-46-61
3/4"	19	29	20	290	60	870	504	40-46-61
1"	25.4	36	20	290	60	870	670	40-46-61
1 1/4"	32	44	20	290	60	870	955	40-46-61
1 1/2"	38	51	20	290	60	870	1177	40-46-61
1 3/4"	44.5	60	20	290	60	870	1630	40-46-61
2"	50.8	65	20	290	60	870	1655	40-46-61
2 1/2"	63.5	80	20	290	60	870	2450	40-46-61
3"	76.2	92	20	290	60	870	2650	40-46-61
4"	101.6	118	20	290	60	870	3810	40-46-61



-25°C / + 70°C
 -13°F / +158°F

MARKING / BESCHRIFTUNG / MARCATURA / MARQUAGE: **TRANSFER TAPE OR EMBOSSED**

SEL SKY-20 MEDIUM DUTY AIR HOSE / W.P. 20 Bar (290 PSI)

NORMS NORMEN NORME NORMES	ISO 1307	COLOUR FARBEN COLORI COULEUR	
------------------------------------	----------	---------------------------------------	--

Heavy Duty Air



TUBE : OIL MIST RESISTANT NATURAL AND SYNTHETIC RUBBER.
 REINFORCEMENT : HIGH TENSILE SYNTHETIC TEXTILE.
 COVER : ABRASION, OZONE AND WEATHER RESISTANT SYNTHETIC RUBBER.
 APPLICATION : HEAVY DUTY SERVICE FOR AIR AND PNEUMATIC TOOLS SPECIALLY IN MINES, QUARRIES AND CONSTRUCTIONS.



SEELE : ÖLNEBELBESTÄNDIGER NATUR- UND SYNTHETISCHER GUMMI.
 EINLAGE : HOCHZUGFESTE SYNTHETISCHE TEXTILEINLAGE.
 DECKE : ABRASION- OZON- UND WETTERBESTÄNDIGER SYNTHETISCHER GUMMI. GLATT.
 ANWENDUNG : IM HOHEN DRUCKBEREICH FÜR LUFT UND PNEUMATISCH OPERIERENDE MASCHINEN SPEZIELL IN MINEN, STEINBRÜCHEN UND BAUBRANCHE.



SOTTOSTRATO : GOMMA NATURALE E SINTETICA RESISTANTE ALL'OLIO NEBULIZZATO.
 RINFORZO : INSERZIONI TESSILI AD ALTA TENACITÀ.
 COPERTURA : GOMMA SINTETICA RESISTENTE ALL'ABRASIONE, ALL'OZONO ED AGLI AGENTI ATMOSFERICI.
 IMPIEGO : MANDATA D'ARIA COMPRESSA AD ALTA PRESSIONE PER COMPRESSORI, NELLE MINIERE, CAVE E COSTRUZIONE.



TUBE : CAOUTCHOUC NATUREL ET SYNTHETIQUE RESISTANT AUX PROJECTIONS D'HUILE.
 RENFORCEMENT : INSERTION TEXTILE HAUTE TENACITE.
 REVETEMENT : CAOUTCHOUC SYNTHETIQUE RESISTANT A L'ABRASION, A L'OZONE ET AUX AGENTS ATMOSPHERIQUES.
 APPLICATION : POUR AIR ET EQUIPEMENTS PNEUMATIQUES EN USAGE INTENSIF EN PARTICULIER DANS L'INDUSTRIE MINIERE, ET LA CONSTRUCTION.

ID		OD	WP		BP		W	L
inch	mm	mm	bar	psi	bar	psi	g/m	m
1/2"	12.7	23	25	363	75	1088	380	40-46-61
5/8"	16	26	25	363	75	1088	450	40-46-61
3/4"	19	30	25	363	75	1088	570	40-46-61
1"	25.4	37	25	363	75	1088	720	40-46-61
1 1/4"	32	44	25	363	75	1088	950	40-46-61
1 1/2"	38	51	25	363	75	1088	1210	40-46-61
1 3/4"	44.5	60	25	363	75	1088	1660	40-46-61
2"	50.8	66	25	363	75	1088	1825	40-46-61
2 1/2"	63.5	80	25	363	75	1088	2505	40-46-61
2 3/4"	70	86	25	363	75	1088	2665	40-46-61
3"	76.2	92	25	363	75	1088	2785	40-46-61
4"	101.6	118	25	363	75	1088	3530	40-46-61



-25°C / + 70°C
 -13°F / +158°F

MARKING / BESCHRIFTUNG / MARCATURA / MARQUAGE: **TRANSFER TAPE OR EMBOSSED**

SEL SKY-25 HEAVY DUTY AIR HOSE W.P. 25 Bar (363 PSI)

NORMS NORMEN NORME NORMES	ISO 1307	COLOUR FARBEN COLORI COULEUR	
------------------------------------	----------	---------------------------------------	---

Steel Wire Reinforced Air



TUBE : SYNTHETIC NBR RUBBER, RESISTANT TO OIL-MIST MIXED AIR AND INERT FLUIDS.
 REINFORCEMENT : HIGH TENSILE STEEL WIRE.
 COVER : ABRASION, OZONE AND WEATHER RESISTANT PIN PRICKED SYNTHETIC RUBBER.
 APPLICATION : FOR HIGH PRESSURE AIR TRANSFER IN MINES.



SEELE : SYNTHETISCHER NBR GUMMI, RESISTENT GEGEN ÖLNEBEL- LUFT GEMISCHE SOWIE NEUTRALE FLÜSSIGKEITEN.
 EINLAGE : HOCHZUGFESTE STAHLDRAHTEINLAGE.
 DECKE : ABRIB- OZON UND WETTERBESTÄNDIGER SYNTHETISCHER GUMMI, GEPRICKT.
 ANWENDUNG : FÜR HOCHDRUCKLUFT ANWENDUNGEN IN MINEN.



SOTTOSTRATO : GOMMA NBR RESISTENTE AL PASSAGGIO D'ARIA CON OLIO NEBULIZZATO E FLUIDI INERTI.
 RINFORZO : IN ACCIAIO AD ALTA CARICO.
 COPERTURA : GOMMA SINTETICA MICRO-FORATA RESISTENTE ALL'ABRASIONE, ALL'OZONO ED AGLI AGENTI ATMOSFERICI.
 IMPIEGO : MANDATA D'ARIA AD ALTA PRESSIONE NELLE MINIERE.



TUBE : CAOUTCHOUC NBR RESISTANT AU BROUILLARD D'HUILES ET AUX FLUIDES INERTES.
 RENFORCEMENT : NAPPE EN ACIER A HAUTE TENACITE.
 REVETEMENT : CAOUTCHOUC SYNTHETIQUE MICROPERFORE RESISTANT A L'ABRASION, A L'OZONE ET AUX AGENTS ATMOSPHERIQUES.
 APPLICATION : POUR LE TRANSFERT D'AIR COMPRIE A HAUTE PRESSION DANS LES MINES.

ID		OD	WP		BP		W	L
inch	mm	mm	bar	psi	bar	psi	g/m	m
1/2"	12.7	23	40	580	160	2320	511	40-61
3/4"	19	29.5	40	580	160	2320	630	40-61
1"	25.4	36	40	580	160	2320	880	40-61
1 1/4"	32	43	40	580	160	2320	1110	40-61
1 1/2"	38	50	40	580	160	2320	1540	40-61
2"	50.8	66	40	580	160	2320	2515	40-61
2 1/2"	63.5	80	40	580	160	2320	3360	40-61
3"	76.2	94	40	580	160	2320	4500	40-61
4"	101.6	122	40	580	160	2320	6771	40-61

OPTIONS / OPTIONEN / OPZIONI / OPTIONS

- FLAME RESISTANCE : (U.S. MSHA APPROVED)
- HITZEBESTÄNDIGKEIT : (U.S. MSHA BESTÄTIGT)
- RESISTENZA ALLA FIAMMA : (U.S. MSHA CERTIFICATO)
- RESISTANCE A LA FLAMME : (U.S. MSHA CERTIFICATION)



-40°C / + 70°C
 -40°F / +158°F

MARKING / BESCHRIFTUNG / MARCATURA / MARQUAGE: **EMBOSSED OR TRANSFER TAPE**



NORMS NORMEN NORME NORMES	ISO 1307	COLOUR FARBEN COLORI COULEUR	
------------------------------------	----------	---------------------------------------	--



Dust and Air Suction



TUBE : NATURAL AND SYNTHETIC RUBBER.
 REINFORCEMENT : SYNTHETIC TEXTILE AND STEEL HELIX WIRE.
 COVER : ABRASION, OZONE, WEATHER AND HEAT RESISTANT SYNTHETIC RUBBER-CORRUGATED.
 APPLICATION : FOR SUCTION AND DELIVERY OF AIR,DUST,GRAIN, POWDER ETC.



SEELE : NATUR UND SYNTHETISCHER GUMMI.
 EINLAGE : SYNTHETISCHE TEXTILEINLAGE MIT STAHLDRAHTSPIRALE.
 DECKE : ABRIEB- OZON UND WETTERBESTÄNDIGER SYNTHETISCHER GUMMI, GEWELLT.
 ANWENDUNG : SAUG - DRUCKSCHLAUCH ZUM BEFÖRDERN VON LUFT, KÖRNERN UND PULVER.



SOTTOSTRATO : GOMMA NATURALE E SINTETICA.
 RINFORZO : INSERZIONI TESSILI E SPIRALE D'ACCIAIO INCORPORATA.
 COPERTURA : GOMMA SINTETICA RESISTENTE ALL'ABRASIONE, ALL'OZONO, AL CALORE ED AGLI AGENTI ATMOSFERICI-ONDULATO.
 IMPIEGO : ASPIRAZIONE D'ARIA, FUMI E POLVERI, ETC.



TUBE : CAOUTCHOUC NATUREL ET SYNTHETIQUE.
 RENFORCEMENT : INSERTION TEXTILE HAUTE TENACITE ET SPIRALE EN ACIER NOYEE.
 REVETEMENT : CAOUTCHOUC SYNTHETIQUE RESISTANT A L'ABRASION, A LA CHALEUR, A L'OZONE ET AUX AGENTS ATMOSPHERIQUES. - ONDULE.
 APPLICATION : POUR ASPIRATION ET REFOULEMENT D'AIR, DE POUSSIERE, DE GRAINS ET DE POUVRE ETC.

ID		OD	VACUUM	BR/r	W	L
inch	mm	mm	bar	mm	g/m	m
1"	25.4	32	-0.60	40	417	1-46
1 1/4"	32	39	-0.60	60	617	1-46
1 1/2"	38	45	-0.60	75	721	1-46
1 3/4"	44.5	52	-0.60	90	806	1-46
2"	50.8	58	-0.60	100	912	1-46
2 1/2"	63.5	72	-0.60	125	1407	1-46
3"	76.2	84.5	-0.60	150	1694	1-46
4"	101.6	110	-0.60	200	2336	1-46
5"	127	135	-0.60	295	3176	1-46
6"	152.4	162	-0.60	380	4171	1-46
8"	203.2	214	-0.60	700	6282	20
10"	254	267	-0.60	1000	8795	20
12"	305	319	-0.60	1400	10430	10



-20°C / + 70°C
 -40°F / +158°F

MARKING / BESCHRIFTUNG / MARCATURA / MARQUAGE: **EMBOSSED OR TRANSFER TAPE**



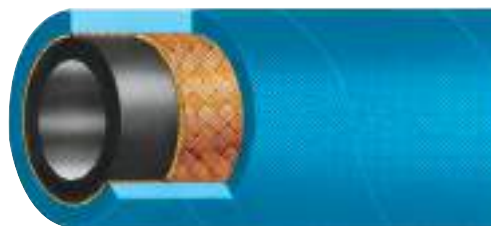

NORMS NORMEN NORME NORMES	ISO 1307	COLOUR FARBEN COLORI COULEUR	
------------------------------------	----------	---------------------------------------	--

1 Steel Wire Braid - High Temperature +135 °C



 TUBE : HIGH TEMPERATURE HYDRAULIC OIL RESISTANT SPECIAL SYNTHETIC RUBBER.
 REINFORCEMENT : 1 HIGH TENSILE STEEL WIRE BRAID.
 COVER : OIL, ABRASION AND WEATHER RESISTANT SPECIAL SYNTHETIC RUBBER.
 APPLICATION : FOR LOW-MEDIUM PRESSURE HYDRAULIC SYSTEMS IN INDUSTRY, COMPRESSORS AND MINING WHERE OPERATING TEMPERATURES ARE UP TO 150 °C

 SEELE : SPEZIELLES, SYNTETHISCHES GUMMI, BESTÄNDIG GEGEN HYDRAULIKÖLE MIT HOHEN ANWENDUNGSTEMPERATUREN
 EINLAGE : 1 GEFLECHTEINLAGE AUS HOCHZUGFESTEM STAHLDRAHT
 DECKE : SPEZIELLES, SYNTETHISCHES GUMMI, ÖL-, ABRIEB- UND WITTERUNGSBESTÄNDIG
 ANWENDUNG : GEEIGNET ALS NIEDER-UND MITTELDRUCK HYDRAULIKSCHLAUCH IN DER INDUSTRIE, KOMPRESSOREN UND BERGBAU. EINSATZFÄHIG BIS ZU 150 °C BETRIEBSTEMPERATUR

 SOTTOSTRATO : GOMMA SPECIALE SINTETICA RESISTENTE AI FLUIDI IDRAULICI AD ALTA TEMPERATURA.
 RINFORZO : 1 TRECCIA IN ACCIAIO AD ALTA TENACITÀ
 COPERTURA : GOMMA SPECIALE SINTETICA CON IMPRESSIONE TELA, RESISTENTE AGLI OLI, ABROSIONE ED AGENTI ATMOSFERICI.
 IMPIEGO : PER SISTEMI A PRESSIONE BASSA-MEDIA CHE IMPIEGANO FLUIDI IDRAULICI IN INDUSTRIA, COMPRESSORI MINERARIA AD ALTA TEMPERATURA FINO A 150 °C

 TUBE : CAOUTCHOUC SYNTHETIQUE SPECIAL RESISTANT AUX HUILES HYDRAULIQUES A HAUTE TEMPERATURE.
 RENFORCEMENT : 1 TRESSE D'ACIER TRES RESISTANTE
 REVETEMENT : CAOUTCHOUC SYNTHETIQUE SPECIAL RESISTANT A L'ABRASION, AUX HUILES, CARBURANTS ET AGENTS ATMOSPHERIQUES.
 APPLICATION : POUR LES SYSTEMES HYDRAULIQUES A BASSE ET MOYENNE PRESSION DANS L'INDUSTRIE, COMPRESSEURS, L'EXPLOITATION MINIÈRE OÙ ON EXIGE UNE TEMPERATURE JUSQU'A 150 °C

Dash Size	ID		ROD	OD	WP		BP		VACUUM	BR/r	W	L
	inch	mm	mm	mm	bar	psi	bar	psi	bar	mm	g/m	m
-03	3/16"	4.8	9.6	11.6	250	3625	1100	15950	- 0.80	90	190	>10
-04	1/4"	6.4	11.1	13.2	225	3263	1030	14935	- 0.80	100	235	>10
-05	5/16"	8	12.6	14.8	215	3118	970	14065	- 0.80	115	275	>10
-06	3/8"	9.5	15	17.2	180	2610	820	11890	- 0.80	130	350	>10
-08	1/2"	12.7	18.1	20.4	160	2320	700	10150	- 0.80	180	435	>10
-10	5/8"	16	21.2	23.5	130	1885	600	8700	- 0.80	200	500	>10
-12	3/4"	19	25.2	27.5	105	1523	500	7250	- 0.80	240	635	>10
-16	1"	25.4	33.1	35.4	88	1276	385	5583	- 0.80	300	935	>10
-20	1 1/4"	31.8	40.2	43.5	63	914	280	4060	- 0.60	420	1310	max. 46
-24	1 1/2"	38.1	46.7	50	50	725	260	3770	- 0.60	500	1485	max. 46
-32	2"	50.8	60.2	63.6	40	580	250	3625	- 0.60	630	2020	max. 46
-40	2 1/2"	63.5	73	76.5	40	580	200	2900	- 0.60	760	2670	max. 46
-48	3"	76.2	85	88.5	35	508	160	2320	- 0.60	900	2865	max. 46

OPTIONS / OPTIONEN / OPZIONI / OPTIONS



-50°C / +135°C (+150°C DISCONTINUOUS)
 -58°F / +275°F (+302°F DISCONTINUOUS)

MARKING / BESCHRIFTUNG / MARCATURA / MARQUAGE: **TRANSFER TAPE, EMBOSSED OR INK JET**

SEL **ULTIMATE** TS 6387/EN 853 1SN (**)(DN ** mm) Max. W.P. *** Bar / **** PSI 135 °C

NORMS
 NORMEN
 NORME
 NORMES
 DIN EN 853 1 SN
 TS 6387 EN 853 1 SN
 SAE 100 R1 AT - R1 AT Type S / ISO 1436: 2009
 ISO 1307

COLOUR
 FARBEN
 COLORI
 COULEUR



2 Steel Wire Braid - High Temperature

+135 °C



TUBE : HIGH TEMPERATURE HYDRAULIC OIL RESISTANT SPECIAL SYNTHETIC RUBBER.
 REINFORCEMENT : 2 HIGH TENSILE STEEL WIRE BRAID.
 COVER : OIL, ABRASION AND WEATHER RESISTANT SPECIAL SYNTHETIC RUBBER.
 APPLICATION : FOR MEDIUM-HIGH PRESSURE HYDRAULIC SYSTEMS IN INDUSTRY, COMPRESSORS AND MINING WHERE OPERATING TEMPERATURES ARE UP TO 150 °C



SEELE : SPEZIELLES, SYNTETHISCHES GUMMI, BESTÄNDIG GEGEN HYDRAULIKÖLE MIT HOHEN ANWENDUNGSTEMPERATUREN
 EINLAGE : 2 GEFLECHTSEINLAGEN AUS HOCHZUGFESTEM STAHLDRAHT
 DECKE : SPEZIELLES, SYNTETHISCHES GUMMI, ÖL-, ABRIEB- UND WITTERUNGSBESTÄNDIG
 ANWENDUNG : GEEIGNET ALS MITTEL- UND HOCHDRUCK HYDRAULIKSCHLAUCH IN DER INDUSTRIE, KOMPRESSOREN UND BERGBAU. EINSATZFÄHIG BIS ZU 150 °C BETRIEBSTEMPERATUR



SOTTOSTRATO : GOMMA SPECIALE SINTETICA RESISTENTE AI FLUIDI IDRAULICI AD ALTA TEMPERATURA.
 RINFORZO : 2 TRECCE IN ACCIAIO AD ALTA TENACITÀ.
 COPERTURA : GOMMA SPECIALE SINTETICA CON IMPRESSIONE TELA, RESISTENTE AGLI OLI, ABRASIONE ED AGENTI ATMOSFERICI.
 IMPIEGO : PER SISTEMI A PRESSIONE MEDIA-ALTA CHE IMPIEGANO FLUIDI IDRAULICI IN INDUSTRIA, COMPRESSORI MINERARIA AD ALTA TEMPERATURA FINO A 150 °C



TUBE : CAOUTCHOUC SYNTHETIQUE SPECIAL RESISTANT AUX HUILES HYDRAULIQUES A HAUTE TEMPERATURE.
 RENFORCEMENT : 2 TRESSERES D'ACIER TRES RESISTANTES.
 REVETEMENT : CAOUTCHOUC SYNTHETIQUE SPECIAL RESISTANT A L'ABRASION, AUX HUILES, CARBURANTS ET AGENTS ATMOSPHERIQUES.
 APPLICATION : POUR LES SYSTEMES HYDRAULIQUES A MOYENNE ET HAUTE PRESSION DANS L'INDUSTRIE, COMPRESSEURS, L'EXPLOITATION MINIERE OÙ ON EXIGE UNE TEMPERATURE JUSQU'A 150 °C

Dash Size	ID		ROD	OD	WP		BP		VACUUM	BR/r	W	L
	inch	mm	mm	mm	bar	psi	bar	psi	bar	mm	g/m	m
-03	3/16"	4.8	11.1	13.3	415	6018	1850	26825	- 0.95	90	305	>10
-04	1/4"	6.4	12.8	15	400	5800	1700	24650	- 0.95	100	390	>10
-05	5/16"	8	14.3	16.5	350	5075	1550	22475	- 0.95	115	455	>10
-06	3/8"	9.5	16.7	18.9	330	4785	1450	21025	- 0.95	130	560	>10
-08	1/2"	12.7	19.8	22.2	275	3988	1300	18850	- 0.95	180	665	>10
-10	5/8"	16	22.9	25.2	250	3625	1050	15225	- 0.95	200	780	>10
-12	3/4"	19	26.9	29.2	215	3118	920	13340	- 0.80	240	965	>10
-16	1"	25.4	34.8	37.2	165	2393	690	10005	- 0.80	300	1390	>10
-20	1 1/4"	31.8	44.3	47.3	125	1813	620	8990	- 0.80	420	2075	max. 46
-24	1 1/2"	38.1	50.7	53.7	90	1305	520	7540	- 0.80	500	2390	max. 46
-32	2"	50.8	63.5	66.7	78	1131	420	6090	- 0.80	630	3065	max. 46
-40	2 1/2"	63.5	75.2	79.8	69	1000	300	4350	- 0.60	760	3980	max. 46
-48	3"	76.2	87.4	91.9	50	725	240	3480	- 0.60	900	4165	max. 46

OPTIONS / OPTIONEN / OPZIONI / OPTIONS



-50 °C / +135 °C (+150 °C DISCONTINUOUS)
 -58 °F / +275 °F (+302 °F DISCONTINUOUS)

MARKING / BESCHRIFTUNG / MARCATURA / MARQUAGE: **TRANSFER TAPE, EMBOSSED OR INK JET**

SEL **ULTIMATE** TS 6387/EN 853 2SN (**)(DN ** mm) Max. W.P. *** Bar / **** PSI 135°C

NORMS NORMEN NORME NORMES	DIN EN 853 2 SN TS 6387 EN 853 2 SN SAE 100 R2 AT - R2 AT Type S / ISO 1436: 2009 ISO 1307	COLOUR FARBEN COLORI COULEUR	
------------------------------------	---	---------------------------------------	--

1 Steel Wire Braid - High Temperature +135 °C



TUBE : HIGH TEMPERATURE HYDRAULIC OIL RESISTANT SPECIAL SYNTHETIC RUBBER.
 REINFORCEMENT : SYNTHETIC TEXTILE AND 1 HIGH TENSILE STEEL WIRE BRAID.
 COVER : OIL AND WEATHER RESISTANT SYNTHETIC RUBBER IMPREGNATED SYNTHETIC BRAID.
 APPLICATION : FOR LOW-MEDIUM PRESSURE HYDRAULIC SYSTEMS IN INDUSTRY, COMPRESSORS AND MINING WHERE OPERATING TEMPERATURES ARE UP TO 150 °C



SEELE : SPEZIELLES, SYNTETHISCHES GUMMI, BESTÄNDIG GEGEN HYDRAULIKÖLE MIT HOHEN ANWENDUNGSTEMPERATUREN
 EINLAGE : 1 GEFLECHTEINLAGE AUS HOCHZUGFESTEM STAHLDRAHT MIT ZUSÄTZLICHER TEXTILEINLAGE
 DECKE : SPEZIELLES, SYNTETHISCHES GUMMI, ÖL-, ABRIB- UND WITTERUNGSBESTÄNDIG
 ANWENDUNG : GEEIGNET ALS NIEDER- UND MITTELDRUCK HYDRAULISCHLAUCH IN DER INDUSTRIE, KOMPRESSOREN UND BERGBAU. EINSATZFÄHIG BIS ZU 150 °C BETRIEBSTEMPERATUR



SOTTOSTRATO : GOMMA SPECIALE SINTETICA RESISTENTE AI FLUIDI IDRAULICI.
 RINFORZO : INSERZIONI TESSILI E 1 TRECCIA IN ACCIAIO AD ALTA TENACITÀ.
 COPERTURA : TRECCIA IN TESSILE IMPREGNATO DI GOMMA SINTETICA RESISTENTE AGLI OLI ED AGENTI ATMOSFERICI.
 IMPIEGO : PER SISTEMI A PRESSIONE BASSA-MEDIA CHE IMPIEGANO FLUIDI IDRAULICI IN INDUSTRIA, COMPRESSORI MINERARIA AD ALTA TEMPERATURA FINO A 150 °C



TUBE : CAOUTCHOUC SYNTHETIQUE SPECIAL RESISTANT AUX HUILES HYDRAULIQUES.
 RENFORCEMENT : INSERTION TEXTILE ET 1 TRESSE D'ACIER TRES RESISTANTE.
 REVETEMENT : TRESSE TEXTILE IMPREGNEE DE CAOUTCHOUC SYNTHETIQUE SPECIAL RESISTANT A L'ABRASION, AUX HUILES, CARBURANTS ET AGENTS ATMOSPHERIQUES.
 APPLICATION : POUR LES SYSTEMES HYDRAULIQUES A BASSE ET MOYENNE PRESSION DANS L'INDUSTRIE, COMPRESSEURS, L'EXPLOITATION MINIERE OÙ ON EXIGE UNE TEMPERATURE JUSQU'A 150 °C

Dash Size	ID		OD	WP		BP		BR/r	W	L
	inch	mm	mm	bar	psi	bar	psi	mm	g/m	m
-04	3/16"	4.8	12.9	210	3045	1100	15950	75	255	>10
-05	1/4"	6.4	14.5	210	3045	1000	14500	85	295	>10
-06	5/16"	8	16.8	157	2277	800	11600	100	370	>10
-08	13/32"	10.3	19.1	140	2030	700	10150	115	430	>10
-10	1/2"	12.7	22.9	122	1769	600	8700	140	590	>10
-12	5/8"	16	27.1	105	1523	520	7540	165	735	>10
-16	7/8"	22.2	30.8	56	812	380	5510	185	725	>10
-20	1 1/8"	28.6	37.6	43	624	300	4350	230	945	>10
-24	1 3/8"	34.9	44.5	35	508	250	3625	265	1170	max. 46
-32	1 13/16"	46	56.4	24	348	200	2900	335	1420	max. 46
-40	2 3/8"	60	73	24	348	150	2175	610	2355	max. 46
-48	3"	76.2	90.5	14	203	100	1450	840	3195	max. 46

OPTIONS / OPTIONEN / OPZIONI / OPTIONS

CERTIFICATE
 ZERTIFIZIERT
 CERTIFICATO
 CERTIFICAT

D.O.T



-50 °C / +135 °C (+150 °C DISCONTINUOUS)
 -58 °F / +275 °F (+302 °F DISCONTINUOUS)

MARKING / BESCHRIFTUNG / MARCATURA / MARQUAGE: **TRANSFER TAPE OR INK JET**

SEL **ULTIMATE** SAE 100 R5 (***) (DN ** mm) Max. W.P. *** Bar / **** PSI 135 °C

NORMS NORMEN NORME NORMES	SAE 100 R5 ISO 1307	COLOUR FARBEN COLORI COULEUR	
------------------------------------	------------------------	---------------------------------------	--



1 Textile Braid - High Temperature

+135 °C

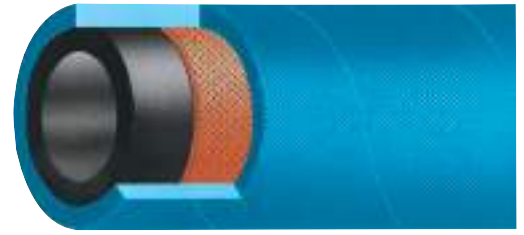

TUBE : HIGH TEMPERATURE HYDRAULIC OIL RESISTANT SPECIAL SYNTHETIC RUBBER.
 REINFORCEMENT : 1 HIGH TENSILE SYNTHETIC TEXTILE BRAID.
 COVER : OIL, ABRASION AND WEATHER RESISTANT SPECIAL SYNTHETIC RUBBER.
 APPLICATION : FOR HYDRAULIC CONTROL LINES, DISCHARGE UNDER LOW PRESSURE OF HYDRAULIC FLUIDS, AIR AND WATER, WHERE OPERATING TEMPERATURES ARE UP TO 150 °C.



SEELE : SPEZIELLES, SYNTETHISCHES GUMMI, BESTÄNDIG GEGEN HYDRAULIKÖLE MIT HOHEN ANWENDUNGSTEMPERATUREN
 EINLAGE : 1 HOCHZUGFESTE EINLAGE AUS TEXTILGEFLECHT
 DECKE : SPEZIELLES, SYNTETHISCHES GUMMI, ÖL-, ABRIEB- UND WITTERUNGSBESTÄNDIG
 ANWENDUNG : GEEIGNET ALS NIEDERDRUCK HYDRAULIKSCHLAUCH ZUM ENTLADEN VON HYDRAULIKÖL, WASSER UND LUFT. EINSATZFÄHIG BIS ZU 150 °C BETRIEBSTEMPERATUR



SOTTOSTRATO : GOMMA SPECIALE SINTETICA RESISTENTE AI FLUIDI IDRAULICI AD ALTA TEMPERATURA.
 RINFORZO : 1 TRECCIA TESSILE AD ALTA TENACITÀ.
 COPERTURA : GOMMA SPECIALE SINTETICA RESISTENTE AGLI OLI, ABRASIONE ED AGENTI ATMOSFERICI.
 IMPIEGO : PER PASSAGGIO A BASSA PRESSIONE DEI FLUIDI IDRAULICI A BASE DI OLI MINERALI, ACQUA ED ARIA COMPRESSA, AD ALTA TEMPERATURA FINO A 150 °C.



TUBE : CAOUTCHOUC SPECIAL SYNTHETIQUE RESISTANT AUX HUILES HYDRAULIQUES A HAUTE TEMPERATURE.
 RENFORCEMENT : 1 TRESSE TEXTILE TRES RESISTANTE.
 REVETEMENT : CAOUTCHOUC SPECIAL SYNTHETIQUE RESISTANT A L'ABRASION, AUX HUILES, CARBURANTS ET AGENTS ATMOSPHERIQUES.
 APPLICATION : POUR LE PASSAGE A BASSE PRESSION DES HUILES HYDRAULIQUES, D' HUILES MINERALES, EAU, AIR OU ON EXIGE UNE TEMPERATURE JUSQU'A 150 °C.

Dash Size	ID		OD	WP		BP		BR/r	W	L
	inch	mm	mm	bar	psi	bar	psi	mm	g/m	m
-03	3/16"	4.8	10.7	34	493	250	3625	35	100	>10
-04	1/4"	6.4	12.3	28	406	200	2900	45	120	>10
-05	5/16"	8	13.9	28	406	200	2900	65	140	>10
-06	3/8"	9.5	15.5	28	406	200	2900	75	165	>10
-08	1/2"	12.7	19.5	28	406	200	2900	90	245	>10
-10	5/8"	16	22.6	24	348	140	2030	115	290	>10
-12	3/4"	19	25.8	21	305	130	1885	140	345	>10
-16	1"	25.4	33.2	20	290	100	1450	150	505	>10



-40°C / +135°C (+150°C DISCONTINUOUS)
 -40°F / +275°F (+302°F DISCONTINUOUS)



MARKING / BESCHRIFTUNG / MARCATURA / MARQUAGE: **TRANSFER TAPE, EMBOSSED OR INK JET**

SEL **ULTIMATE** TS 6388/EN 854 R6 (***) (DN ** mm) Max. W.P. *** Bar / **** PSI 135°C

NORMS	SAE 100 R6	COLOUR	
NORMEN	EN 854 TYPE R6	FARBEN	
NORME	TS 6388 EN 854 TIP R6	COLORI	
NORMES	ISO 4079-1 R6 ISO 1307	COULEUR	

Nitrogen Hose



 TUBE : NITROGEN RESISTANT NATURAL AND SYNTHETIC RUBBER.
 REINFORCEMENT : HIGH TENSILE SYNTHETIC TEXTILE.
 COVER : ABRASION, OZONE AND WEATHER RESISTANT SYNTHETIC RUBBER.
 APPLICATION : FOR TRANSFER OF NITROGEN.

 SEELE : NATUR- UND SYNTHETISCHER KAUSCHUK, BESTÄNDIG GEGEN STICKSTOFF.
 EINLAGE : HOCHZUGFESTE TEXTILEINLAGE.
 DECKE : ABRIEB-, OZON- WETTERBESTÄNDIGER, SYNTHETISCHER GUMMI.
 ANWENDUNG : ZUM BEFÖRDERN VON STICKSTOFF.

 SOTTOSTRATO : GOMMA NATURALE E SINTETICA RESISTENTE ALL'AZOTO.
 RINFORZO : INSERZIONI TESSILI AD ALTA TENACITÀ.
 COPERTURA : GOMMA SINTETICA RESISTENTE ALL'ABRASIONE, ALL'OZONO ED AGLI AGENTI ATMOSFERICI.
 IMPIEGO : PER IL TRASFERIMENTO D'AZOTO.

 TUBE : CAOUTCHOUC NATUREL ET SYNTHETIQUE, RESISTANT A L'AZOTE.
 RENFORCEMENT : INSERTION TEXTILE HAUTE TENACITE.
 REVETEMENT : CAOUTCHOUC SYNTHETIQUE, RESISTANT A L'ABRASION, A L'OZONE, ET AUX AGENTS ATMOSPHERIQUES..
 APPLICATION : POUR LE TRANSFERT DE L'AZOTE.

ID		OD	WP		BP		W	L
inch	mm	mm	bar	psi	bar	psi	g/m	m
1/2"	12.7	22	20	290	64	928	332	40-46-61
5/8"	16	25	20	290	64	928	374	40-46-61
3/4"	19	29	20	290	64	928	504	40-46-61
1"	25.4	36	20	290	64	928	670	40-46-61
1 1/4"	32	44	20	290	64	928	955	40-46-61
1 1/2"	38	51	20	290	64	928	1177	40-46-61
1 3/4"	44.5	60	20	290	64	928	1630	40-46-61
2"	50.8	65	20	290	64	928	1655	40-46-61
2 1/2"	63.5	80	20	290	64	928	2450	40-46-61
3"	76.2	92	20	290	64	928	2650	40-46-61
4"	101.6	118	20	290	64	928	3810	40-46-61

 -40°C / + 70°C
 -40°F / +158°F

MARKING / BESCHRIFTUNG / MARCATURA / MARQUAGE: **EMBOSSED OR TRANSFER TAPE**

 **NITRO-20** **NITROGEN HOSE - W.P. 20 Bar (290 PSI)** 

NORMS NORMEN NORME NORMES	ISO 1307	COLOUR FARBEN COLORI COULEUR	
------------------------------------	----------	---------------------------------------	--

Welding
Schweißen
Saldatura
Soudure



Welding (Oxygen - Acetylene)



TUBE : BLACK SMOOTH SYNTHETIC RUBBER, RESISTANT TO OXYGEN AND ACETYLENE.
 REINFORCEMENT : HIGH TENSILE SYNTHETIC TEXTILE.
 COVER : ABRASION, WEATHER AND FLAME RESISTANT SPECIAL SYNTHETIC RUBBER.
 APPLICATION : FOR INDUSTRIAL WELDING WITH OXYGEN OR ACETYLENE.



SEELE : SCHWARZER, GLATTER SYNTHETISCHER GUMMI; BESTÄNDIG GEGEN SAUERSTOFF UND ACETYLEN GASE
 EINLAGE : HOCHZUGFESTE SYNTHETISCHE TEXTILEINLAGE
 DECKE : ABRIB- UND WETTERBESTÄNDIGER, SPEZIELLER SYNTHETISCHER GUMMI, FLAMMWIDRIG
 ANWENDUNG : FÜR INDUSTRIELLE SCHWEIßARBEITEN MIT SAUERSTOFF UND ACETYLEN



SOTTOSTRATO : NERO.LISCIO IN GOMMA SINTETICA RESISTENTE ALL'AZIONE DEI GAS DI SALDATURA.
 RINFORZO : INSERZIONI TESSILI AD ALTA TENACITÀ.
 COPERTURA : GOMMA SPECIALE SINTETICA RESISTENTE ALL'ABRASIONE, ALLA FIAMMA ED AGLI AGENTI ATMOSFERICI.
 IMPIEGO : PER LA SALDATURA INDUSTRIALE CON OSSIGENO E ACETILENE.



TUBE : CAOUTCHOUC SYNTHETIQUE LISSE, NOIR, RESISTANT A L'OXYGENE ET ACETYLENE.
 RENFORCEMENT : INSERTION TEXTILE HAUTE TENACITE.
 REVETEMENT : CAOUTCHOUC SPECIAL SYNTHETIQUE RESISTANT A L'ABRASION, AUX AGENTS ATMOSPHERIQUES ET A LA FLAMME.
 APPLICATION : POUR LE SOUDAGE A OXYACETYLENIQUE.

ID		OD	WP		BP		BR/r	W	L
inch	mm	mm	bar	psi	bar	psi	mm	g/m	m
1/4"	6	13	20	290	60	870	30	155	100
1/4"	6	14	20	290	60	870	30	180	100
5/16"	8	15	20	290	60	870	40	185	100
5/16"	8	16	20	290	60	870	40	220	100
23/64"	9	16	20	290	60	870	45	200	100
3/8"	10	17	20	290	60	870	50	220	100
3/8"	10	18	20	290	60	870	50	255	100
1/2"	13	22	20	290	60	870	65	370	100



-30°C / + 80°C
 -22°F / +176°F



MARKING / BESCHRIFTUNG / MARCATURA / MARQUAGE: **EMBOSSED OR INK JET**

SEL JUPITER ACETYLENE ISO 3821 2 MPa (20 BAR) (mm) (YEAR) <TSE>**

SEL JUPITER OXYGEN ISO 3821 2 MPa (20 BAR) (mm) (YEAR) <TSE>**

NORMS NORMEN NORME NORMES	ISO 3821 ISO1307	COLOUR FARBEN COLORI COULEUR			
------------------------------------	---------------------	---------------------------------------	--	--	--

Welding (Oxygen and Acetylene)



TUBE : BLACK SMOOTH SYNTHETIC RUBBER RESISTANT TO OXYGEN AND ACETYLENE.
 REINFORCEMENT : HIGH TENSILE SYNTHETIC TEXTILE.
 COVER : ABRASION, WEATHER AND FLAME RESISTANT SPECIAL SYNTHETIC RUBBER.
 APPLICATION : FOR INDUSTRIAL WELDING WITH OXYGEN OR ACETYLENE.



SEELE : SCHWARZER, GLATTER SYNTHETISCHER GUMMI; BESTÄNDIG GEGEN SAUERSTOFF UND ACETYLEN GASE
 EINLAGE : HOCHZUGFESTE SYNTHETISCHE TEXTILEINLAGE
 DECKE : ABRIB- UND WETTERBESTÄNDIGER, SPEZIELLER SYNTHETISCHER GUMMI; FLAMMWIDRIG
 ANWENDUNG : FÜR INDUSTRIELLE SCHWEIßARBEITEN MIT SAUERSTOFF UND ACETYLEN



SOTTOSTRATO : NERO, LISCIO IN GOMMA SINTETICA RESISTENTE ALL'AZIONE DEI GAS DI SALDATURA.
 RINFORZO : INSERZIONI TESSILI AD ALTA TENACITÀ.
 COPERTURA : GOMMA SPECIALE SINTETICA RESISTENTE ALL'ABRASIONE, ALLA FIAMMA ED AGLI AGENTI ATMOSFERICI.
 IMPIEGO : PER LA SALDATURA INDUSTRIALE CON OSSIGENO E ACETILENE.



TUBE : CAOUTCHOUC SYNTHETIQUE LISSE, NOIR, RESISTANT A L'OXYGENE ET ACETYLENE.
 RENFORCEMENT : INSERTION TEXTILE HAUTE TENACITE.
 REVETEMENT : CAOUTCHOUC SPECIAL SYNTHETIQUE RESISTANT A L'ABRASION, AUX AGENTS ATMOSPHERIQUES ET A LA FLAMME.
 APPLICATION : POUR LE SOUDAGE A OXYACETYLENIQUE.

ID		OD	WP		BP		BR/r	W	L
inch	mm	mm	bar	psi	bar	psi	mm	g/m	m
3/16"	5	11	20	290	60	870	25	230	10-100
3/16"	5	11	20	290	60	870	25	230	10-100
1/4"	6	13	20	290	60	870	30	320	10-100
1/4"	6	13	20	290	60	870	30	320	10-100
1/4"	6	13	20	290	60	870	30	355	10-100
5/16"	8	15	20	290	60	870	30	355	10-100
5/16"	8	15	20	290	60	870	40	390	10-100
5/16"	8	15	20	290	60	870	40	390	10-100
5/16"	8	15	20	290	60	870	40	430	10-100
3/8"	10	17	20	290	60	870	40	430	10-100
3/8"	10	17	20	290	60	870	50	460	10-100
3/8"	10	17	20	290	60	870	50	460	10-100
3/8"	10	17	20	290	60	870	50	630	10-100
1/2"	13	22	20	290	60	870	50	630	10-100
1/2"	13	22	20	290	60	870	65	770	10-100
1/2"	13	22	20	290	60	870	65	770	10-100



-30°C / + 80°C
 -22°F / +176°F



MARKING / BESCHRIFTUNG / MARCATURA / MARQUAGE: **EMBOSSED OR INK JET**

SEL JUPITER TWIN OX-AC ISO 3821 2 MPa (20 BAR) (mm) (YEAR) <TSE>**

SEL JUPITER TWIN OX-AC ISO 3821 2 MPa (20 BAR) (mm) (YEAR) <TSE>**

NORMS NORMEN NORME NORMES	ISO 3821 ISO 1307	COLOUR FARBEN COLORI COULEUR	
------------------------------------	----------------------	---------------------------------------	--

Welding (Oxygen - Acetylene)

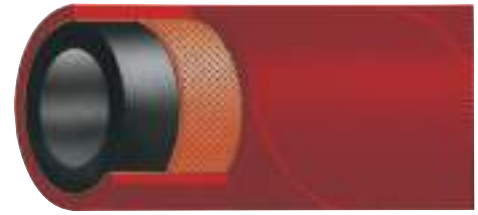

TUBE : BLACK SMOOTH SYNTHETIC RUBBER, RESISTANT TO OXYGEN AND ACETYLENE.
 REINFORCEMENT : HIGH TENSILE SYNTHETIC TEXTILE.
 COVER : ABRASION, WEATHER AND FLAME RESISTANT SPECIAL SYNTHETIC RUBBER.
 APPLICATION : FOR INDUSTRIAL WELDING WITH OXYGEN OR ACETYLENE.



SEELE : SCHWARZER, GLATTER SYNTHETISCHER GUMMI; BESTÄNDIG GEGEN SAUERSTOFF UND ACETYLEN GASE
 EINLAGE : HOCHZUGFESTE SYNTHETISCHE TEXTILEINLAGE
 DECKE : ABRIEB- UND WETTERBESTÄNDIGER, SPEZIELLER SYNTHETISCHER GUMMI; FLAMMWIDRIG
 ANWENDUNG : FÜR INDUSTRIELLE SCHWEIßARBEITEN MIT SAUERSTOFF UND ACETYLEN



SOTTOSTRATO : NERO, LISCIO IN GOMMA SINTETICA RESISTENTE ALL'AZIONE DEI GAS DI SALDATURA.
 RINFORZO : INSERZIONI TESSILI AD ALTA TENACITÀ.
 COPERTURA : GOMMA SPECIALE SINTETICA RESISTENTE ALL'ABRASIONE, ALLA FIAMMA ED AGLI AGENTI ATMOSFERICI.
 IMPIEGO : PER LA SALDATURA INDUSTRIALE CON OSSIGENO E ACETILENE.



TUBE : CAOUTCHOUC SYNTHETIQUE LISSE, NOIR. RESISTANT A L'OXYGENE ET ACETYLENE.
 RENFORCEMENT : INSERTION TEXTILE HAUTE TENACITE.
 REVETEMENT : CAOUTCHOUC SPECIAL SYNTHETIQUE RESISTANT A L'ABRASION, AUX AGENTS ATMOSPHERIQUES ET A LA FLAMME.
 APPLICATION : POUR LE SOUDAGE A OXYACETYLENIQUE.

ID		OD	WP		BP		BR/r	W	L
inch	mm	mm	bar	psi	bar	psi	mm	g/m	m
5/16"	8	16	25	363	75	1088	35	235	100
25/64"	9.9	19	25	363	75	1088	45	335	100
1/2"	12.7	23	25	363	75	1088	55	455	100
5/8"	16	26	25	363	75	1088	70	535	100
3/4"	19	32	25	363	75	1088	85	830	100
1"	25.4	38	25	363	75	1088	140	1045	100
1 1/4"	31.8	46	25	363	75	1088	160	1425	100
1 1/2"	38.1	54	25	363	75	1088	190	1850	100



-30°C / +100°C
 -22°F / +212°F

MARKING / BESCHRIFTUNG / MARCATURA / MARQUAGE: **EMBOSSED OR INK JET**

SEL JUPITER ACETYLENE ASTM C542 2.5 MPa (25 BAR) (mm) (YEAR)**

SEL JUPITER OXYGEN ASTM C542 2.5 MPa (25 BAR) (mm) (YEAR)**

NORMS NORMEN NORME NORMES	ASTM C 542 ISO 1307	COLOUR FARBEN COLORI COULEUR	
------------------------------------	------------------------	---------------------------------------	--

LPG Welding



TUBE : BLACK,LPG AND PROPANE RESISTANT SPECIAL SYNTHETIC RUBBER.
 REINFORCEMENT : HIGH TENSILE SYNTHETIC TEXTILE.
 COVER : ABRASION, FLAME,OZONE AND WEATHER RESISTANT SMOOTH SYNTHETIC RUBBER.
 APPLICATION : FOR WELDING WITH LPG.



SEELE : SCHWARZER, GLATTER SYNTHETISCHER GUMMI; BESTÄNDIG GEGEN LPG UND PROPAN GASE
 EINLAGE : HOCHZUGFESTE SYNTHETISCHE TEXTILEINLAGE
 DECKE : ABRIEB-, WETTER- UND OZONBESTÄNDIGER, SPEZIELLER SYNTHETISCHER GUMMI, FLAMMWIDRIG
 ANWENDUNG : FÜR INDUSTRIELLE SCHWEIßARBEITEN MIT SAUERSTOFF UND ACETYLEN



SOTTOSTRATO : NERO,LISCIO IN GOMMA SINTETICA RESISTENTE AL GPL E PROPANO
 RINFORZO : INSERZIONI TESSILI AD ALTA TENACITÀ.
 COPERTURA : GOMMA SPECIALE SINTETICA RESISTENTE ALL'ABRASIONE, ALLA FIAMMA, ALL'OZONO ED AGLI AGENTI ATMOSFERICI.
 IMPIEGO : PER LA SALDATURA E MANDATA DI GPL.



TUBE : CAOUTCHOUC SYNTHETIQUE NOIR. RESISTANT A GPL ET PROPANE.
 RENFORCEMENT : INSERTION TEXTILE HAUTE TENACITE.
 REVETEMENT : CAOUTCHOUC SYNTHETIQUE LISSE, RESISTANT A L'ABRASION, AUX AGENTS ATMOSPHERIQUES ET A LA FLAMME.
 APPLICATION : POUR LE SOUDAGE, GPL.

ID		OD	WP		BP		BR/r	W	L
inch	mm	mm	bar	psi	bar	psi	mm	g/m	m
1/4"	6	13	20	290	60	870	30	155	100
1/4"	6	14	20	290	60	870	30	185	100
5/16"	8	15	20	290	60	870	40	190	100
5/16"	8	16	20	290	60	870	40	225	100
23/64"	9	16	20	290	60	870	45	205	100
3/8"	10	17	20	290	60	870	50	220	100
3/8"	10	18	20	290	60	870	50	260	100
1/2"	13	22.5	20	290	60	870	65	400	100





-30°C / + 80°C
 -22°F / +176°F



MARKING / BESCHRIFTUNG / MARCATURA / MARQUAGE: **EMBOSED OR INK JET**

SEL URANUS - PROPANE ISO 3821 2 MPa (20 BAR) (mm) (YEAR) <TSE>**

NORMS NORMEN NORME NORMES	ISO 3821 ISO 1307	COLOUR FARBEN COLORI COULEUR	 
------------------------------------	----------------------	---------------------------------------	---

Welding Torch Hose

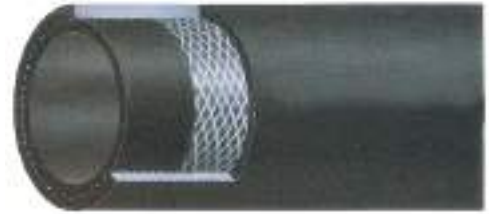

TUBE : NON CONDUCTIVE SPECIAL SYNTHETIC RUBBER.
 REINFORCEMENT : HIGH TENSILE SYNTHETIC TEXTILE.
 COVER : ABRASION, HEAT, OZONE AND WEATHER RESISTANT NON CONDUCTIVE SMOOTH SPECIAL SYNTHETIC RUBBER.
 APPLICATION : DELIVERY OF WATER AND COOLING LIQUIDS SUITABLE FOR WELDING TORCHS.



SEELE : SYNTHETISCHES-GUMMI, ISOLIEREND.
 EINLAGE : HOCHZUGFESTE SYNTHETISCHE TEXTILEINLAGE
 DECKE : ABRIEBFEST, HITZE-, OZON- UND WITTERUNGSBESTÄNDIG, SYNTHETISCHES-GUMMI, ISOLIEREND, GLATT.
 ANWENDUNG : GEEINGNET FÜR WASSERZUFÜHRUNG UND KÜHLUNG BEI ELEKTRISCHEN SCHWEISSMASCHINEN.



SOTTOSTRATO : GOMMA SPECIALE SINTETICA, NON CONDUTTIVA.
 RINFORZO : INSERZIONI TESSILI AD ALTA TENACITÀ.
 COPERTURA : GOMMA SPECIALE SINTETICA, NON CONDUTTIVA, LISCIA, RESISTENTE ALL'ABRASIONE, AL CALORE, ALL'OZONO ED AGLI AGENTI ATMOSFERICI.
 IMPIEGO : PER MANDATA DI ACQUA E LIQUIDI DI RAFFREDDAMENTO IMPIEGATO PER LA COSTRUZIONE DI TORCE PER LA SALDATURA.



TUBE : CAOUTCHOUC SPECIAL SYNTHETIQUE NON-CONDUCTEUR.
 RENFORCEMENT : INSERTION TEXTILE HAUTE TENACITE.
 REVETEMENT : CAOUTCHOUC SPECIAL SYNTHETIQUE NON-CONDUCTEUR, LISSE, RESISTANT A L'ABRASION, A LA CHALEUR, A L'OZONE ET AUX AGENTS ATMOSPHERIQUES.
 APPLICATION : TRANSFER D'EAU ET LIQUIDES DE REFROIDISSEMENT APPROPRIE POUR LES TORCHES DE SOUDAGE.

ID		OD	WP		BP		W	L
inch	mm	mm	bar	psi	bar	psi	g/m	m
5/16"	8	13	7	102	21	305	115	100
23/64"	9	14	7	102	21	305	130	100
3/8"	10	15.5	7	102	21	305	155	100



-40°C / +100°C
 -40°F / +212°F

MARKING / BESCHRIFTUNG / MARCATURA / MARQUAGE: **EMBOSSED OR INK JET**

SEL TORCH L/L WELDING TORCH HOSE (*) (YEAR) <LOT>**

NORMS NORMEN NORME NORMES	ISO 1307	COLOUR FARBEN COLORI COULEUR	
------------------------------------	----------	---------------------------------------	--

Hot Water

Heisswasser

Acqua Calda

Eau Chaude

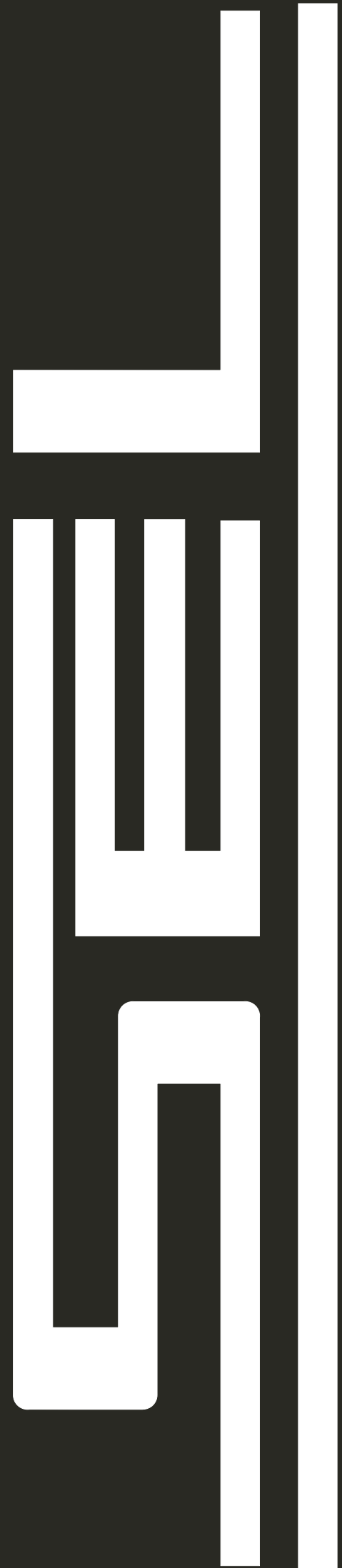

Car Heater - Radiator



 TUBE : EPDM RUBBER.
 REINFORCEMENT : HIGH TENSILE SYNTHETIC TEXTILE.
 COVER : ABRASION, HEAT, OZONE AND WEATHER RESISTANT, SMOOTH EPDM RUBBER.
 APPLICATION : FOR DELIVERY OF HOT WATER WITH VERY LIGHT CHEMICAL CONTENT IN INDUSTRIAL APPLICATIONS.

 SEELE : EPDM-GUMMI.
 EINLAGE : HOCHZUGFESTE SYNTHETISCHE TEXTILEINLAGE.
 DECKE : EPDM, ABRIEFEST, HITZE-, OZON- UND WITTERUNGSBESTÄNDIG, GLATT.
 ANWENDUNG : GEEIGNET ALS KÜHLERSCHLAUCH FÜR INDUSTRIE- UND AUTOMOBILBEREICH.

 SOTTOSTRATO : GOMMA IN EPDM.
 RINFORZO : INSERZIONI TESSILI AD ALTA TENACITÀ.
 COPERTURA : GOMMA IN EPDM LISCIA, RESISTENTE ALL'ABRASIONE, AL CALORE, ALL'OZONO ED AGLI AGENTI ATMOSFERICI.
 IMPIEGO : PER MANDATA D'ACQUA CALDA ANCHE CON CONTENUTI CHIMICI MOLTO LEGGERI NELL'INDUSTRIA.

 TUBE : CAOUTCHOUC EPDM.
 RENFORCEMENT : INSERTION TEXTILE HAUTE TENACITE.
 REVETEMENT : CAOUTCHOUC EPDM LISSE, RESISTANT A L'ABRASION, A LA CHALEUR, A L'OZONE ET AUX AGENTS ATMOSPHERIQUES.
 APPLICATION : POUR REFOULEMENT D'EAU CHAUDE MEME AVEC UN ADDITIF CHIMIQUE A FAIBLE CONCENTRATION, DANS L'INDUSTRIE.

ID		OD		WP		BP		W	L
inch	mm	mm	mm	bar	psi	bar	psi	g/m	m
1/4"	6	12	12	4	58	12	174	115	100
5/16"	8	14	14	4	58	12	174	140	100
3/8"	10	16	16	4	58	12	174	165	100
1/2"	13	20	20	4	58	12	174	260	100
5/8"	16	23	23	4	58	12	174	290	100
3/4"	19	27	27	4	58	12	174	390	100
1"	25	35	35	4	58	12	174	635	100

OPTIONS / OPTIONEN / OPZIONI / OPTIONS

Upon Request : DIN 73411 Type A/B - TS 548 Type 1/Type 2

Auf Anfrage : DIN 73411 Type A/B - TS 548 Type 1/Type 2

Su Richiesta : DIN 73411 Type A/B - TS 548 Type 1/Type 2

Sur Demande : DIN 73411 Type A/B - TS 548 Type 1/Type 2

 -40°C / +120°C
 -40°F / +248°F

MARKING / BESCHRIFTUNG / MARCATURA / MARQUAGE: **EMBOSSED OR INK JET**

SEL ISI L/L HOT WATER (*) (YEAR) <TSE>**

NORMS NORMEN NORME NORMES	ISO 1307	COLOUR FARBEN COLORI COULEUR	
------------------------------------	----------	---------------------------------------	--

Car Heater

LOW OIL RESISTANCE

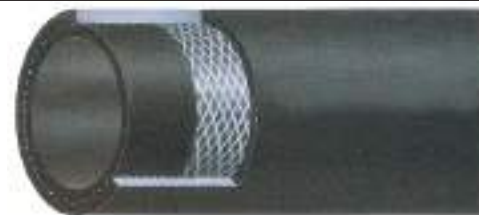

TUBE : EPDM RUBBER.
 REINFORCEMENT : HIGH TENSILE SYNTHETIC TEXTILE.
 COVER : ABRASION, HEAT, OZONE AND WEATHER RESISTANT, SMOOTH EPDM RUBBER.
 APPLICATION : FOR DELIVERY OF HOT WATER WITH VERY LIGHT CHEMICAL CONTENT IN INDUSTRIAL APPLICATIONS.



SEELE : EPDM-GUMMI.
 EINLAGE : HOCHZUGFESTE SYNTHETISCHE TEXTILEINLAGE.
 DECKE : EPDM, ABRIEBFEST, HITZE-, OZON- UND WITTERUNGSBESTÄNDIG, GLATT.
 ANWENDUNG : GEEIGNET ALS KÜHLERSCHLAUCH FÜR INDUSTRIE- UND AUTOMOBILBEREICH.



SOTTOSTRATO : GOMMA IN EPDM.
 RINFORZO : INSERZIONI TESSILI AD ALTA TENACITÀ.
 COPERTURA : GOMMA IN EPDM LISCIA, RESISTENTE ALL'ABRASIONE, AL CALORE, ALL'OZONO ED AGLI AGENTI ATMOSFERICI.
 IMPIEGO : PER MANDATA D'ACQUA CALDA ANCHE CON CONTENUTI CHIMICI MOLTO LEGGERI NELL'INDUSTRIA.



TUBE : CAOUTCHOUC EPDM.
 REINFORCEMENT : INSERTION TEXTILE HAUTE TENACITE.
 REVETEMENT : CAOUTCHOUC EPDM LISSE, RESISTANT A L'ABRASION, A LA CHALEUR, A L'OZONE ET AUX AGENTS ATMOSPHERIQUES.
 APPLICATION : POUR REFOULEMENT D'EAU CHAUDE MEME AVEC UN ADDITIF CHIMIQUE A FAIBLE CONCENTRATION, DANS L'INDUSTRIE.

ID		OD		WP		BP		BR/r	W	L
inch	mm	mm	mm	bar	psi	bar	psi	mm	g/m	m
3/8"	10	17	17	10	145	30	435	80	175	100
1/2"	13	20	20	10	145	30	435	105	215	100
5/8"	16	23	23	10	145	30	435	160	250	100
3/4"	19	28	28	10	145	30	435	190	390	100
1"	25	34	34	10	145	30	435	250	490	100



-40°C / +125°C
 -40°F / +257°F

MARKING / BESCHRIFTUNG / MARCATURA / MARQUAGE: **EMBOSSED OR INK JET**

SEL CAR HEATER HOSE SAE J20 R3 D1 (x ** mm) (QUARTER/YEAR) (LOT)**

SEL CAR HEATER HOSE SAE J20 R3 D2 (x ** mm) (QUARTER/YEAR) (LOT)**

NORMS NORMEN NORME NORMES	SAE J20 R3 D1 SAE J20 R3 D2 ISO 1307	COLOUR FARBEN COLORI COULEUR	
------------------------------------	--	---------------------------------------	--

Radiator



TUBE : HEAT AND ANTI-FREEZE LIQUIDS RESISTANT EPDM RUBBER.
 REINFORCEMENT : HIGH TENSILE SYNTHETIC TEXTILE.
 COVER : HEAT, AGEING AND WEATHER RESISTANT EPDM RUBBER.
 APPLICATION : FOR CONVEYING HOT WATER MIXED WITH ANTI-FREEZE LIQUIDS IN COOLING SYSTEMS, AUTOMOTIVE AND STATIONARY ENGINES.



SEELE : EPDM-GUMMI, HITZE- UND KÜHLMITTELBESTÄNDIG.
 EINLAGE : HOCHZUGFESTE SYNTHETISCHE TEXTILEINLAGE.
 DECKE : HITZE-, ALTERUNGS-, WITTERUNGSBESTÄNDIG, EPDM-GUMMI.
 ANWENDUNG : BESONDERS GEEIGNET ALS KÜHLERSCHLAUCH FÜR KRAFTFAHRZEUGE UND STATIONÄREN MOTOREN ZUR VERWENDUNG MIT FROSTSCHUTZMITTELN.



SOTTOSTRATO : GOMMA IN EPDM, RESISTENTE AI LIQUIDI ANTIGELO E AL CALORE.
 RINFORZO : INSERZIONI TESSILI AD ALTA TENACITÀ.
 COPERTURA : GOMMA IN EPDM RESISTENTE AL CALORE, ALL'INVECCHIAMENTO ED AGLI AGENTI ATMOSFERICI.
 IMPIEGO : PER IL PASSAGGIO D'ACQUA CALDA E LIQUIDI ANTIGELO NEI MOTORI, SETTORE AUTO E INDUSTRIA.



TUBE : CAOUTCHOUC EPDM RESISTANT A LA CHALEUR ET ANTIGEL.
 RENFORCEMENT : INSERTION TEXTILE HAUTE TENACITE.
 REVETEMENT : CAOUTCHOUC EPDM, RESISTANT A LA CHALEUR, AU VIELLISSEMENT ET AUX AGENTS ATMOSPHERIQUES.
 APPLICATION : POUR PASSAGE D'EAU CHAUDE ET ANTIGEL DANS LES SYSTEMES DE REFROIDISSEMENT DES MOTEURS THERMIQUES SECTEUR AUTOMOBILE ET INDUSTRIE.

ID		OD	WP		BP		W	L
inch	mm	mm	bar	psi	bar	psi	g/m	m
1/2"	12.7	19	4	58	12	174	215	1-40-46-61
5/8"	16	22	4	58	12	174	260	1-40-46-61
-	18	24	4	58	12	174	288	1-40-46-61
3/4"	19	25	4	58	12	174	302	1-40-46-61
-	20	26	4	58	12	174	315	1-40-46-61
7/8"	22	28	4	58	12	174	343	1-40-46-61
1"	25.4	32	4	58	12	174	432	1-40-46-61
1 1/8"	28	34.5	4	58	12	174	472	1-40-46-61
1 3/16"	30	38	4	58	12	174	600	1-40-46-61
1 1/4"	32	40	4	58	12	174	636	1-40-46-61
1 3/8"	35	43	4	58	12	174	690	1-40-46-61
1 1/2"	38	47	4	58	12	174	845	1-40-46-61
1 9/16"	40	49	4	58	12	174	886	1-40-46-61
1 5/8"	42	51	4	58	12	174	926	1-40-46-61
1 3/4"	44.5	54	4	58	12	174	1050	1-40-46-61
1 7/8"	48	57.5	4	58	12	174	1122	1-40-46-61
2"	50.8	60	4	58	12	174	1182	1-40-46-61
2 3/16"	55	65	4	58	12	174	1360	1-40-46-61
2 3/8"	60	70	4	58	12	174	1470	1-40-46-61
2 1/2"	63.5	73.5	4	58	12	174	1490	1-40-46-61
2 3/4"	70	80	4	58	12	174	1630	1-40-46-61
3"	76.2	86	4	58	12	174	1765	1-40-46-61
3 1/8"	80	90	4	58	12	174	1845	1-40-46-61
3 1/2"	90	100	4	58	12	174	2065	1-40-46-61
4"	101.6	111.5	4	58	12	174	2300	1-40-46-61

OPTIONS / OPTIONEN / OPZIONI / OPTIONS

Upon Request : DIN 73411 Type A/B - TS 548 Type 1/Type 2
 Auf Anfrage : DIN 73411 Type A/B - TS 548 Type 1/Type 2
 Su Richiesta : DIN 73411 Type A/B - TS 548 Type 1/Type 2
 Sur Demande : DIN 73411 Type A/B - TS 548 Type 1/Type 2



-40°C / +120°C
 -40°F / +248°F

MARKING / BESCHRIFTUNG / MARCATURA / MARQUAGE: **TRANSFER TAPE OR EMBOSSED**



NORMS NORMEN NORME NORMES	ISO 1307	COLOUR FARBEN COLORI COULEUR	
------------------------------------	----------	---------------------------------------	--

Hot Water



TUBE : EPDM RUBBER.
 REINFORCEMENT : HIGH TENSILE SYNTHETIC TEXTILE.
 COVER : ABRASION, HEAT, OZONE AND WEATHER RESISTANT, EPDM RUBBER.
 APPLICATION : FOR DELIVERY OF HOT WATER WITH VERY LIGHT CHEMICAL CONTENT IN INDUSTRIAL APPLICATIONS.



SEELE : EPDM-GUMMI.
 EINLAGE : HOCHZUGFESTE SYNTHETISCHE TEXTILEINLAGE.
 DECKE : EPDM, ABRIEBFEST, HITZE-, OZON- UND WITTERUNGSBESTÄNDIG, GLATT.
 ANWENDUNG : GEEIGNET ALS DRUCKSCHLAUCH IM INDUSTRIE- UND AUTOMOBILBEREICH FÜR FLÜSSIGE MEDIEN MIT ANTEILEN VON LEICHTEN CHEMIKALIEN.



SOTTOSTRATO : GOMMA IN EPDM.
 RINFORZO : INSERZIONI TESSILI AD ALTA TENACITÀ.
 COPERTURA : GOMMA IN EPDM, RESISTENTE ALL'ABRASIONE, AL CALORE, ALL'OZONO ED AGLI AGENTI ATMOSFERICI.
 IMPIEGO : PER MANDATA D'ACQUA CALDA ANCHE CON CONTENUTI CHIMICI MOLTO LEGGERI NELL'INDUSTRIA.



TUBE : CAOUTCHOUC EPDM.
 REINFORCEMENT : INSERTION TEXTILE HAUTE TENACITE.
 REVETEMENT : CAOUTCHOUC EPDM, RESISTANT A L'ABRASION, A LA CHALEUR, A L'OZONE ET AUX AGENTS ATMOSPHERIQUES.
 APPLICATION : POUR REFOULEMENT D'EAU CHAUDE MEME AVEC UN ADDITIF CHIMIQUE A FAIBLE CONCENTRATION, DANS L'INDUSTRIE.

ID		OD	WP		BP		W	L
inch	mm	mm	bar	psi	bar	psi	g/m	m
1/2"	12.7	20	10	145	30	435	280	40-46-61
5/8"	16	23	10	145	30	435	320	40-46-61
3/4"	19	27	10	145	30	435	423	40-46-61
1"	25.4	33	10	145	30	435	476	40-46-61
1 1/4"	32	41	10	145	30	435	715	40-46-61
1 1/2"	38	47	10	145	30	435	855	40-46-61
1 3/4"	44.5	54	10	145	30	435	1050	40-46-61
2"	50.8	60	10	145	30	435	1125	40-46-61
2 1/2"	63.5	74	10	145	30	435	1590	40-46-61
2 3/4"	70	82	10	145	30	435	2118	40-46-61
3"	76.2	88	10	145	30	435	2120	40-46-61
4"	101.6	115	10	145	30	435	3135	40-46-61
5"	127	140	10	145	30	435	3680	40-46-61
6"	152.4	165	10	145	30	435	4345	40-46-61
8"	203.2	222	10	145	30	435	8805	20



-40°C / +125°C
 -40°F / +257°F

MARKING / BESCHRIFTUNG / MARCATURA / MARQUAGE: **TRANSFER TAPE OR EMBOSSED**

SEL ISI-10 HOT WATER DELIVERY HOSE W.P. 10 Bar (145 PSI)

NORMS NORMEN NORME NORMES	ISO 1307	COLOUR FARBEN COLORI COULEUR	
------------------------------------	----------	---------------------------------------	--

Hot Water S&D



TUBE : EPDM RUBBER.
 REINFORCEMENT : HIGH TENSILE SYNTHETIC TEXTILE AND STEEL WIRE HELIX.
 COVER : ABRASION, HEAT, OZONE AND WEATHER RESISTANT, EPDM RUBBER.
 APPLICATION : FOR SUCTION AND DELIVERY OF HOT WATER WITH VERY LIGHT CHEMICAL CONTENT IN INDUSTRIAL APPLICATIONS.



SEELE : EPDM-GUMMI.
 EINLAGE : HOCHZUGFESTE TEXTILEINLAGE UND STAHLDRAHTSPIRALE.
 DECKE : ABRIEBFEST, WÄRME-, OZON- UND WITTERUNGSBESTÄNDIG, EPDM-GUMMI.
 ANWENDUNG : GEEIGNET ALS SAUG-DRUCKSCHLAUCH IM INDUSTRIEBEREICH FÜR HEISSE FLÜSSIGE MEDIEN MIT ANTEILEN VON LEICHTEN CHEMIKALIEN.



SOTTOSTRATO : GOMMA IN EPDM.
 RINFORZO : INSERZIONI TESSILI AD ALTA TENACITÀ CON SPIRALE D'ACCIAIO INCORPORATA.
 COPERTURA : GOMMA IN EPDM RESISTENTE AL CALORE, ALL'ABRASIONE, ALL'OZONO ED AGLI AGENTI ATMOSFERICI.
 IMPIEGO : PER ASPIRAZIONE E MANDATA D'ACQUA CALDA ANCHE CON CONTENUTI CHIMICI MOLTO LEGGERI NELL'INDUSTRIA.



TUBE : CAOUTCHOUC EPDM.
 RENFORCEMENT : INSERTION TEXTILE HAUTE TENACITE ET SPIRALE EN ACIER NOYEE.
 REVETEMENT : CAOUTCHOUC EPDM, RESISTANT A L'ABRASION, A LA CHALEUR, A L'OZONE ET AUX AGENTS ATMOSPHERIQUES.
 APPLICATION : POUR ASPIRATION ET REFOULEMENT D'EAU CHAUDE MEME AVEC UN ADDITIF CHIMIQUE A FAIBLE CONCENTRATION, DANS L'INDUSTRIE.

ID		OD		WP		BP		VACUUM	BR/r	W	L
inch	mm	mm	mm	bar	psi	bar	psi	bar	mm	g/m	m
3/4"	19	28	10	145	30	435	-0.92	70	510	40-46-61	
1"	25.4	34	10	145	30	435	-0.92	95	610	40-46-61	
1 1/4"	32	42	10	145	30	435	-0.92	125	960	40-46-61	
1 1/2"	38	48	10	145	30	435	-0.92	150	1130	40-46-61	
2"	50.8	62	10	145	30	435	-0.92	215	1685	40-46-61	
2 1/2"	63.5	75	10	145	30	435	-0.92	280	2066	40-46-61	
3"	76.2	89	10	145	30	435	-0.92	350	2815	40-46-61	
4"	101.6	115	10	145	30	435	-0.92	490	3797	40-46-61	



-40°C / +125°C
 -40°F / +257°F

MARKING / BESCHRIFTUNG / MARCATURA / MARQUAGE: **TRANSFER TAPE OR EMBOSSED**



NORMS NORMEN NORME NORMES	ISO 1307	COLOUR FARBEN COLORI COULEUR	
------------------------------------	----------	---------------------------------------	--



Hot Water S&D

CORRUGATED



TUBE : EPDM RUBBER.
 REINFORCEMENT : HIGH TENSILE SYNTHETIC TEXTILE AND STEEL WIRE HELIX.
 COVER : ABRASION, HEAT, OZONE AND WEATHER RESISTANT, CORRUGATED EPDM RUBBER.
 APPLICATION : FOR SUCTION AND DELIVERY OF HOT WATER WITH VERY LIGHT CHEMICAL CONTENT IN INDUSTRIAL APPLICATIONS.



SEELE : EPDM-GUMMI.
 EINLAGE : HOCHZUGFESTE TEXTILEINLAGE UND STAHLDRAHTSPIRALE.
 DECKE : ABRIEBFEST, WÄRME-, OZON- UND WITTERUNGSBESTÄNDIG, EPDM-GUMMI, GEWELLT.
 ANWENDUNG : GEEIGNET ALS SAUG-DRUCKSCHLAUCH IM INDUSTRIEBEREICH FÜR HEISSE FLÜSSIGE MEDIEN MIT ANTEILEN VON LEICHTEN CHEMIKALIEN.



SOTTOSTRATO : GOMMA IN EPDM.
 RINFORZO : INSERZIONI TESSILI AD ALTA TENACITÀ CON SPIRALE D'ACCIAIO INCORPORATA.
 COPERTURA : GOMMA IN EPDM ONDULATA RESISTENTE AL CALORE, ALL'ABRASIONE, ALL'OZONO ED AGLI AGENTI ATMOSFERICI.
 IMPIEGO : PER ASPIRAZIONE E MANDATA D'ACQUA CALDA ANCHE CON CONTENUTI CHIMICI MOLTO LEGGERI NELL'INDUSTRIA.



TUBE : CAOUTCHOUC EPDM.
 REINFORCEMENT : INSERTION TEXTILE HAUTE TENACITE ET SPIRALE EN ACIER NOYEE.
 REVETEMENT : CAOUTCHOUC EPDM ONDULE, RESISTANT A L'ABRASION, A LA CHALEUR, A L'OZONE ET AUX AGENTS ATMOSPHERIQUES.
 APPLICATION : POUR ASPIRATION ET REFOULEMENT D'EAU CHAUDE MEME AVEC UN ADDITIF CHIMIQUE A FAIBLE CONCENTRATION, DANS L'INDUSTRIE.

ID		OD		WP		BP		VACUUM	BR/r	W	L
inch	mm	mm	mm	bar	psi	bar	psi	bar	mm	g/m	m
1"	25.4	35	10	145	30	435	-0.92	85	690	40-46-61	
1 1/4"	32	42	10	145	30	435	-0.92	110	825	40-46-61	
1 1/2"	38	48	10	145	30	435	-0.92	125	960	40-46-61	
2"	50.8	63	10	145	30	435	-0.92	200	1560	40-46-61	
2 1/2"	63.5	74	10	145	30	435	-0.92	250	1927	40-46-61	
3"	76.2	90	10	145	30	435	-0.92	320	2785	40-46-61	
4"	101.6	117	10	145	30	435	-0.92	450	4085	40-46-61	



-40°C / +125°C
 -40°F / +257°F

MARKING / BESCHRIFTUNG / MARCATURA / MARQUAGE: **TRANSFER TAPE OR EMBOSSED**

SEL ISI SDC HOT WATER S/D HOSE W.P. 10 Bar (145 PSI)

NORMS NORMEN NORME NORMES	ISO 1307	COLOUR FARBEN COLORI COULEUR	
------------------------------------	----------	---------------------------------------	--

Hot Water S&D

FLAT CORRUGATED



TUBE : EPDM RUBBER.
 REINFORCEMENT : HIGH TENSILE SYNTHETIC TEXTILE AND STEEL WIRE HELIX.
 COVER : ABRASION, HEAT, OZONE AND WEATHER RESISTANT, FLAT CORRUGATED EPDM RUBBER.
 APPLICATION : FOR SUCTION AND DELIVERY OF HOT WATER WITH VERY LIGHT CHEMICAL CONTENT IN INDUSTRIAL APPLICATIONS.



SEELE : EPDM-GUMMI.
 EINLAGE : HOCHZUGFESTE TEXTILEINLAGE UND STAHLDRAHTSPIRALE.
 DECKE : ABRIEBFEST, WÄRME-, OZON- UND WITTERUNGSBESTÄNDIG, EPDM-GUMMI, GEWELLT.
 ANWENDUNG : GEEIGNET ALS SAUG-DRUCKSCHLAUCH IM INDUSTRIEBEREICH FÜR HEISSE FLÜSSIGE MEDIEN MIT ANTEILEN VON LEICHTEN CHEMIKALIEN.



SOTTOSTRATO : GOMMA IN EPDM.
 RINFORZO : INSERZIONI TESSILI AD ALTA TENACITÀ CON SPIRALE D'ACCIAIO INCORPORATA.
 COPERTURA : GOMMA IN EPDM ONDULATA PIATTA RESISTENTE AL CALORE, ALL'ABRASIONE, ALL'OZONO ED AGLI AGENTI ATMOSFERICI.
 IMPIEGO : PER ASPIRAZIONE E MANDATA D'ACQUA CALDA ANCHE CON CONTENUTI CHIMICI MOLTO LEGGERI NELL'INDUSTRIA.



TUBE : CAOUTCHOUC EPDM.
 RENFORCEMENT : INSERTION TEXTILE HAUTE TENACITE ET SPIRALE EN ACIER NOYEE.
 REVETEMENT : CAOUTCHOUC EPDM ONDULE PLAT, RESISTANT A L'ABRASION, A LA CHALEUR, A L'OZONE ET AUX AGENTS ATMOSPHERIQUES.
 APPLICATION : POUR ASPIRATION ET REFOULEMENT D'EAU CHAUDE MEME AVEC UN ADDITIF CHIMIQUE A FAIBLE CONCENTRATION, DANS L'INDUSTRIE.

ID		OD		WP		BP		VACUUM	BR/r	W	L
inch	mm	mm	mm	bar	psi	bar	psi	bar	mm	g/m	m
3/4"	19	27		10	145	30	435	-0.92	50	435	40-46-61
1"	25.4	34		10	145	30	435	-0.92	65	595	40-46-61
1 1/4"	32	41		10	145	30	435	-0.92	80	815	40-46-61
1 1/2"	38	47		10	145	30	435	-0.92	100	930	40-46-61
2"	50.8	61		10	145	30	435	-0.92	140	1450	40-46-61
2 1/2"	63.5	74		10	145	30	435	-0.92	175	1750	40-46-61
3"	76.2	88		10	145	30	435	-0.92	250	2310	40-46-61
4"	101.6	115		10	145	30	435	-0.92	350	3755	40-46-61
5"	127	143		10	145	30	435	-0.80	440	5710	40-46-61
6"	152.4	169		10	145	30	435	-0.80	600	7355	40-46-61



-40°C / +125°C
 -40°F / +257°F

MARKING / BESCHRIFTUNG / MARCATURA / MARQUAGE: **TRANSFER TAPE OR EMBOSSED**



NORMS NORMEN NORME NORMES	ISO 1307	COLOUR FARBEN COLORI COULEUR	
------------------------------------	----------	---------------------------------------	--



Hot Water S&D

CHANNELED



TUBE : EPDM RUBBER.
 REINFORCEMENT : HIGH TENSILE SYNTHETIC TEXTILE AND STEEL WIRE HELIX.
 COVER : ABRASION, HEAT, OZONE AND WEATHER RESISTANT, CHANNELED EPDM RUBBER.
 APPLICATION : FOR SUCTION AND DELIVERY OF HOT WATER WITH VERY LIGHT CHEMICAL CONTENT IN INDUSTRIAL APPLICATIONS.



SEELE : EPDM-GUMMI.
 EINLAGE : HOCHZUGFESTE TEXTILEINLAGE UND STAHLDRAHTSPIRALE.
 DECKE : ABRIEBFEST, WÄRME-, OZON- UND WITTERUNGSBESTÄNDIG, EPDM-GUMMI, KÖRDEL GERIPPT
 ANWENDUNG : GEEIGNET ALS SAUG-DRUCKSCHLAUCH IM INDUSTRIEBEREICH FÜR HEISSE FLÜSSIGE MEDIEN MIT ANTEILEN VON LEICHTEN CHEMIKALIEN.



SOTTOSTRATO : GOMMA IN EPDM.
 RINFORZO : INSERZIONI TESSILI AD ALTA TENACITÀ CON SPIRALE D'ACCIAIO INCORPORATA.
 COPERTURA : GOMMA IN EPDM GRECATA RESISTENTE AL CALORE, ALL'ABRASIONE, ALL'OZONO ED AGLI AGENTI ATMOSFERICI.
 IMPIEGO : PER ASPIRAZIONE E MANDATA D'ACQUA CALDA ANCHE CON CONTENUTI CHIMICI MOLTO LEGGERI NELL'INDUSTRIA.



TUBE : CAOUTCHOUC EPDM.
 REINFORCEMENT : INSERTION TEXTILE HAUTE TENACITE ET SPIRALE EN ACIER NOYEE.
 REVETEMENT : CAOUTCHOUC EPDM ASPECT CRENELLE, RESISTANT A L'ABRASION, A LA CHALEUR, A L'OZONE ET AUX AGENTS ATMOSPHERIQUES.
 APPLICATION : POUR ASPIRATION ET REFOULEMENT D'EAU CHAUDE MEME AVEC UN ADDITIF CHIMIQUE A FAIBLE CONCENTRATION, DANS L'INDUSTRIE.

ID		OD		WP		BP		VACUUM	BR/r	W	L
inch	mm	mm	mm	bar	psi	bar	psi	bar	mm	g/m	m
3/4"	19	29	10	145	30	435	-0.92	40	500	40-46-61	
7/8"	22	32	10	145	30	435	-0.92	45	570	40-46-61	
1"	25.4	35	10	145	30	435	-0.92	50	615	40-46-61	
1 1/8"	28	38	10	145	30	435	-0.92	55	735	40-46-61	
1 1/4"	32	42	10	145	30	435	-0.92	65	810	40-46-61	
1 1/2"	38	48	10	145	30	435	-0.92	85	1095	40-46-61	
2"	50.8	62	10	145	30	435	-0.92	120	1350	40-46-61	
2 1/2"	63.5	75	10	145	30	435	-0.92	160	1785	40-46-61	
3"	76.2	90	8	116	24	348	-0.92	190	2550	40-46-61	
4"	101.6	117	8	116	24	348	-0.92	280	3920	40-46-61	
5"	127	146	8	116	24	348	-0.80	350	6040	40-46-61	
6"	152.4	170	8	116	24	348	-0.80	550	6670	40-46-61	



-40°C / +125°C
 -40°F / +257°F

MARKING / BESCHRIFTUNG / MARCATURA / MARQUAGE: **TRANSFER TAPE OR EMBOSSED**



NORMS NORMEN NORME NORMES	ISO 1307	COLOUR FARBEN COLORI COULEUR	
------------------------------------	----------	---------------------------------------	--

Glass Fibre Cover Hot Water

Outside Temp. up to 600 °C



TUBE : EPDM RUBBER.
 REINFORCEMENT : HIGH TENSILE SYNTHETIC TEXTILE.
 COVER : HEAT (UP TO 600 °C) RESISTANT EPDM RUBBER AND GLASS FIBRE.
 APPLICATION : FOR DISCHARGE OF COOLING WATER IN VERY HIGH AMBIENT TEMPERATURE, IN STEEL MILLS, FOUNDRIES ETC.



SEELE : EPDM-GUMMI.
 EINLAGE : HOCHZUGFESTE TEXTILEINLAGE.
 DECKE : BIS ZU 600 °C HITZEBESTÄNDIGER EPDM-GUMMI MIT GLASFASERUMFLECHTUNG.
 ANWENDUNG : GEEIGNET ALS INDUSTRIESCHLAUCH IN GIEßEREIEN SOWIE STAHLWERKEN MIT HOHEN UMGEBUNGSTEMPERATUREN.



SOTTOSTRATO : GOMMA IN EPDM.
 RINFORZO : INSERZIONI TESSILI AD ALTA TENACITÀ.
 COPERTURA : GOMMA IN EPDM E FIBRA DI VETRO, RESISTENTE AL CALORE FINO A 600°C.
 IMPIEGO : PER MANDATA D'ACQUA DI RAFFREDDAMENTO NELLE CONDIZIONI AMBIENTALI A TEMPERATURA MOLTO ALTA, ACCIAIERIE, FONDERIE ETC.



TUBE : CAOUTCHOUC EPDM.
 RENFORCEMENT : INSERTION TEXTILE HAUTE TENACITE..
 REVETEMENT : CAOUTCHOUC EPDM ET FIBRE DE VERRE, RESISTANT A LA CHALEUR JUSQU'A 600 °C.
 APPLICATION : REFOULEMENT D'EAU DE REFROIDISSEMENT DANS LES MILIEUX OU LA TEMPERATURE EXTERIEURE EST TRES ELEVEE, COMME LES ACIERIES, FONDERIES ETC.

ID		OD	WP		BP		W	L
inch	mm	mm	bar	psi	bar	psi	g/m	m
3/8"	9.5	18	10	145	30	435	273	40-46-61
1/2"	12.7	21.5	10	145	30	435	354	40-46-61
5/8"	16	25	10	145	30	435	415	40-46-61
3/4"	19	28	10	145	30	435	482	40-46-61
1"	25.4	34	10	145	30	435	600	40-46-61
1 1/4"	32	42	10	145	30	435	817	40-46-61
1 3/8"	35	46	10	145	30	435	950	40-46-61
1 1/2"	38	50	10	145	30	435	1170	40-46-61
1 3/4"	44.5	57	10	145	30	435	1385	40-46-61
2"	50.8	63.5	10	145	30	435	1640	40-46-61
2 1/2"	63.5	76.5	10	145	30	435	2035	40-46-61
2 3/4"	70	83	10	145	30	435	2260	40-46-61
3"	76.2	90	10	145	30	435	2575	40-46-61
4"	101.6	116	10	145	30	435	3445	40-46-61
5"	127	142	10	145	30	435	4310	40-46-61
6"	152.4	167	10	145	30	435	5160	40-46-61
8"	203.2	221	10	145	30	435	8275	20
10"	254	274	10	145	30	435	11800	20



-40°C / +125°C
 -40°F / +257°F

NORMS
 NORMEN
 NORME
 NORMES

ISO 1307

COLOUR
 FARBEN
 COLORI
 COULEUR



Steam
Dampf
Vapore
Vapeur

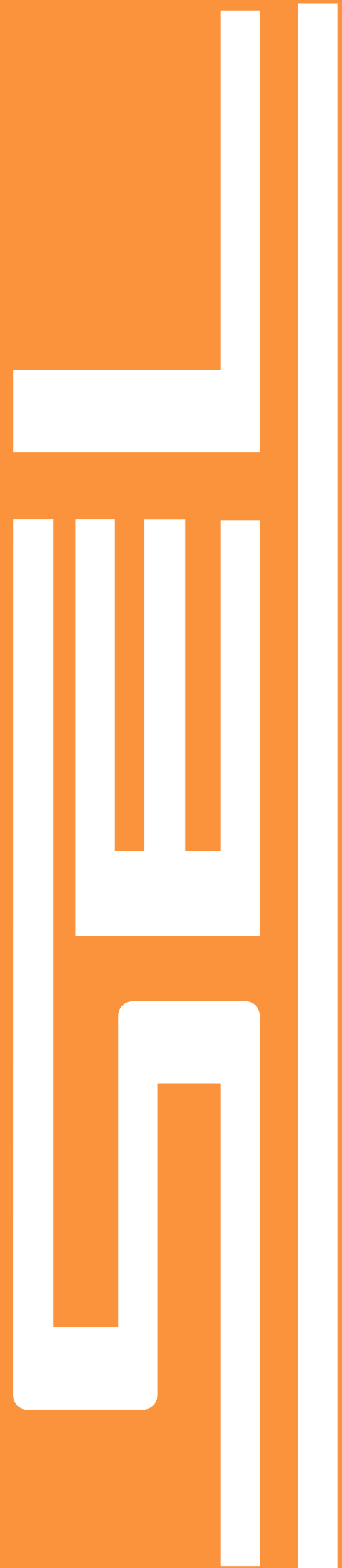
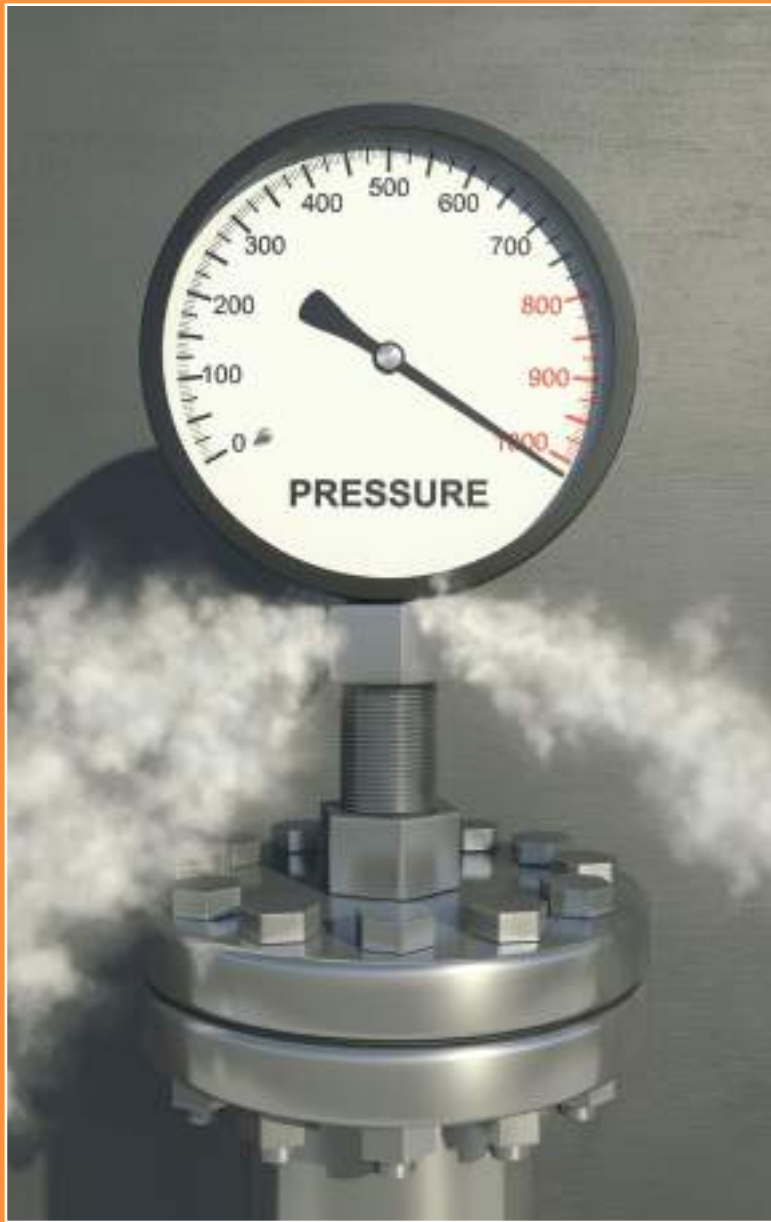

Textile Steam



TUBE : EPM RUBBER, RESISTANT TO SATURATED STEAM.
 REINFORCEMENT : HIGH TENSILE SYNTHETIC TEXTILE.
 COVER : ABRASION, HEAT, STEAM, OZONE AND WEATHER RESISTANT, PIN-PRICKED SPECIAL SYNTHETIC RUBBER.
 APPLICATION : FOR GENERAL SATURATED STEAM SERVICES AT A MAXIMUM WORKING PRESSURE OF 7 BARS (102 PSI).



SEELE : EPM GUMMI, SATTDAMPFBESTÄNDIG.
 EINLAGE : HOCHZUGFESTE SYNTHETISCHE TEXTILEINLAGE.
 DECKE : ABRIEBFEST, DAMPF-, OZON- UND WITTERUNGSBESTÄNDIG, SPEZIELL GEPRICKTER SYNTHETISCHER GUMMI.
 ANWENDUNG : FÜR ANWENDUNGEN MIT SATTDAMPF MIT EINEM MAXIMALEN BETRIEBSDRUCK VON 7 BAR (102 PSI).



SOTTOSTRATO : GOMMA EPM, RESISTENTE AL VAPORE SATURO.
 RINFORZO : INSERZIONI TESSILI AD ALTA TENACITÀ.
 COPERTURA : GOMMA SPECIALE SINTETICA MICRO-FORATA RESISTENTE AL CALORE, AL VAPORE, ALL'ABRASIONE, ALL'OZONO ED AGLI AGENTI ATMOSFERICI.
 IMPIEGO : PASSAGGIO DI VAPORE SATURO PER USO INDUSTRIALE GENERALE AD UNA PRESSIONE MASSIMA DI ESERCIZIO DI 7 BAR (102 PSI).



TUBE : CAOUTCHOUC EPM, RESISTANT A LA VAPEUR SATUREE..
 RENFORCEMENT : INSERTION TEXTILE HAUTE TENACITE.
 REVETEMENT : CAOUTCHOUC SYNTHETIQUE SPECIAL MICRO-PERFORE, RESISTANT A L'ABRASION, A LA CHALEUR, A LA VAPEUR, A L'OZONE ET AUX AGENTS ATMOSPHERIQUES.
 APPLICATION : POUR SERVICES GENERAUX DE VAPEUR SATUREE A UNE PRESSION MAXIMALE DE 7 BAR (102 PSI).

ID		OD		WP		BP		W	L
inch	mm	mm	bar	psi	bar	psi	g/m	m	
3/8"	9.5	20	7	102	70	1015	260	40-46-61	
1/2"	12.7	24	7	102	70	1015	322	40-46-61	
5/8"	16	28	7	102	70	1015	456	40-46-61	
3/4"	19	31	7	102	70	1015	525	40-46-61	
1"	25.4	37	7	102	70	1015	610	40-46-61	
1 1/4"	32	46	7	102	70	1015	942	40-46-61	
1 1/2"	38	53	7	102	70	1015	1166	40-46-61	
1 3/4"	44.5	60	7	102	70	1015	1400	40-46-61	
2"	50.8	67.5	7	102	70	1015	1747	40-46-61	
2 1/2"	63.5	81	7	102	70	1015	2229	40-46-61	
3"	76.2	98	7	102	70	1015	3312	40-46-61	
4"	101.6	124	7	102	70	1015	4443	40-46-61	



-40°C / +165°C
 -40°F / +329°F

MARKING / BESCHRIFTUNG / MARCATURA / MARQUAGE: **TRANSFER TAPE OR EMBOSSED**



NORMS NORMEN NORME NORMES	ISO 1307	COLOUR FARBEN COLORI COULEUR	
------------------------------------	----------	---------------------------------------	--



Textile Steam

ISO 6134-1A



TUBE : EPM RUBBER, RESISTANT TO SATURATED STEAM.
 REINFORCEMENT : HIGH TENSILE SYNTHETIC TEXTILE AND ANTISTATIC COPPER WIRE.
 COVER : ABRASION, HEAT, STEAM, OZONE AND WEATHER RESISTANT, PIN-PRICKED SPECIAL SYNTHETIC RUBBER.
 APPLICATION : FOR GENERAL SATURATED STEAM SERVICES AT A MAXIMUM WORKING PRESSURE OF 6 BARS (87 PSI).



SEELE : EPM GUMMI, SATTDAMPFBESTÄNDIG.
 EINLAGE : HOCHZUGFESTE SYNTHETISCHE TEXTILEINLAGE UND ANTISTATISCHER KUPFERDRAHT.
 DECKE : ABRIEBFEST, DAMPF-, OZON- UND WITTERUNGSBESTÄNDIG, SPEZIELL GEPRICKTER SYNTHETISCHER GUMMI.
 ANWENDUNG : FÜR ANWENDUNGEN MIT SATTDAMPF MIT EINEM MAXIMALEN BETRIEBSDRUCK VON 6 BAR (87 PSI).



SOTTOSTRATO : GOMMA IN EPM, RESISTENTE AL VAPORE SATURO.
 RINFORZO : INSERZIONI TESSILI AD ALTA TENACITÀ E FILO DI RAME ANTISTATICO.
 COPERTURA : GOMMA SPECIALE SINTETICA MICRO-FORATA RESISTENTE AL CALORE, AL VAPORE, ALL'ABRASIONE, ALL'OZONO ED AGLI AGENTI ATMOSFERICI.
 IMPIEGO : PASSAGGIO DI VAPORE SATURO PER USO INDUSTRIALE GENERALE AD UNA PRESSIONE MASSIMA DI ESERCIZIO DI 6 BAR (87 PSI).



TUBE : CAOUTCHOUC EPM, RESISTANT A LA VAPEUR SATUREE..
 RENFORCEMENT : INSERTION TEXTILE HAUTE TENACITE ET FIL DE MASSE ANTISTATIQUE.
 REVETEMENT : CAOUTCHOUC SYNTHETIQUE SPECIAL MICRO-PERFORE, RESISTANT A L'ABRASION, A LA CHALEUR, A LA VAPEUR, A L'OZONE ET AUX AGENTS ATMOSPHERIQUES.
 APPLICATION : POUR SERVICES GENERAUX DE VAPEUR SATUREE A UNE PRESSION MAXIMALE DE 6 BAR (87 PSI).

ID		OD		WP		BP		BR/r	W	L
inch	mm	mm	mm	bar	psi	bar	psi	mm	g/m	m
1/2"	12.7	25	25	6	87	60	870	130	390	46
5/8"	16	30	30	6	87	60	870	160	560	46
3/4"	19	33	33	6	87	60	870	190	630	46-61
1"	25.4	40	40	6	87	60	870	250	811	46-61
1 1/4"	32	48	48	6	87	60	870	320	1110	46-61
1 1/2"	38	54	54	6	87	60	870	380	1275	46-61
2"	50.8	69	69	6	87	60	870	500	1885	46-61
2 1/2"	63.5	81	81	6	87	60	870	630	2226	46-61
3"	76.2	94	94	6	87	60	870	750	2758	46-61
4"	101.6	122	122	6	87	60	870	1000	4020	46-61



-40°C / +165°C
 -40°F / +329°F



MARKING / BESCHRIFTUNG / MARCATURA / MARQUAGE: **TRANSFER TAPE OR EMBOSSED**

SEL BUHAR - 1A STEAM HOSE - TS EN ISO 6134 - 1A - W.P. 6 Bar (87 PSI) - 165 °C - M

NORMS NORMEN NORME NORMES	ISO 6134 TYPE1 CLASS A TS EN ISO 6134 TYPE 1 CLASS A ISO 1307	COLOUR FARBEN COLORI COULEUR	
------------------------------------	---	---------------------------------------	--

Textile Steam

ISO 6134-1B - Oil Resistant Cover



TUBE : EPM RUBBER, RESISTANT TO SATURATED STEAM.
 REINFORCEMENT : HIGH TENSILE SYNTHETIC TEXTILE AND ANTISTATIC COPPER WIRE.
 COVER : ABRASION, HEAT, STEAM, OIL, OZONE AND WEATHER RESISTANT, PIN-PRICKED SPECIAL SYNTHETIC RUBBER.
 APPLICATION : FOR GENERAL SATURATED STEAM SERVICES AT A MAXIMUM WORKING PRESSURE OF 6 BARS (87 PSI).



SEELE : EPM GUMMI, SATTDAMPFBESTÄNDIG.
 EINLAGE : HOCHZUGFESTE SYNTHETISCHE TEXTILEINLAGE UND ANTISTATISCHER KUPFERDRAHT.
 DECKE : ABRIEBFEST, DAMPF-, ÖL-, OZON- UND WITTERUNGSBESTÄNDIG, SPEZIELL GEPRICKTER SYNTHETISCHER GUMMI.
 ANWENDUNG : FÜR ANWENDUNGEN MIT SATTDAMPF MIT EINEM MAXIMALEN BETRIEBSDRUCK VON 6 BAR (87 PSI).



SOTTOSTRATO : GOMMA IN EPM, RESISTENTE AL VAPORE SATURO.
 RINFORZO : INSERZIONI TESSILI AD ALTA TENACITÀ E FILO DI RAME ANTISTATICO.
 COPERTURA : GOMMA SPECIALE SINTETICA MICRO-FORATA RESISTENTE AL CALORE, AL VAPORE, AGLI OLI, ALL'ABRASIONE, ALL'OZONO ED AGLI AGENTI ATMOSFERICI.
 IMPIEGO : PASSAGGIO DI VAPORE SATURO PER USO INDUSTRIALE GENERALE AD UNA PRESSIONE MASSIMA DI ESERCIZIO DI 6 BAR (87 PSI).



TUBE : CAOUTCHOUC EPM, RESISTANT A LA VAPEUR SATUREE.
 RENFORCEMENT : INSERTION TEXTILE HAUTE TENACITE ET FIL DE MASSE ANTISTATIQUE.
 REVETEMENT : CAOUTCHOUC SYNTHETIQUE SPECIAL MICRO-PERFORE, RESISTANT A L'ABRASION, A LA CHALEUR, A LA VAPEUR, AUX HUILES, A L'OZONE ET AUX AGENTS ATMOSPHERIQUES.
 APPLICATION : POUR SERVICES GENERAUX DE VAPEUR SATUREE A UNE PRESSION MAXIMALE DE 6 BAR (87 PSI).

ID		OD		WP		BP		BR/r	W	L
inch	mm	mm	mm	bar	psi	bar	psi	mm	g/m	m
1/2"	12.7	25	6	87	60	870	130	420	46	
5/8"	16	30	6	87	60	870	160	595	46	
3/4"	19	33	6	87	60	870	190	670	46-61	
1"	25.4	40	6	87	60	870	250	860	46-61	
1 1/4"	32	48	6	87	60	870	320	1180	46-61	
1 1/2"	38	54	6	87	60	870	380	1355	46-61	
2"	50.8	69	6	87	60	870	500	2000	46-61	
2 1/2"	63.5	81	6	87	60	870	630	2350	46-61	
3"	76.2	94	6	87	60	870	750	2875	46-61	
4"	101.6	122	6	87	60	870	1000	4170	46-61	



-40°C / +165°C
 -40°F / +329°F

MARKING / BESCHRIFTUNG / MARCATURA / MARQUAGE: **TRANSFER TAPE OR EMBOSSED**

SEL BUHAR - 1B STEAM HOSE - TS EN ISO 6134 - 1B - W.P. 6 Bar (87 PSI) - 165 °C - M

NORMS NORMEN NORME NORMES	ISO 6134 TYPE 1 CLASS B TS EN ISO 6134 TYPE 1 CLASS B ISO 1307	COLOUR FARBEN COLORI COULEUR	
------------------------------------	--	---------------------------------------	--



Steel Wire Reinforced Steam 200 °C



TUBE : EPM RUBBER. RESISTANT TO SATURATED STEAM.
 REINFORCEMENT : HIGH TENSILE STEEL WIRE CORDS.
 COVER : ABRASION. HEAT. STEAM. OIL. OZONE AND WEATHER RESISTANT. PIN-PRICKED SPECIAL SYNTHETIC RUBBER.
 APPLICATION : FOR SATURATED STEAM SERVICES AT A MAXIMUM WORKING PRESSURE OF 17 BARS (247 PSI) IN CHEMICAL PLANTS. STEEL MILLS. REFINERIES. SHIPYARDS AND ALL INDUSTRIES.



SEELE : EPM GUMMI. SATTDAMPFBESTÄNDIG.
 EINLAGE : HOCHZUGFESTE STAHLKORDEINLAGE.
 DECKE : ABRIEBFEST. HITZE-. DAMPF-. ÖL-. OZON- UND WITTERUNGSBESTÄNDIG. SPEZIELL GEPRICKTER SYNTHETISCHER GUMMI.
 ANWENDUNG : GEEIGNET FÜR ANWENDUNGEN MIT SATTDAMPF MIT MAX. 17 BAR (247 PSI) FÜR CHEMIEINDUSTRIE. STAHLWERKE. RAFFINERIEEN. WERFTEN UND ALLEN INDUSTRIEBEREICHEN.



SOTTOSTRATO : GOMMA EPM. RESISTENTE AL VAPORE SATURO.
 RINFORZO : CORDINE D'ACCIAIO AD ALTA TENACITÀ.
 COPERTURA : GOMMA SPECIALE SINTETICA MICRO-FORATA RESISTENTE AL CALORE. AL VAPORE. AGLI OLI. ALL'ABRASIONE. ALL'OZONO ED AGLI AGENTI ATMOSFERICI.
 IMPIEGO : VAPORE SATURO CON UNA PRESSIONE MASSIMA D'ESERCIZIO DI 17 BAR (247 PSI) USATO NEI CANTIERI NAVALI. NEGLI IMPIANTI CHIMICI. NELLE RAFFINERIE ETC.



TUBE : CAOUTCHOUC EPM. RESISTANT A LA VAPEUR SATUREE.
 RENFORCEMENT : NAPPES METALLIQUES HAUTE TENACITE.
 REVETEMENT : CAOUTCHOUC SYNTHETIQUE SPECIAL MICRO-PERFORE. RESISTANT A L'ABRASION. A LA CHALEUR. A LA VAPEUR. AUX HUILES. A L'OZONE ET AUX AGENTS ATMOSPHERIQUES.
 APPLICATION : POUR LA VAPEUR SATUREE AVEC UNE PRESSION MAXIMALE DE 17 BAR (247 PSI) DANS L'INDUSTRIE CHIMIQUE. LES ACIERIES. LES RAFFINERIES. LES CHANTIERS NAVALES ETC.

ID		OD		WP		BP		BR/r	W	L
inch	mm	mm	mm	bar	psi	bar	psi	mm	g/m	m
1/2"	12.7	24	24	17	247	170	2465	70	485	40-61
5/8"	16	27	27	17	247	170	2465	80	555	40-61
3/4"	19	32	32	17	247	170	2465	100	720	40-61
1"	25.4	38.5	38.5	17	247	170	2465	140	955	40-61
1 1/4"	32	46	46	17	247	170	2465	200	1265	40-61
1 1/2"	38	52	52	17	247	170	2465	250	1580	40-61
2"	50.8	67	67	17	247	170	2465	350	2365	40-61
2 1/2"	63.5	79.5	79.5	17	247	170	2465	450	2970	40-61
3"	76.2	93	93	17	247	170	2465	550	3880	40-61
4"	101.6	124	124	17	247	170	2465	750	6595	40-61

OPTIONS / OPTIONEN / OPZIONI / OPTIONS

Upon Request : Butyl tube
 Auf Anfrage : Butyl Seele
 Su Richiesta : Sottostrato in butile
 Sur Demande : Tube en butyle



-40°C / +203°C
 -40°F / +398°F

MARKING / BESCHRIFTUNG / MARCATURA / MARQUAGE: **TRANSFER TAPE OR EMBOSSED**



NORMS NORMEN NORME NORMES	EXCEED BS 5342 TYPE 2 CLASS A ISO 1307	COLOUR FARBEN COLORI COULEUR	
------------------------------------	--	---------------------------------------	--

Steel Wire Reinforced Steam 210 °C

ISO 6134-2A



TUBE : EPM RUBBER, RESISTANT TO SATURATED STEAM.
 REINFORCEMENT : HIGH TENSILE STEEL WIRE CORDS.
 COVER : ABRASION, HEAT, STEAM, OZONE AND WEATHER RESISTANT, PIN-PRICKED SPECIAL SYNTHETIC RUBBER.
 APPLICATION : FOR SATURATED STEAM SERVICES AT A MAXIMUM WORKING PRESSURE OF 18 BARS (261 PSI) IN CHEMICAL PLANTS, STEEL MILLS, REFINERIES, SHIPYARDS AND ALL INDUSTRIES.



SEELE : EPM GUMMI, SATTDAMPFBESTÄNDIG.
 EINLAGE : HOCHZUGFESTE STAHLKORDEINLAGE.
 DECKE : ABRIEBFEST, HITZE-, DAMPF-, OZON- UND WITTERUNGSBESTÄNDIG, SPEZIELL GEPRICKTER SYNTHETISCHER GUMMI.
 ANWENDUNG : GEEIGNET FÜR ANWENDUNGEN MIT SATTDAMPF MIT MAX. 18 BAR (261 PSI) FÜR CHEMIEINDUSTRIE, STAHLWERKE, RAFFINERIEN, WERFTEN UND ALLEN INDUSTRIEBEREICHEN.



SOTTOSTRATO : GOMMA EPM, RESISTENTE AL VAPORE SATURO.
 RINFORZO : CORDINE D'ACCIAIO AD ALTA TENACITÀ.
 COPERTURA : GOMMA SPECIALE SINTETICA MICRO-FORATA RESISTENTE AL CALORE, AL VAPORE, ALL'ABRASIONE, ALL'OZONO ED AGLI AGENTI ATMOSFERICI.
 IMPIEGO : VAPORE SATURO CON UNA PRESSIONE MASSIMA D'ESERCIZIO DI 18 BAR (261 PSI) USATO NEI CANTIERI NAVALI, NEGLI IMPIANTI CHIMICI, NELLE RAFFINERIE ETC.



TUBE : CAOUTCHOUC EPM, RESISTANT A LA VAPEUR SATUREE.
 RENFORCEMENT : NAPPES METALLIQUES HAUTE TENACITE.
 REVETEMENT : CAOUTCHOUC SYNTHETIQUE SPECIAL MICRO-PERFORE, RESISTANT A L'ABRASION, A LA CHALEUR, A LA VAPEUR, A L'OZONE ET AUX AGENTS ATMOSPHERIQUES.
 APPLICATION : POUR LA VAPEUR SATUREE AVEC UNE PRESSION MAXIMALE DE 18 BAR (261 PSI) DANS L'INDUSTRIE CHIMIQUE, LES ACIERIES, LES RAFFINERIES, LES CHANTIERS NAVALS ETC.

ID		OD	WP		BP		BR/r	W	L
inch	mm	mm	bar	psi	bar	psi	mm	g/m	m
1/2"	12.7	25	18	261	180	2610	130	530	40-61
5/8"	16	30	18	261	180	2610	160	750	40-61
3/4"	19	33	18	261	180	2610	190	780	40-61
1"	25.4	40	18	261	180	2610	250	1025	40-61
1 1/4"	32	48	18	261	180	2610	320	1410	40-61
1 1/2"	38	54	18	261	180	2610	380	1775	40-61
2"	50.8	69	18	261	180	2610	500	2580	40-61
2 1/2"	63.5	81	18	261	180	2610	630	3160	40-61
3"	76.2	94	18	261	180	2610	750	4015	40-61
4"	101.6	122	18	261	180	2610	1000	6215	40-61



-40 °C / +210 °C INTERMITTENT TO 232 °C
 -40 °F / +410 °F INTERMITTENT TO 450 °F

MARKING / BESCHRIFTUNG / MARCATURA / MARQUAGE: **TRANSFER TAPE OR EMBOSSED**

SEL GEYSER - 2A STEAM HOSE - TS EN ISO 6134 - 2A - W.P. 18 Bar (261 PSI) - 210 °C - M

NORMS NORMEN NORME NORMES	TS EN ISO 6134 TYPE 2- CLASS A ISO 1307	COLOUR FARBEN COLORI COULEUR	
------------------------------------	--	---------------------------------------	--



Steel Wire Reinforced Steam 210 °C

OIL RESISTANT COVER-ISO 6134-2B



TUBE : EPM RUBBER, RESISTANT TO SATURATED STEAM.
 REINFORCEMENT : HIGH TENSILE STEEL WIRE CORDS.
 COVER : ABRASION, HEAT, STEAM, OIL, OZONE AND WEATHER RESISTANT, PIN-PRICKED SPECIAL SYNTHETIC RUBBER.
 APPLICATION : FOR SATURATED STEAM SERVICES AT A MAXIMUM WORKING PRESSURE OF 18 BARS (261 PSI) IN CHEMICAL PLANTS, STEEL MILLS, REFINERIES, SHIPYARDS AND ALL INDUSTRIES.



SEELE : EPM GUMMI, SATTDAMPFBESTÄNDIG.
 EINLAGE : HOCHZUGFESTE STAHLKORDEINLAGE.
 DECKE : ABRIEBFEST, HITZE-, DAMPF-, ÖL-, OZON- UND WITTERUNGSBESTÄNDIG, SPEZIELL GEPRICKTER SYNTHETISCHER GUMMI.
 ANWENDUNG : GEEIGNET FÜR ANWENDUNGEN MIT SATTDAMPF MIT MAX. 18 BAR (261 PSI) FÜR CHEMIEINDUSTRIE, STAHLWERKE, RAFFINERIEEN, WERFTEN UND ALLEN INDUSTRIEBEREICHEN.



SOTTOSTRATO : GOMMA EPM, RESISTENTE AL VAPORE SATURO.
 RINFORZO : CORDINE D'ACCIAIO AD ALTA TENACITÀ.
 COPERTURA : GOMMA SPECIALE SINTETICA MICRO-FORATA RESISTENTE AL CALORE, AL VAPORE, AGLI OLI, ALL'ABRASIONE, ALL'OZONO ED AGLI AGENTI ATMOSFERICI.
 IMPIEGO : VAPORE SATURO CON UNA PRESSIONE MASSIMA D'ESERCIZIO DI 18 BAR (261 PSI) USATO NEI CANTIERI NAVALI, NEGLI IMPIANTI CHIMICI, NELLE RAFFINERIE ETC.



TUBE : CAOUTCHOUC EPM, RESISTANT A LA VAPEUR SATURÉE.
 RENFORCEMENT : NAPPES METALLIQUES HAUTE TENACITÉ.
 REVETEMENT : CAOUTCHOUC SYNTHETIQUE SPECIAL MICRO-PERFORE, RESISTANT A L'ABRASION, A LA CHALEUR, A LA VAPEUR, AUX HUILES, A L'OZONE ET AUX AGENTS ATMOSPHERIQUES.
 APPLICATION : POUR LA VAPEUR SATURÉE AVEC UNE PRESSION MAXIMALE DE 18 BAR (261 PSI) DANS L'INDUSTRIE CHIMIQUE, LES ACIERIES, LES RAFFINERIES, LES CHANTIERS NAVALS ETC.

ID		OD	WP		BP		BR/r	W	L
inch	mm	mm	bar	psi	bar	psi	mm	g/m	m
1/2"	12.7	25	18	261	180	2610	130	560	40-61
5/8"	16	30	18	261	180	2610	160	780	40-61
3/4"	19	33	18	261	180	2610	190	815	40-61
1"	25.4	40	18	261	180	2610	250	1070	40-61
1 1/4"	32	48	18	261	180	2610	320	1490	40-61
1 1/2"	38	54	18	261	180	2610	380	1865	40-61
2"	50.8	69	18	261	180	2610	500	2695	40-61
2 1/2"	63.5	81	18	261	180	2610	630	3205	40-61
3"	76.2	94	18	261	180	2610	750	4175	40-61
4"	101.6	122	18	261	180	2610	1000	6425	40-61



-40 °C / +210 °C INTERMITTENT TO 232 °C
 -40 °F / +410 °F INTERMITTENT TO 450 °F



MARKING / BESCHRIFTUNG / MARCATURA / MARQUAGE: **TRANSFER TAPE OR EMBOSSED**

SEL GEYSER - 2B STEAM HOSE - TS EN ISO 6134 - 2B - W.P. 18 Bar (261 PSI) - 210 °C - M

NORMS NORMEN NORME NORMES	TS EN ISO 6134 TYPE 2- CLASS B ISO 1307	COLOUR FARBEN COLORI COULEUR	
------------------------------------	--	---------------------------------------	--

Dairy Steam-Wash



TUBE : WHITE OIL AND STEAM RESISTANT, ODOUR FREE SPECIAL SYNTHETIC RUBBER.
 REINFORCEMENT : HIGH TENSILE SYNTHETIC TEXTILE.
 COVER : OIL, HEAT, ABRASION, OZONE AND WEATHER RESISTANT, SPECIAL SYNTHETIC RUBBER.
 APPLICATION : FOR CLEANING IN FOOD PROCESSING PLANTS (DAIRIES, ABATTOIRS ETC.) WITH HOT WATER AND STEAM.



SEELE : ÖL- UND DAMPF BESTÄNDIG, SPEZIELLER SYNTHETISCHER GUMMI, WEISS.
 EINLAGE : HOCHZUGFESTE SYNTHETISCHE TEXTILENLAGE.
 DECKE : ABRIEFEST, ÖL-, HITZE-, OZON- UND WITTERUNGSBESTÄNDIGER, SPEZIELLER SYNTHETISCHER GUMMI.
 ANWENDUNG : FÜR REINIGUNGSARBEITEN IN DER NAHRUNGSMITTELINDUSTRIE (MOLKEREIEN - SCHLACHTHÖFE) MIT HEISSWASSER UND SATTDAMPF.



SOTTOSTRATO : GOMMA SPECIALE SINTETICA BIANCA, ANTI ODORE, RESISTENTE AGLI OLI ED AL VAPORE.
 RINFORZO : INSERZIONI TESSILI AD ALTA TENACITÀ.
 COPERTURA : GOMMA SPECIALE SINTETICA, RESISTENTE AGLI OLI, AL CALORE, ALL'ABRASIONE, ALL'OZONO ED AGLI AGENTI ATMOSFERICI.
 IMPIEGO : PER LAVAGGIO CON ACQUA CALDA E VAPORE NELL'INDUSTRIA ALIMENTARE, NEI MACELLI ETC.



TUBE : CAOUTCHOUC SYNTHETIQUE SPECIAL BLANC, ANTI ODEUR RESISTANT A LA VAPEUR ET AUX HUILES.
 RENFORCEMENT : INSERTION TEXTILE HAUTE TENACITE.
 REVETEMENT : CAOUTCHOUC SYNTHETIQUE SPECIAL, RESISTANT A L'ABRASION, A LA CHALEUR, AUX HUILES, A L'OZONE ET AUX AGENTS ATMOSPERIQUES.
 APPLICATION : POUR LE NETTOYAGE A L'EAU ET A LA VAPEUR DANS L'INDUSTRIE ALIMENTAIRE, LES ABATTOIRS, LES FROMAGERIES ETC.

ID		OD		WP		BP		W	L
inch	mm	mm	bar	psi	bar	psi	g/m	m	
3/8"	9.5	20	7	102	70	1015	295	40-46-61	
1/2"	12.7	24	7	102	70	1015	408	40-46-61	
5/8"	16	28	7	102	70	1015	508	40-46-61	
3/4"	19	31	7	102	70	1015	595	40-46-61	
1"	25.4	37	7	102	70	1015	684	40-46-61	
1 1/4"	32	46	7	102	70	1015	1070	40-46-61	
1 1/2"	38	53	7	102	70	1015	1343	40-46-61	
1 3/4"	44.5	60	7	102	70	1015	1567	40-46-61	
2"	50.8	67.5	7	102	70	1015	1968	40-46-61	
2 1/2"	63.5	81	7	102	70	1015	2504	40-46-61	
3"	76.2	98	7	102	70	1015	3660	40-46-61	
4"	101.6	124	7	102	70	1015	4825	40-46-61	



-40°C / +125°C STEAM UP TO 165 °C
 -40°F / +257°F STEAM UP TO 329 °F

MARKING / BESCHRIFTUNG / MARCATURA / MARQUAGE: **TRANSFER TAPE OR EMBOSSED**



NORMS NORMEN NORME NORMES	ISO 1307 MEETS FDA AND EUROPEAN REQUIREMENTS	COLOUR FARBEN COLORI COULEUR	
------------------------------------	---	---------------------------------------	--



Security Instructions For Steam Hoses

Selection of Steam Hose

- Make sure that the selected hose satisfies steam hose construction requirements.
- The permanent branding on the hose outer cover must give hose identification information.
- You must identify the type of service the steam hose is being asked to accomplish.
 - a) Is the hose manually handled?
 - b) What is the anticipated frequency of use?
 - c) What is the pressure of the steam service?
 - d) Is it subject to peak pressures?
 - e) What is the temperature of the steam?
 - f) Saturated or superheated steam?
 - g) Specify the external conditions in the area where the hose will be serviced.
- You should know that accumulation of corrosive petroleum or chemical based materials externally can have a deteriorating effect on hose cover.

Installation of Steam Hose

- It is necessary to avoid the alternative use of the hose as water and steam which causes a phenomenon of 'popcorn'.
- You must ensure that the hose couplings are designed for steam hose service. Steam hose couplings use a bolt-on outside clamp which can be retightened as necessary over the service life of the hose. Follow the coupling manufacturer's instructions for coupling attachment. Check tightness with each use.
- Avoid extreme bending of the hose near the coupling.
- Provide a suitable means of storing the hose when not in use. A permanent tray will minimize the damage to the hose in storage. Do not hang the hose on a hook, nail or other device which could damage the hose.

Safety

- The operators must use gloves, rubber boots, full length protective clothing and eye protection. The objective is to provide protection from scalding burns resulting from splash-back of steam.
- The working area must be free of hazards and other clutter.
- Check tightness of coupling bolts with each use.
- Turning off the pressure, when the hose is not in service, can provide dramatic increases in steam hose service life.

Periodic Maintenance and Control of Steam Hose

All steam hoses are expected to wear out in a time period. It's important to continually check the hose for deterioration to the point where it can no longer provide safe service. The operator should be aware of the following signs of trouble:

- Cover blister or lumps.
- Cuts in the outside of the hose which expose the reinforcement.
- Steam leakages at the coupling ends or anywhere along the length of the hose.
- Flattened or kinked areas which have damaged the hose.
- Steam flow reduction indicates that the tube is swelling.
- When any of the above abnormalities appear it is good safety practice to immediately remove the hose from service. Once removed, the hose can be carefully inspected before further use. Steam hose failures frequently occur near the ends due to flexing and strain at the couplings. In these cases the hose can usually be cut back and recoupled, providing additional service life. When the hose is subject to continuous high pressure/temperature service should be inspected periodically for signs of tube hardening. In most cases it is necessary to remove a coupling for tube inspection.

Safety Warning

Contact with steam is dangerous and if not properly handled, steam can cause damage to property, serious injuries and even death. In order to avoid damage to property, serious injury or death you must select the proper steam hose for the given application. Appropriate installation, usage and maintenance of the steam hose you select will contribute to increasing operator safety. The following information is offered to assist you in each area.

Properties of Saturated Steam			
Working Pressure		Temperature of Saturated Steam	
kg/cm ²	psi	°C	°F
1	14	99	210
2	28	120	248
3	43	133	272
4	57	143	290
5	71	151	304
6	85	158	316
7	99	164	328
8	114	170	338
9	128	175	348
10	142	179	354
11	156	183	362
12	170	187	368
13	185	191	376
14	199	194	382
15	213	197	386
16	227	200	392
17	241	203	398
18	256	206	403
19	270	209	408
20	284	211	412
22	312	216	421
24	341	221	430
26	369	225	438

Cleaning

It can be washed and sterilised with usual detergents or steam cleaned to a temperature of +120°C (+248°F) for short periods.

Recommendations

The hose must be left empty after use.

Sicherheitshinweise für Dampfschläuche

- Verwenden Sie ausschliesslich Schläuche welche deutlich als Dampfschlauch markiert sind
- Dampfschläuche müssen zweckentsprechend auf dem Schlauch selbst dauerhaft gekennzeichnet sein
- Die Einsatzbedingungen für Dampfschläuche müssen entsprechend folgendem Schema kontrolliert werden:
 - a) Werden die Schläuche von Hand bewegt
 - b) In welchen Zeitabständen soll der Schlauch eingesetzt werden
 - c) Wie hoch ist der Systemdruck
 - d) Treten Druckspitzen auf
 - e) Temperatur des Dampfes
 - f) Handelt es sich um Sattdampf oder überhitzten Dampf
 - g) Welche Umwelteinflüsse wirken auf den Schlauch ein
- Vermeiden Sie Kontakt der Schlauchdecke mit Ölen oder Chemikalien, da dies die Lebensdauer des Schlauches stark beeinträchtigen kann.

Einbindung des Schlauches

- Der Schlauch darf nur für dampfarbeiten benutzt werden. Nach jedem gebrauch muss der schlauch vom kondensiertem wasser befreit werden. (Ansonsten kann der popcorn-effekt auftreten).
- Verwenden Sie ausschliesslich Schlaucharmaturen welche für den Einsatz mit Dampfschläuchen geeignet sind. Verwenden Sie ausschliesslich geeignete Schalensarmaturen welche über die Lebensdauer der Schlauchleitung nachgestellt werden können. Klemmschalen sollten vor jedem Einsatz auf Dichtigkeit geprüft werden.
- Vermeiden Sie starkes Abknicken des Schlauches hinter der Armatur
- Lagerung der Schläuche sollte in geeigneten Paletten oder Regalsystemen erfolgen.

Sicherheit

- Arbeiter müssen geeignete Handschuhe, Arbeitstiefel oder Arbeitsschuhe, Arbeitsanzug und Schutzbrille tragen.
- Am Einsatzort für optimale Arbeitsbedingungen sorgen.
- Vor dem Einsatzbeginn die Anschlüsse kontrollieren.
- Vor dem Einsatzbeginn äußere Sichtkontrolle auf dem Schlauch durchführen und auf äußere Schäden durchsuchen.
- Nach den Einsatz sofort den Schlauch vom Druck entlasten.

Periodische Kontrollen des Dampfschlauches

Nach einer bestimmten Laufzeit wird der Schlauch abgenutzt. Wichtig ist dabei, dass man durch periodische Kontrollen die letzte Einsatzzeit feststellt.

Die verantwortliche Person muss die u.g Fehler beachten:

- Blasenbildung auf der Decke
- Einschnitte in der Decke bis auf die EINLAGE
- Dampfleckage an den Kupplungen oder der Schlauchleitung
- Spannungs- und Knickfreiheit
- Nicht über den zulässigen Biegeradius beanspruchen
- Biegungen im Kupplungsbereich vermeiden

Der Schlauch muss sofort unter den Sicherheitsaspekten demontiert und entfernt werden, wenn die o.g Situationen vorkommen. Der Schlauch muss bei dem folgenden Einsatz sorgfältig kontrolliert werden. Die Mängel an dem Schlauch entstehen an den Biegeradien und an den Schlauchstützen. In solchen Situationen, wird für einen Wiedergebrauch der Schlauch an diesen Punkten geschnitten und wieder eingebunden. Beim durchlaufenden Einsatz des Schlauches unter Hochdruck und -temperatur wird der Schlauch härter. Bei der Schlauchkontrolle werden die Schlauchkupplungen entfernt.

Die Eigenschaften des Sattdampfes

Betriebsdruck		Temperatur des Sattdampfes	
kg/cm ²	psi	°C	°F
1	14	99	210
2	28	120	248
3	43	133	272
4	57	143	290
5	71	151	304
6	85	158	316
7	99	164	328
8	114	170	338
9	128	175	348
10	142	179	354
11	156	183	362
12	170	187	368
13	185	191	376
14	199	194	382
15	213	197	386
16	227	200	392
17	241	203	398
18	256	206	403
19	270	209	408
20	284	211	412
22	312	216	421
24	341	221	430
26	369	225	438

Sicherheitshinweis

Dampf hat ein hohes Gefahrenpotential. Freikommender Dampf kann zu schwerwiegenden Verletzungen oder Schäden führen. Verwenden Sie ausschliesslich Dampfschläuche welche für den entsprechenden Einsatz geeignet sind! Befolgen Sie konsequent allgemeine Sicherheitsrichtlinien und gültige Arbeitsschutzbestimmungen.

Waschempfehlung

Wäsche und Sterilisation mit üblichen Zusätzen kann durchgeführt werden. Sterilisation erfolgt bei +120°C (+248°F).

Empfehlung

Nach Gebrauch muss der schlauch entleert werden.

Istruzioni di Sicurezza per Tubi Vapore

Scelta del Tubo Flessibile

- Assicuratevi di scegliere un tubo specificatamente costruito per l'impiego con vapore.
- Il tubo deve riportare l'impiego con vapore mediante una marcatura indelebile sulla copertura e non solo sull'imballo.
- E' necessario inoltre determinare la tipologia dell'applicazione per cui il tubo è stato e realizzato.
 - a) Il tubo viene usato manualmente?
 - b) Qual' è la frequenza di utilizzo prevista?
 - c) Qual' è la pressione di vapore prevista nell'impiego?
 - d) Sono previsti picchi di pressione nell'impianto?
 - e) Qual' è la temperatura del vapore?
 - f) Vapore saturo (contenente umidità) oppure vapore surriscaldato (secco)?
 - g) Quali sono le condizioni dell'ambiente esterno in cui il tubo si trova a lavorare?
- Fate attenzione a perdite, trasudamenti o accumulo di sostanze chimiche che si possono verificare sul tubo,perche sono causa di un rapido deterioramento della copertura.

Montaggio del Tubo Flessibile

- Per non provocare un fenomeno di 'popcorn' nel tubo e necessario di evitare l'uso alternativo dell'acqua e vapore
- Assicuratevi di utilizzare sempre raccordi appositamente progettati per l'impiego con vapore. Questi raccordi sono realizzati in due semi-parti che bloccano il tubo flessibile tramite dei bulloni regolabili per garantire la stessa percentuale di compressione in ogni momento dell'esercizio. Seguire scrupolosamente le istruzioni di montaggio fornite dal produttore di raccordi avendo cura di controllare e mantenere sempre costante la pressione del raccordo sul tubo.
- Evitare raggi di curvatura eccessivi nella zona del tubo flessibile vicina al raccordo.
- Assicuratevi un idoneo immagazzinamento del tubo al termine dell'impiego, evitando di appendere il tubo su ganci o parti taglienti che possano arrecare danni permanenti alla struttura della tubazione.

Sicurezza

- Fornite agli operatori adeguate protezioni personali, quali guanti e stivali di gomma ed abbigliamento altamente protettivo. Lo scopo è quello di proteggere l'operatore da eventuali rischi derivanti da fuoriuscite del vapore o dell'acqua calda.
- Verificare che la zona di impiego sia libera da eventuali altri rischi o pericoli.
- Controllate ad ogni impiego il serraggio dei bulloni dei raccordi.
- Non lasciare i tubi in pressione se non durante l'impiego. Chudere la pressione a fine impiego contribuisce ad aumentare notevolmente la vita del tubo flessibile.

Manutenzione Periodica ed Ispezione dei Tubi Flessibili

I tubi flessibili per vapore sono soggetti ad un deterioramento nel tempo. E' importante, quindi ispezionare periodicamente i tubi in esercizio e sostituirli immediatamente nel caso non forniscano piu' le garanzie di efficienza richieste. L'operatore dovrà prontamente riconoscere i seguenti sintomi di pericolo:

- Rotture o screpolatura della copertura.
- Tagli nella copertura con evidenza visiva della treccia di rinforzo e conseguenti rischi di corrosione del filo di acciaio..
- Perdite di vapore dai raccordi o lungo il tubo.
- Aree schiacciate o fortemente curvate sul tubo in esercizio.
- Una riduzione nella portata di vapore significa rischio di rigonfiamento del tubo.

Quando si verifica uno di questi fatti, si raccomanda di sostituire il tubo flessibile. Una volta disassemblato il tubo può essere ispezionato e se tutto va bene, nuovamente riassembleto. La maggior parte delle rotture dei tubi per vapore si verifica nella zona della raccordatura.

Caratteristiche Del Vapore Saturo

Pressione d'Esercizio		Tempratura del Vapore Saturo	
kg/cm ²	psi	°C	°F
1	14	99	210
2	28	120	248
3	43	133	272
4	57	143	290
5	71	151	304
6	85	158	316
7	99	164	328
8	114	170	338
9	128	175	348
10	142	179	354
11	156	183	362
12	170	187	368
13	185	191	376
14	199	194	382
15	213	197	386
16	227	200	392
17	241	203	398
18	256	206	403
19	270	209	408
20	284	211	412
22	312	216	421
24	341	221	430
26	369	225	438

Raccomandazioni per la Sicurezza

L'esposizione al vapore e' pericolosa. Se non propriamente controllato il vapore può causare danni a cose, proprietà e persino causare la morte. Risulta pertanto indispensabile una scelta corretta del tipo di tubo più idoneo all'applicazione richiesta. Una corretta scelta del tubo più idoneo contribuisce anche alla sicurezza personale dell'operatore. Fate riferimento alla tabella seguente per meglio identificare il rapporto temperatura / pressione negli utilizzi con vapore.

Sterilizzazione

Può essere lavato internamente con acqua e soda, soluzioni sterilizzanti o vapore alla temperatura massima di +120°C.

Raccomandazioni per L'utilizzo

Si consiglia di svuotare il tubo dopo l'impiego.

Instructions de Sécurité Pour Tuyaux de Vapeur

Choix du tuyau de vapeur

- Assurez-vous que le tuyau de vapeur choisi répond aux besoins de l'utilisation.
- Le marquage qui se trouve sur le tuyau doit contenir des informations descriptives.
- Pour définir le type de service du tuyau de vapeur il faut répondre aux questions ci-dessous:
 - a) Le tuyau sera-t-il manipulé à la main?
 - b) Quelle est la fréquence d'utilisation prévue?
 - c) Quelle est la pression de vapeur?
 - d) Le tuyau subit-il des pointes de pression?
 - e) Quelle est la température de vapeur?
 - f) La vapeur est-elle saturée ou surchauffée?
 - g) Le tuyau subit-il des contraintes extérieures?
- Par exemple les matières à base chimique et les dérivés de pétrole à effet corrosif causeront des dégradations sur la surface externe du tuyau.

Utilisation du tuyau

- Il est nécessaire d'éviter le fonctionnement alternatif du tuyau en eau et en vapeur qui cause un phénomène de 'pop corn'.
- Contrôler la conformité des raccords au tuyau de vapeur. Pour assurer le fonctionnement correcte des raccords pendant la vie du tuyau, utiliser des raccords avec colliers de serrage qui pourront être resserrés. Lorsque vous faites l'assemblage conformez-vous aux instructions du producteur de raccord. A chaque utilisation contrôlez la tenue des raccords.
- Eviter un cintrage excessif du tuyau dans les zones proches des raccords.
- Quand le tuyau de vapeur n'est pas utilisé, conservez-le dans des conditions de stockage convenables. S'il est enroulé sur un touret adapté, les dommages dus au stockage seront minimisés. N'accrochez pas le tuyau à un crochet, un clou ou un objet qui pourrait l'endommager.

Sécurité

- La personne qui utilise le tuyau de vapeur, doit utiliser des bottes en caoutchouc, des vêtements de sécurité, des gants et des lunettes. Le but étant de se protéger des brûlures lors de l'utilisation.
- L'espace de travail doit être dégagé.
- A chaque utilisation contrôler la fixation des raccords.
- Lorsque le tuyau n'est pas en service, il faut couper la vapeur.

Entretien périodique et contrôles de tuyau de vapeur

- Les tuyaux de vapeur se détériorent dans le temps. Il est important de contrôler continuellement le tuyau afin d'évaluer les dégradations qui peuvent affecter la sécurité d'utilisation. Les utilisateurs doivent donc faire attention aux signes ci-dessous :
- Les gonflements et les craquelures à la surface du tuyau.
- Les déchirures à la surface du tuyau qui font apparaître le renforcement.
- Une fuite de vapeur auprès du raccord ou le long du tuyau.
- Les écrasements ou les cassures qui ont pu éventuellement endommager le tuyau.
- Les réductions de débit de vapeur sont signe de gonflement du tube interne du tuyau.
- Lorsque vous rencontrez un des signes ci-dessus, le tuyau de vapeur doit être immédiatement mis hors service. Le tuyau mis hors service ne doit pas être utilisé sans être soumis à un contrôle attentif. Les tuyaux de vapeur se détériorent fréquemment au niveau des raccords. Si tel est le cas, couper la zone endommagée et fixer un nouveau raccord. Si le tuyau de vapeur fonctionne continuellement sous haute pression et chaleur importante, il faut contrôler périodiquement si le tube interne du tuyau se durcit. Souvent pour contrôler le tuyau, il faut démonter les raccords.

Propriétés vapeur saturée

Pression de travail		Chaleur de la vapeur saturée	
kg/cm ²	psi	°C	°F
1	14	99	210
2	28	120	248
3	43	133	272
4	57	143	290
5	71	151	304
6	85	158	316
7	99	164	328
8	114	170	338
9	128	175	348
10	142	179	354
11	156	183	362
12	170	187	368
13	185	191	376
14	199	194	382
15	213	197	386
16	227	200	392
17	241	203	398
18	256	206	403
19	270	209	408
20	284	211	412
22	312	216	421
24	341	221	430
26	369	225	438

Avertissement de sécurité

Le contact avec la vapeur est dangereux. Si elle n'est pas transportée convenablement, la vapeur peut causer des dommages, des blessures graves et la mort. La sélection d'un mauvais tuyau de vapeur peut causer des blessures mortelles. L'utilisation correcte du tuyau, le stockage et les contrôles augmenteront la sécurité de la personne qui utilise le tuyau. Les informations de suggestion ci-dessous pour les espaces d'utilisation, ont été préparées à fin de vous aider.

Nettoyage

Le tuyau de vapeur doit être nettoyé avec des détergents convenables ou pour la stérilisation une vapeur propre à +120°C (+248°F) peut être appliquée brièvement.

Suggestions

Après l'utilisation l'intérieur du tuyau doit être laissé sec et propre.

Hot Air Blower

Heißluft- Kompressor

Aria Calda

Air Chaud

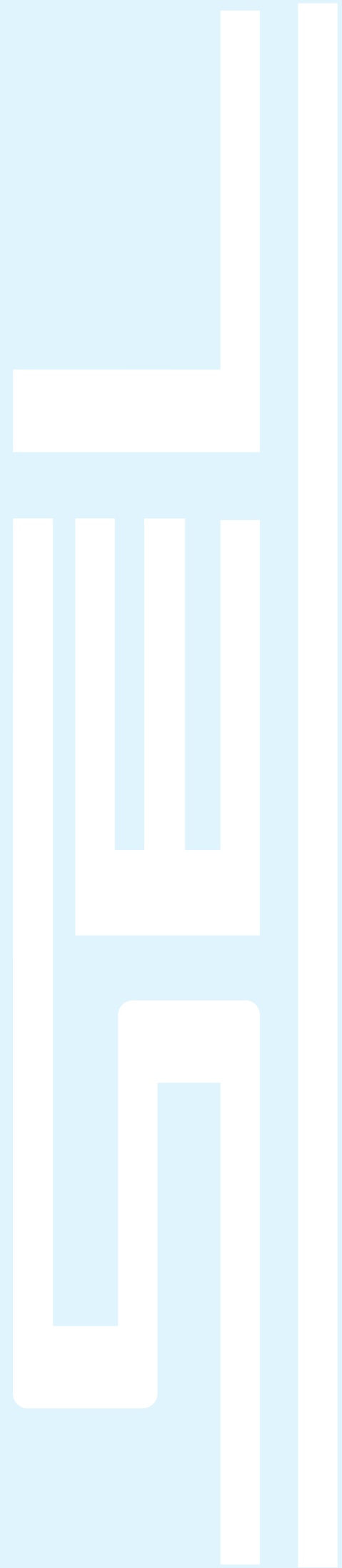

Hot Air Blower



TUBE : HEAT RESISTANT WHITE EPDM RUBBER.
 REINFORCEMENT : HIGH TENSILE SYNTHETIC TEXTILE.
 COVER : ABRASION, OZONE AND WEATHER RESISTANT EPDM RUBBER.
 APPLICATION : TRANSFER OF HOT AND DRY AIR FROM COMPRESSOR TO TANK TRUCK.



SEELE : HITZEBESTÄNDIGER EPDM GUMMI, WEISS.
 EINLAGE : HOCHZUGFESTE SYNTHETISCHE TEXTILEINLAGE.
 DECKE : ABRIEFEST, OZON- UND WETTERBESTÄNDIGER EPDM GUMMI.
 ANWENDUNG : GEEIGNET ALS KOMPRESSORSCHLAUCH ZUR BEFÖRDERUNG VON HEISS- UND TROCKENLUFT.



SOTTOSTRATO : GOMMA IN EPDM BIANCA RESISTENTE AL CALORE.
 RINFORZO : INSERZIONI TESSILI AD ALTA TENACITÀ.
 COPERTURA : GOMMA IN EPDM, RESISTENTE ALL'ABRASIONE, ALL'OZONO ED AGLI AGENTI ATMOSFERICI.
 IMPIEGO : PER MANDATA D'ARIA CALDA SECCA DAL COMPRESSORE ALLA CISTERNA DEL CAMION.



TUBE : CAOUTCHOUC EPDM BLANC, RESISTANT A LA CHALEUR.
 RENFORCEMENT : INSERTION TEXTILE HAUTE TENACITE.
 REVETEMENT : CAOUTCHOUC EPDM, RESISTANT A L'ABRASION, A L'OZONE ET AUX AGENTS ATMOSPHERIQUES.
 APPLICATION : POUR LE TRANSFERT DE L'AIR CHAUD ET SEC, ENTRE LES COMPRESSEURS ET LES CITERNES DE CAMIONS.

ID		OD		WP		BP		W	L
inch	mm	mm	mm	bar	psi	bar	psi	g/m	m
1"	25.4	39		10	145	30	435	825	40-46-61
1 1/4"	32	46		10	145	30	435	995	40-46-61
1 1/2"	38	54		10	145	30	435	1405	40-46-61
2"	50.8	68		10	145	30	435	1955	40-46-61
2 1/2"	63.5	81		10	145	30	435	2390	40-46-61
3"	76.2	94		10	145	30	435	2810	40-46-61
4"	101.6	120		10	145	30	435	3851	40-46-61



-40°C / +200°C INTERMITTENT TO 240 °C
 -40°F / +392°F INTERMITTENT TO 464 °F

MARKING / BESCHRIFTUNG / MARCATURA / MARQUAGE: **TRANSFER TAPE OR EMBOSSED**

SEL ALIZE 200 °C HOT AIR BLOWER HOSE - W.P. 10 Bar (145 PSI)

NORMS NORMEN NORME NORMES	ISO 1307	COLOUR FARBEN COLORI COULEUR	
------------------------------------	----------	---------------------------------------	--

Hot Air Blower S&D



TUBE : HEAT RESISTANT WHITE EPDM RUBBER.
 REINFORCEMENT : HIGH TENSILE SYNTHETIC TEXTILE AND STEEL WIRE HELIX.
 COVER : ABRASION, OZONE AND WEATHER RESISTANT EPDM RUBBER.
 APPLICATION : TRANSFER OF HOT AND DRY AIR FROM COMPRESSOR TO TANK TRUCK. ESPECIALLY WHERE REDUCED BENDING RADIUS IS REQUIRED.



SEELE : HITZEBESTÄNDIGER EPDM GUMMI, WEISS.
 EINLAGE : HOCHZUGFESTE SYNTHETISCHE TEXTILEINLAGE UND STAHLDRAHTSPIRALE.
 DECKE : ABRIEFEST, OZON- UND WETTERBESTÄNDIGER EPDM GUMMI.
 ANWENDUNG : GEEIGNET ALS KOMPRESSORSCHLAUCH ZUR BEFÖRDERUNG VON HEISS- UND TROCKENLUFT MIT EINEM SEHR GERINGEN BIEGERADIUS.



SOTTOSTRATO : GOMMA IN EPDM BIANCA RESISTENTE AL CALORE.
 RINFORZO : INSERZIONI TESSILI AD ALTA TENACITÀ CON SPIRALE D'ACCIAIO INCORPORATA.
 COPERTURA : GOMMA IN EPDM, RESISTENTE ALL'ABRASIONE, ALL'OZONO ED AGLI AGENTI ATMOSFERICI.
 IMPIEGO : PER MANDATA D'ARIA CALDA SECCA DAL COMPRESSORE ALLA CISTERNA DEL CAMION. SPECIALMENTE DA UTILIZZARE DOVE RICHIESTI RAGGI DI CURVATURA RIDOTTI.



TUBE : CAOUTCHOUC EPDM BLANC, RESISTANT A LA CHALEUR.
 RENFORCEMENT : INSERTION TEXTILE HAUTE TENACITE ET SPIRALE EN ACIER NOYEE.
 REVETEMENT : CAOUTCHOUC EPDM, RESISTANT A L'ABRASION, A L'OZONE ET AUX AGENTS ATMOSPHERIQUES.
 APPLICATION : POUR LE TRANSFERT DE L'AIR CHAUD ET SEC, ENTRE LES COMPRESSEURS ET LES CITERNES DE CAMIONS. EN PARTICULIER LA OU UN RAYON DE COURBURE REDUIT EST DEMANDE.

ID		OD		WP		BP		VACUUM	BR/r	W	L
inch	mm	mm	mm	bar	psi	bar	psi	bar	mm	g/m	m
1"	25.4	36		10	145	30	435	-0.92	55	646	40-46-61
1 1/4"	32	42		10	145	30	435	-0.92	70	787	40-46-61
1 1/2"	38	50		10	145	30	435	-0.92	90	1290	40-46-61
2"	50.8	64		10	145	30	435	-0.92	150	1765	40-46-61
2 1/2"	63.5	78		10	145	30	435	-0.92	200	2385	40-46-61
3"	76.2	91		10	145	30	435	-0.92	250	2815	40-46-61
4"	101.6	116		10	145	30	435	-0.92	460	3675	40-46-61



-40 °C / +200 °C INTERMITTENT TO 240 °C
 -40 °F / +392 °F INTERMITTENT TO 464 °F

MARKING / BESCHRIFTUNG / MARCATURA / MARQUAGE: **TRANSFER TAPE OR EMBOSSED**

SEL ALIZE SD 200 °C HOT AIR BLOWER S/D HOSE - W.P. 10 Bar (145 PSI)

NORMS NORMEN NORME NORMES	ISO 1307	COLOUR FARBEN COLORI COULEUR	
------------------------------------	----------	---------------------------------------	--

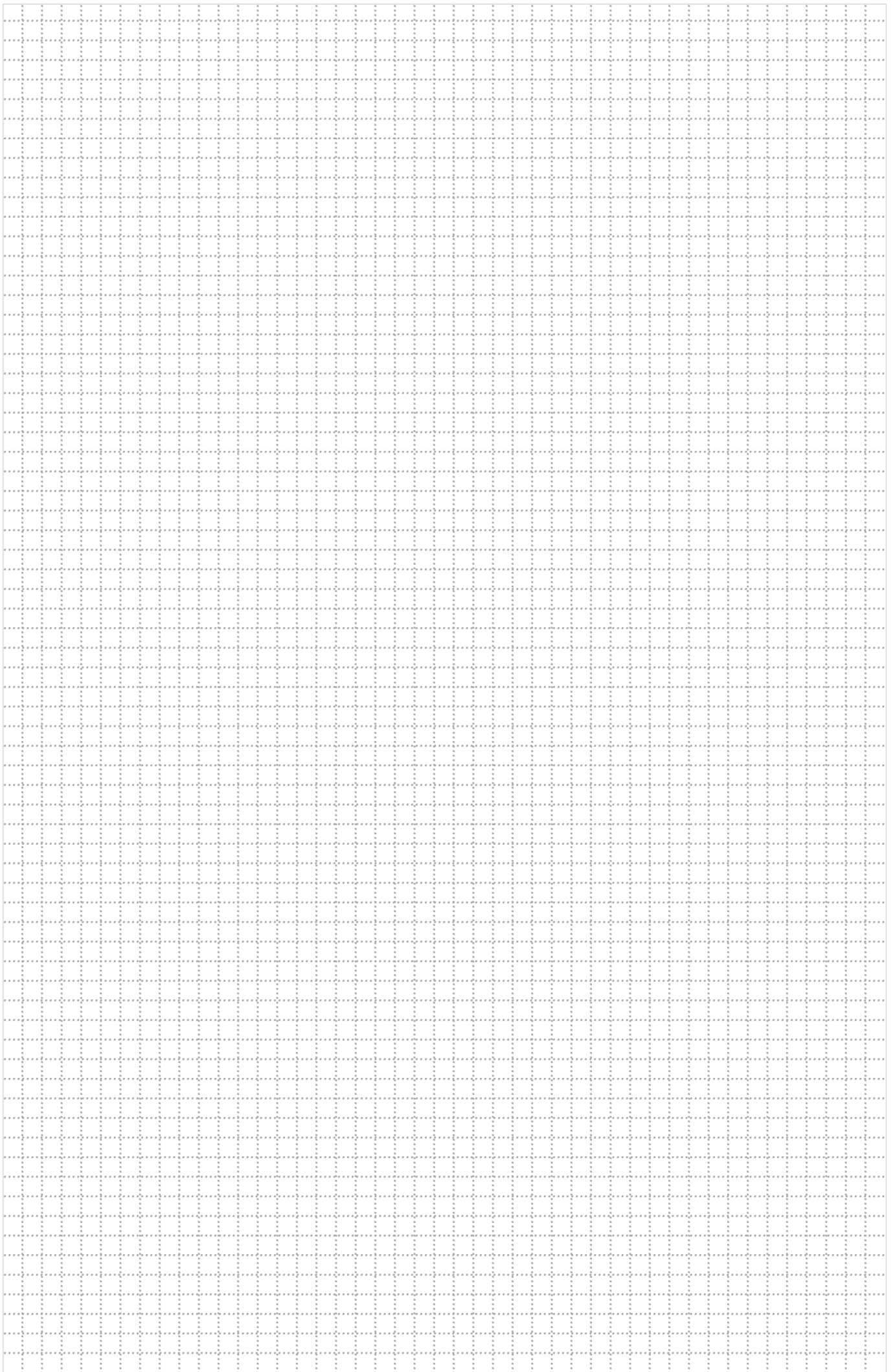

Material Handling

Abriebfeste Schläuche

Prodotti Abrasivi

Produits Abrasifs

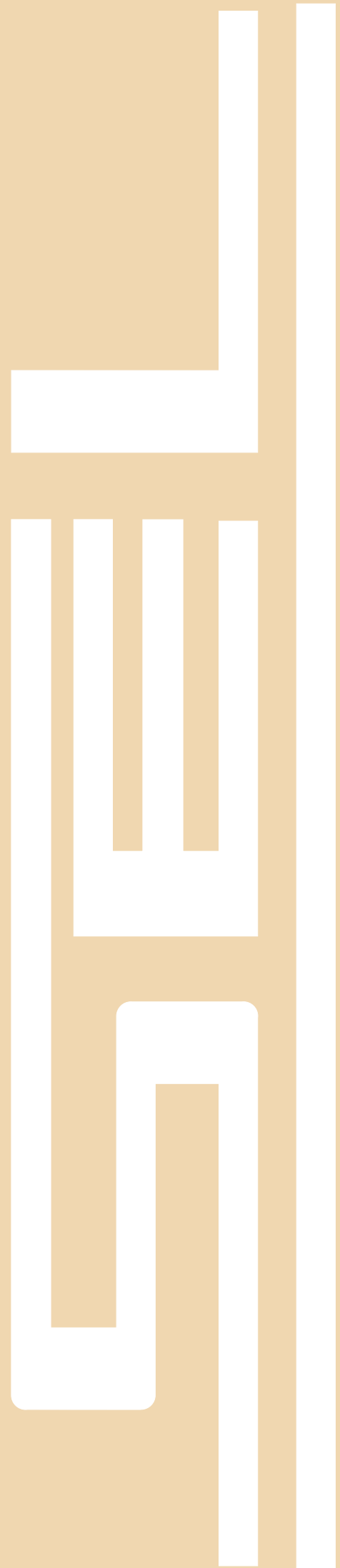

Sandblast

60mm³



TUBE : ABRASION RESISTANT, ANTISTATIC NATURAL RUBBER.
 REINFORCEMENT : HIGH TENSILE SYNTHETIC TEXTILE AND ANTISTATIC COPPER WIRE.
 COVER : ABRASION, OZONE AND WEATHER RESISTANT PIN-PRICKED NATURAL AND SYNTHETIC RUBBER.
 APPLICATION : FOR CLEANING AND BLASTING METAL, STONE AND CONCRETE SURFACES.



SEELE : HOCH ABRIEBFEST, LEITFÄHIG, NATURGUMMI.
 EINLAGE : HOCHZUGFESTE SYNTHETISCHE TEXTILEINLAGE UND ANTISTATISCHER KUPFERLITZE.
 DECKE : OZON- UND WITTERUNGSBESTÄNDIGER, ABRIEBSFESTER, SPEZIELLER NATUR - SYNTHETISCHER GUMMI, GEPRICKT
 ANWENDUNG : ZUR REINIGUNG UND STRAHLEN VON METAL-, STEIN- UND BETON OBERFLÄCHEN



SOTTOSTRATO : GOMMA NATURALE ANTISTATICA, RESISTENTE ALL'ABRASIONE.
 RINFORZO : INSERZIONI TESSILI AD ALTA TENACITÀ CON CORDICELLA DI RAME ANTISTATICA.
 COPERTURA : GOMMA NATURALE E SINTETICA MICRO-FORATA, RESISTENTE ALL'ABRASIONE, ALL'OZONO ED AGLI AGENTI ATMOSFERICI.
 IMPIEGO : PER MANDATA DI MATERIALI ABRASIVI NEGLI IMPIANTI DI SABBIA TURA E GRANIGLIA.



TUBE : CAOUTCHOUC NATUREL CONDUCTEUR, RESISTANT A L'ABRASION.
 RENFORCEMENT : NSERTION TEXTILE HAUTE TENACITE ET FIL DE MASSE ANTISTATIQUE.
 REVETEMENT : CAOUTCHOUC SYNTHETIQUE ET NATUREL, MICROPERFORE, RESISTANT A L'ABRASION, A L'OZONE ET AUX AGENTS ATMOSPHERIQUES.
 APPLICATION : UTILISE DANS LES MACHINES DE SABLAGE POUR NETTOYER LES SURFACES METALLIQUES, FAÇADES ETC.

ID		OD		WP		BP		BR/r	W	L
inch	mm	mm	mm	bar	psi	bar	psi	mm	g/m	m
1/2"	12.7	25	12	174	36	522	125	414	40-46-61	
1/2"	12.7	27	12	174	36	522	125	495	40-46-61	
5/8"	16	28	12	174	36	522	150	476	40-46-61	
5/8"	16	30	12	174	36	522	150	578	40-46-61	
3/4"	19	30	12	174	36	522	190	486	40-46-61	
3/4"	19	31	12	174	36	522	190	530	40-46-61	
3/4"	19	33	12	174	36	522	190	653	40-46-61	
1"	25.4	39	12	174	36	522	250	813	40-46-61	
1 1/4"	32	48	12	174	36	522	320	1160	40-46-61	
1 1/2"	38	54	12	174	36	522	380	1337	40-46-61	
1 1/2"	38	56	12	174	36	522	380	1531	40-46-61	
1 3/4"	44.5	60	12	174	36	522	445	1468	40-46-61	
1 3/4"	44.5	63	12	174	36	522	445	1820	40-46-61	
2"	50.8	69	12	174	36	522	500	2030	40-46-61	
2"	50.8	73	12	174	36	522	500	2484	40-46-61	
2 1/2"	63.5	82	12	174	36	522	630	2626	40-46-61	
3"	76.2	96	12	174	36	522	760	3090	40-46-61	
4"	101.6	122	12	174	36	522	1000	4220	40-46-61	



-40°C / + 70°C
 -40°F / +158°F

MARKING / BESCHRIFTUNG / MARCATURA / MARQUAGE: **TRANSFER TAPE OR EMBOSSED**



NORMS NORMEN NORME NORMES	TS 5928 EN ISO 3861 EN ISO 3861 ISO 1307	COLOUR FARBEN COLORI COULEUR	
------------------------------------	--	---------------------------------------	--



Sandblast

35mm³



TUBE : ABRASION RESISTANT, ANTISTATIC NATURAL RUBBER.
 REINFORCEMENT : HIGH TENSILE SYNTHETIC TEXTILE AND ANTISTATIC COPPER WIRE.
 COVER : ABRASION, OZONE AND WEATHER RESISTANT PIN-PRICKED NATURAL AND SYNTHETIC RUBBER.
 APPLICATION : FOR CLEANING AND BLASTING METAL, STONE AND CONCRETE SURFACES.



SEELE : HOCH ABRIEBFEST, LEITFÄHIG, NATURGUMMI.
 EINLAGE : HOCHZUGFESTE SYNTHETISCHE TEXTILEINLAGE UND ANTISTATISCHER KUPFERLITZE.
 DECKE : OZON- UND WITTERUNGSBESTÄNDIGER, ABRIEBSFESTER, SPEZIELLER NATUR - SYNTHETISCHER GUMMI, GEPRICKT.
 ANWENDUNG : ZUR REINIGUNG UND STRAHLEN VON METAL-, STEIN- UND BETONBEREICHEN



SOTTOSTRATO : GOMMA NATURALE ANTISTATICA, RESISTENTE ALL'ABRASIONE.
 RINFORZO : INSERZIONI TESSILI AD ALTA TENACITÀ CON CORDICELLA DI RAME ANTISTATICA.
 COPERTURA : GOMMA NATURALE E SINTETICA MICRO-FORATA, RESISTENTE ALL'ABRASIONE, ALL'OZONO ED AGLI AGENTI ATMOSFERICI.
 IMPIEGO : PER MANDATA DI MATERIALI ABRASIVI NEGLI IMPIANTI DI SABBIAURA E GRANIGLIA.



TUBE : CAOUTCHOUC NATUREL CONDUCTEUR, RESISTANT A L'ABRASION.
 RENFORCEMENT : INSERTION TEXTILE HAUTE TENACITE ET FIL DE MASSE ANTISTATIQUE.
 REVETEMENT : CAOUTCHOUC SYNTHETIQUE ET NATUREL, MICROPERFORE, RESISTANT A L'ABRASION, A L'OZONE ET AUX AGENTS ATMOSPHERIQUES.
 APPLICATION : UTILISE DANS LES MACHINES DE SABLAGE POUR NETTOYER LES SURFACES METALLIQUES, FAÇADES ETC.

ID		OD		WP		BP		BR/r	W	L
inch	mm	mm	mm	bar	psi	bar	psi	mm	g/m	m
1/2"	12.7	25	12	174	36	522	125	405	40-46-61	
1/2"	12.7	27	12	174	36	522	125	490	40-46-61	
5/8"	16	28	12	174	36	522	150	471	40-46-61	
5/8"	16	30	12	174	36	522	150	571	40-46-61	
3/4"	19	30	12	174	36	522	190	480	40-46-61	
3/4"	19	31	12	174	36	522	190	525	40-46-61	
3/4"	19	33	12	174	36	522	190	647	40-46-61	
1"	25.4	39	12	174	36	522	250	806	40-46-61	
1 1/4"	32	48	12	174	36	522	320	1150	40-46-61	
1 1/2"	38	54	12	174	36	522	380	1330	40-46-61	
1 1/2"	38	56	12	174	36	522	380	1525	40-46-61	
1 3/4"	44.5	60	12	174	36	522	445	1457	40-46-61	
1 3/4"	44.5	63	12	174	36	522	445	1813	40-46-61	
2"	50.8	69	12	174	36	522	500	2023	40-46-61	
2"	50.8	73	12	174	36	522	500	2477	40-46-61	
2 1/2"	63.5	82	12	174	36	522	630	2620	40-46-61	
3"	76.2	96	12	174	36	522	760	3080	40-46-61	
4"	101.6	122	12	174	36	522	1000	4210	40-46-61	



-40°C / + 70°C
 -40°F / +158°F



MARKING / BESCHRIFTUNG / MARCATURA / MARQUAGE: **TRANSFER TAPE OR EMBOSSED**



NORMS NORMEN NORME NORMES	EXCEEDS TS 5928 EN ISO 3861 EXCEEDS EN ISO 3861 ISO 1307	COLOUR FARBEN COLORI COULEUR	
------------------------------------	--	---------------------------------------	--

Sandblast 2 Ply

60mm³



TUBE : ABRASION RESISTANT, ANTISTATIC NATURAL RUBBER.
 REINFORCEMENT : HIGH TENSILE SYNTHETIC TEXTILE
 COVER : ABRASION, OZONE AND WEATHER RESISTANT PIN-PRICKED NATURAL AND SYNTHETIC RUBBER.
 APPLICATION : FOR CLEANING AND BLASTING METAL, STONE AND CONCRETE SURFACES.



SEELE : HOCH ABRIEBFEST, LEITFÄHIG, NATURGUMMI.
 EINLAGE : HOCHZUGFESTE SYNTHETISCHE TEXTILEINLAGE
 DECKE : OZON- UND WITTERUNGSBESTÄNDIGER, ABRIEBSFESTER, SPEZIELLER NATUR - SYNTHETISCHER GUMMI, GEPRICKT
 ANWENDUNG : ZUR REINIGUNG UND STRAHLEN VON METAL-, STEIN- UND BETONBEREICHEN



SOTTOSTRATO : GOMMA NATURALE ANTISTATICA, RESISTENTE ALL'ABRASIONE.
 RINFORZO : INSERZIONI TESSILI AD ALTA TENACITÀ
 COPERTURA : GOMMA NATURALE E SINTETICA MICRO-FORATA, RESISTENTE ALL'ABRASIONE, ALL'OZONO ED AGLI AGENTI ATMOSFERICI.
 IMPIEGO : PER MANDATA DI MATERIALI ABRASIVI NEGLI IMPIANTI DI SABBATURA E GRANIGLIA.



TUBE : CAOUTCHOUC NATUREL CONDUCTEUR, RESISTANT A L'ABRASION.
 RENFORCEMENT : INSERTION TEXTILE HAUTE TENACITE.
 REVETEMENT : CAOUTCHOUC SYNTHETIQUE ET NATUREL, MICROPERFORE, RESISTANT A L'ABRASION, A L'OZONE ET AUX AGENTS ATMOSPHERIQUES.
 APPLICATION : UTILISE DANS LES MACHINES DE SABLAGE POUR NETTOYER LES SURFACES METALLIQUES, FAÇADES ETC.

ID		OD		WP		BP		BR/r	W	L
inch	mm	mm	mm	bar	psi	bar	psi	mm	g/m	m
1/2"	12.7	25.4	10	145	30	435	125	445	40-46-61	
1/2"	12.7	26.9	10	145	30	435	125	530	40-46-61	
1/2"	12.7	28.5	10	145	30	435	125	599	40-46-61	
3/4"	19	38	10	145	30	435	190	971	40-46-61	
1"	25.4	47	10	145	30	435	250	1382	40-46-61	
1 1/4"	32	47.6	10	145	30	435	320	1110	40-46-61	
1 1/4"	32	54.7	10	145	30	435	320	1790	40-46-61	
1 1/2"	38	60	10	145	30	435	380	1960	40-46-61	
2"	50.8	73	10	145	30	435	500	2495	40-46-61	

OPTIONS / OPTIONEN / OPZIONI / OPTIONS

Upon Request : 35 mm³
 Nach Anfrage : 35 mm³
 Su Richiesta : 35 mm³
 Sur Demande : 35 mm³



-40°C / + 70°C
 -40°F / +158°F

MARKING / BESCHRIFTUNG / MARCATURA / MARQUAGE: **TRANSFER TAPE OR EMBOSSED**

SEL KUM AMERICA 2 SANDBLAST HOSE - 2 PLY - W.P. 10 Bar (145 PSI)

NORMS NORMEN NORME NORMES	TS 5928 EN ISO 3861 EN ISO 3861 ISO 1307	COLOUR FARBEN COLORI COULEUR	
------------------------------------	--	---------------------------------------	--

Sandblast 4 Ply

60mm³



TUBE : ABRASION RESISTANT, ANTISTATIC NATURAL RUBBER.
 REINFORCEMENT : HIGH TENSILE SYNTHETIC TEXTILE .
 COVER : ABRASION, OZONE AND WEATHER RESISTANT PIN-PRICKED NATURAL AND SYNTHETIC RUBBER.
 APPLICATION : FOR CLEANING AND BLASTING METAL, STONE AND CONCRETE SURFACES.



SEELE : HOCH ABRIEBFEST, LEITFÄHIG, NATURGUMMI.
 EINLAGE : HOCHZUGFESTE SYNTHETISCHE TEXTILEINLAGE.
 DECKE : OZON- UND WITTERUNGSBESTÄNDIGER, ABRIEBSFESTER, SPEZIELLER NATUR - SYNTHETISCHER GUMMI, GEPRICKT.
 ANWENDUNG : ZUR REINIGUNG UND STRAHLEN VON METAL-, STEIN- UND BETON OBERFLÄCHEN



SOTTOSTRATO : GOMMA NATURALE ANTISTATICA, RESISTENTE ALL'ABRASIONE.
 RINFORZO : INSERZIONI TESSILI AD ALTA TENACITÀ.
 COPERTURA : GOMMA NATURALE E SINTETICA MICRO-FORATA, RESISTENTE ALL'ABRASIONE, ALL'OZONO ED AGLI AGENTI ATMOSFERICI.
 IMPIEGO : PER MANDATA DI MATERIALI ABRASIVI NEGLI IMPIANTI DI SABBIA TURA E GRANIGLIA.



TUBE : CAOUTCHOUC NATUREL CONDUCTEUR, RESISTANT A L'ABRASION.
 RENFORCEMENT : INSERTION TEXTILE HAUTE TENACITE.
 REVETEMENT : CAOUTCHOUC SYNTHETIQUE ET NATUREL, MICROPERFORE, RESISTANT A L'ABRASION, A L'OZONE ET AUX AGENTS ATMOSPHERIQUES.
 APPLICATION : UTILISE DANS LES MACHINES DE SABLAGE POUR NETTOYER LES SURFACES METALLIQUES, FAÇADES ETC.

ID		OD	WP		BP		BR/r	W	L
inch	mm	mm	bar	psi	bar	psi	mm	g/m	m
1/2"	12.7	27	10	145	30	435	125	542	40-46-61
1/2"	12.7	28.5	10	145	30	435	125	626	40-46-61
3/4"	19	38	10	145	30	435	190	1030	40-46-61
1"	25.4	47.6	10	145	30	435	250	1525	40-46-61
1 1/4"	32	54.7	10	145	30	435	320	1857	40-46-61
1 1/2"	38	60	10	145	30	435	380	1982	40-46-61
2"	50.8	73	10	145	30	435	500	2475	40-46-61

OPTIONS / OPTIONEN / OPZIONI / OPTIONS

Upon Request : 35 mm³

Nach Anfrage : 35 mm³

Su Richiesta : 35 mm³

Sur Demande : 35 mm³



-40°C / + 70°C
 -40°F / +158°F

MARKING / BESCHRIFTUNG / MARCATURA / MARQUAGE: **TRANSFER TAPE OR EMBOSSED**



NORMS NORMEN NORME NORMES	TS 5928 EN ISO 3861 EN ISO 3861 ISO 1307	COLOUR FARBEN COLORI COULEUR	
------------------------------------	--	---------------------------------------	--

Cement Flat



TUBE : ABRASION RESISTANT, ANTISTATIC NATURAL RUBBER.
 REINFORCEMENT : HIGH TENSILE SYNTHETIC TEXTILE.
 COVER : ABRASION, OZONE AND WEATHER RESISTANT NATURAL AND SYNTHETIC RUBBER.
 APPLICATION : FOR DISCHARGE OF DRY CEMENT AND ABRASIVE POWDERS FOR LORRIES AND SILOS.



SEELE : HOCH ABRIEBFEST, LEITFÄHIG, NATURGUMMI.
 EINLAGE : HOCHZUGFESTE SYNTHETISCHE TEXTILEINLAGE.
 DECKE : OZON- UND WITTERUNGSBESTÄNDIGER, ABRIEBSFESTER, SPEZIELLER NATUR - SYNTHETISCHER GUMMI
 ANWENDUNG : ZUR BEFÖRDERUNG VON TROCKENEM ZEMENT UND ABRASIVEN PULVERN, FÜR FAHRZEUGE UND SILOS



SOTTOSTRATO : GOMMA NATURALE ANTISTATICA, RESISTENTE ALL'ABRASIONE.
 RINFORZO : INSERZIONI TESSILI AD ALTA TENACITÀ.
 COPERTURA : GOMMA NATURALE E SINTETICA RESISTENTE ALL'ABRASIONE, ALL'OZONO ED AGLI AGENTI ATMOSFERICI.
 IMPIEGO : PER MANDATA DI POLVERI ABRASIVE DI CEMENTO NEI SILOS, CAMION ETC.



TUBE : CAOUTCHOUC NATUREL CONDUCTEUR, RESISTANT A L'ABRASION.
 RENFORCEMENT : INSERTION TEXTILE HAUTE TENACITE.
 REVETEMENT : CAOUTCHOUC SYNTHETIQUE ET NATUREL, RESISTANT A L'ABRASION, A L'OZONE ET AUX AGENTS ATMOSPHERIQUES.
 APPLICATION : POUR REFOULEMENT DU CIMENT SEC ET DES POUDRES ABRASIVES POUR CAMIONS CITERNES.

ID		OD	WP		BP		W	L
inch	mm	mm	bar	psi	bar	psi	g/m	m
2"	50.8	60.4	5	73	15	218	960	40-46-61
2 1/2"	63.5	73	5	73	15	218	1175	40-46-61
3"	76.2	86	5	73	15	218	1392	40-46-61
3 1/8"	80	90	5	73	15	218	1520	40-46-61
3 1/2"	90	100	5	73	15	218	1770	40-46-61
4"	101.6	112	5	73	15	218	2025	40-46-61
4 5/16"	110	120	5	73	15	218	2095	40-46-61
5"	127	137	5	73	15	218	2405	40-46-61
6"	152.4	164	5	73	15	218	3414	40-46-61
8"	203.2	215	5	73	15	218	4660	20-46



-40°C / + 70°C
 -40°F / +158°F

MARKING / BESCHRIFTUNG / MARCATURA / MARQUAGE: **TRANSFER TAPE OR EMBOSSED**



NORMS NORMEN NORME NORMES	ISO 1307	COLOUR FARBEN COLORI COULEUR	
------------------------------------	----------	---------------------------------------	--

Dry Cement Discharge



TUBE : ABRASION RESISTANT, ANTISTATIC NATURAL RUBBER. AVAILABLE IN 1/8", 3/16", AND 1/4" TUBE THICKNESS.
 REINFORCEMENT : HIGH TENSILE SYNTHETIC TEXTILE.
 COVER : ABRASION, OZONE AND WEATHER RESISTANT NATURAL AND SYNTHETIC RUBBER.
 APPLICATION : FOR THE DISCHARGE OF DRY BULK CEMENT AND OTHER BULK MATERIALS.



SEELE : HOCH ABRIEBFEST, LEITFÄHIG, NATURGUMMI. ERHÄLTICH AUCH IN DEN STÄRKEN VON 1/8", 3/16", UND 1/4"
 EINLAGE : HOCHZUGFESTE SYNTHETISCHE TEXTILEINLAGE.
 DECKE : OZON- UND WITTERUNGBESTÄNDIGER, ABRIEBSFESTER, SPEZIELLER NATUR- SYNTHETISCHER GUMMI.
 ANWENDUNG : ZUR BEFÖRDERUNG VON TROCKENEM ZEMENT UND FÜR ANDERE SCHÜTTGÜTERN.



SOTTOSTRATO : GOMMA NATURALE ANTISTATICA, RESISTENTE ALL'ABRASIONE. DISPONIBILE IN DIAMETRI DI 1/8", 3/16" E 1/4" COME SPESSORE.
 RINFORZO : INSERZIONI TESSILI AD ALTA TENACITÀ.
 COPERTURA : GOMMA NATURALE E SINTETICA RESISTENTE ALL'ABRASIONE, ALL'OZONO ED AGLI AGENTI ATMOSFERICI.
 IMPIEGO : PER MANDATA DI POLVERI ABRASIVE DI CEMENTO PER L'ALTRO MATERIALE ABRASIVO.



TUBE : CAOUTCHOUC NATUREL CONDUCTEUR, RESISTANT A L'ABRASION. TUBES DISPONIBLE EN EPAISSEUR DE 1/8", 3/16" ET 1/4".
 RENFORCEMENT : INSERTION TEXTILE HAUTE TENACITE.
 REVETEMENT : CAOUTCHOUC SYNTHETIQUE ET NATUREL, RESISTANT A L'ABRASION, A L'OZONE ET AUX AGENTS ATMOSPHERIQUES.
 APPLICATION : POUR REFOULEMENT DU CIMENT SEC ET AUTRES MARIERIAUX EN VRAC.

TUBE: 1/18"

ID		OD	WP		BP		W	L
inch	mm	mm	bar	psi	bar	psi	g/m	m
4"	101,6	113	5	75	15	225	2271	40-46-61
5"	127	139	5	75	15	225	2854	40-46-61
6"	152,4	164	5	75	15	225	3425	40-46-61

TUBE: 3/16"

inch	mm	mm	bar	psi	bar	psi	g/m	m
4"	101,6	117	5	75	15	225	2970	40-46-61
5"	127	142	5	75	15	225	3610	40-46-61
6"	152,4	167	5	75	15	225	4375	40-46-61

TUBE: 1/4"

inch	mm	mm	bar	psi	bar	psi	g/m	m
4"	101,6	120	5	75	15	225	3645	40-46-61
5"	127	145	5	75	15	225	4430	40-46-61
6"	152,4	171	5	75	15	225	5400	40-46-61



-40°C / + 70°C
 -40°F / +158°F

MARKING / BESCHRIFTUNG / MARCATURA / MARQUAGE: **TRANSFER TAPE OR EMBOSSED**



NORMS NORMEN NORME NORMES	ISO 1307	COLOUR FARBEN COLORI COULEUR	
------------------------------------	----------	---------------------------------------	--

Cement Discharge



TUBE : ABRASION RESISTANT ANTISTATIC NATURAL RUBBER.
 REINFORCEMENT : HIGH TENSILE SYNTHETIC TEXTILE AND ANTISTATIC COPPER WIRE.
 COVER : ABRASION, OZONE AND WEATHER RESISTANT PIN-PRICKED SPECIAL SYNTHETIC RUBBER.
 APPLICATION : FOR DISCHARGE OF DRY BULK MATERIALS, SAND, GRAVEL, DRY CEMENT ETC.



SEELE : HOCH ABRIEBFEST, LEITFÄHIG, NATURGUMMI.
 EINLAGE : HOCHZUGFESTE SYNTHETISCHE TEXTILEINLAGE UND ANTISTATISCHER KUPFERLITZE.
 DECKE : OZON- UND WITTERUNGSBESTÄNDIGER, ABRIEBSFESTER, SPEZIELLER SYNTHETISCHER GUMMI, GEPRICKT
 ANWENDUNG : ZUR BEFÖRDERUNG VON SCHÜTTGÜTERN, TROCKENEM ZEMENT, SAND, KIES USW.



SOTTOSTRATO : GOMMA NATURALE ANTISTATICA, RESISTENTE ALL'ABRASIONE.
 RINFORZO : INSERZIONI TESSILI AD ALTA TENACITÀ CON CORDICELLA DI RAME ANTISTATICA.
 COPERTURA : GOMMA SPECIALE SINTETICA MICRO-FORATA, RESISTENTE ALL'ABRASIONE, ALL'OZONO ED AGLI AGENTI ATMOSFERICI.
 IMPIEGO : PER MANDATA DI CEMENTO SECCO, SABBIA, GHIAIA, MATERIALI ABRASIVI ETC.



TUBE : CAOUTCHOUC NATUREL CONDUCTEUR, RESISTANT A L'ABRASION.
 RENFORCEMENT : INSERTION TEXTILE HAUTE TENACITE ET FIL DE MASSE ANTISTATIQUE.
 REVETEMENT : CAOUTCHOUC SYNTHETIQUE, MICROPERFORE, RESISTANT A L'ABRASION, A L'OZONE ET AUX AGENTS ATMOSPHERIQUES.
 APPLICATION : POUR REFOULEMENT DU MATERIEL SEC EN VRAC, SABLE, GRANULE, CIMENT SEC ETC.

ID		OD	WP		BP		W	L
inch	mm	mm	bar	psi	bar	psi	g/m	m
1"	25.4	37	10	145	30	435	622	40-46-61
1 1/4"	32	44	10	145	30	435	817	40-46-61
1 1/2"	38	50	10	145	30	435	945	40-46-61
1 3/4"	44.5	58	10	145	30	435	1270	40-46-61
2"	50.8	64.5	10	145	30	435	1421	40-46-61
2 1/2"	63.5	77	10	145	30	435	1733	40-46-61
3"	76.2	90	10	145	30	435	2090	40-46-61
3 1/2"	90	104	10	145	30	435	2564	40-46-61
4"	101.6	118	10	145	30	435	3252	40-46-61
5"	127	146	10	145	30	435	4840	40-46-61
6"	152.4	172	10	145	30	435	6000	40-46-61
8"	203.2	225	10	145	30	435	8705	20-46
10"	254	276	10	145	30	435	11397	25



-40°C / + 70°C
 -40°F / +158°F

MARKING / BESCHRIFTUNG / MARCATURA / MARQUAGE: **TRANSFER TAPE OR EMBOSSED**



NORMS NORMEN NORME NORMES	ISO 1307	COLOUR FARBEN COLORI COULEUR	
------------------------------------	----------	---------------------------------------	--



Cement S&D 5 Bar



TUBE : ABRASION RESISTANT ANTISTATIC NATURAL RUBBER.
 REINFORCEMENT : HIGH TENSILE SYNTHETIC TEXTILE, STEEL WIRE HELIX AND ANTISTATIC COPPER WIRE.
 COVER : ABRASION, OZONE AND WEATHER RESISTANT PIN-PRICKED SPECIAL SYNTHETIC RUBBER.
 APPLICATION : FOR SUCTION AND DISCHARGE OF DRY BULK MATERIALS, SAND, GRAVEL, DRY CEMENT ETC.



SEELE : HOCH ABRIEBFEST, LEITFÄHIG, NATURGUMMI.
 EINLAGE : HOCHZUGFESTE SYNTHETISCHE TEXTILEINLAGE MIT EINER STAHLDRAHTSPIRALE UND ANTISTATISCHER KUPFERLITZE.
 DECKE : OZON- UND WITTERUNGSBESTÄNDIGER, ABRIEBSFESTER, SPEZIELLER SYNTHETISCHER GUMMI, GEPRICKT.
 ANWENDUNG : SAUG - DRUCKSCHLAUCH FÜR SCHÜTTGÜTER, TROCKENEM ZEMENT, SAND, KIES USW.



SOTTOSTRATO : GOMMA NATURALE ANTISTATICA, RESISTENTE ALL'ABRASIONE.
 RINFORZO : INSERZIONI TESSILI AD ALTA TENACITÀ CON SPIRALE D'ACCIAIO CON CORDICELLA DI RAME ANTISTATICA.
 COPERTURA : GOMMA SPECIALE SINTETICA MICRO-FORATA, RESISTENTE ALL'ABRASIONE, ALL'OZONO ED AGLI AGENTI ATMOSFERICI.
 IMPIEGO : PER ASPIRAZIONE E MANDATA DI CEMENTO SECCO, SABBIA, GHIAIA, MATERIALI ABRASIVI ETC.



TUBE : CAOUTCHOUC NATUREL CONDUCTEUR, RESISTANT A L'ABRASION.
 RENFORCEMENT : INSERTION TEXTILE HAUTE TENACITE, SPIRALE EN ACIER ET FIL DE MASSE ANTISTATIQUE.
 REVETEMENT : CAOUTCHOUC SYNTHETIQUE, MICROPERFORE, RESISTANT A L'ABRASION, A L'OZONE ET AUX AGENTS ATMOSPHERIQUES.
 APPLICATION : POUR LA MANUTENTION DE MATERIAUX SECS EN VRAC, SABLE, GRANULE, CIMENT SEC ETC.

ID		OD		WP		BP		VACUUM	BR/r	W	L
inch	mm	mm	bar	psi	bar	psi	bar	mm	g/m	m	
1"	25.4	37	5	73	15	218	-0.92	130	725	40-46-61	
1 1/4"	32	43	5	73	15	218	-0.92	165	868	40-46-61	
1 1/2"	38	50	5	73	15	218	-0.92	200	1205	40-46-61	
2"	50.8	64	5	73	15	218	-0.92	270	1727	40-46-61	
2 1/2"	63.5	77	5	73	15	218	-0.92	325	2113	40-46-61	
3"	76.2	91	5	73	15	218	-0.92	400	2915	40-46-61	
3 1/2"	90	105	5	73	15	218	-0.92	470	3540	40-46-61	
4"	101.6	118	5	73	15	218	-0.92	570	4000	40-46-61	
5"	127	146	5	73	15	218	-0.92	720	6010	40-46-61	
6"	152.4	172	5	73	15	218	-0.92	870	7972	40-46-61	
8"	203.2	227	5	73	15	218	-0.80	1220	12675	30	
10"	254	279	5	73	15	218	-0.80	1630	15760	20	



-40°C / + 70°C
 -40°F / +158°F

MARKING / BESCHRIFTUNG / MARCATURA / MARQUAGE: **TRANSFER TAPE OR EMBOSSED**



CIMENTO SD-5

CEMENT S/D HOSE W.P. 5 Bar (73 PSI)



NORMS
 NORMEN
 NORME
 NORMES

ISO 1307

COLOUR
 FARBEN
 COLORI
 COULEUR



Cement S&D 10 Bar



TUBE : ABRASION RESISTANT ANTISTATIC NATURAL RUBBER.
 REINFORCEMENT : HIGH TENSILE SYNTHETIC TEXTILE, STEEL WIRE HELIX AND ANTISTATIC COPPER WIRE.
 COVER : ABRASION, OZONE AND WEATHER RESISTANT PIN-PRICKED SPECIAL SYNTHETIC RUBBER.
 APPLICATION : FOR SUCTION AND DISCHARGE OF DRY BULK MATERIALS, SAND, GRAVEL, DRY CEMENT ETC.



SEELE : HOCH ABRIEBFEST, LEITFÄHIG, NATURGUMMI.
 EINLAGE : HOCHZUGFESTE SYNTHETISCHE TEXTILEINLAGE MIT EINER STAHLDRAHTSPIRALE UND ANTISTATISCHER KUPFERLITZE.
 DECKE : OZON- UND WITTERUNGSBESTÄNDIGER, ABRIEBFESTER, SPEZIELLER SYNTHETISCHER GUMMI, GEPRICKT.
 ANWENDUNG : SAUG- DRUCKSCHLAUCH FÜR SCHÜTTGÜTER, TROCKENEM ZEMENT, SAND, KIES USW.



SOTTOSTRATO : GOMMA NATURALE ANTISTATICA, RESISTENTE ALL'ABRASIONE.
 RINFORZO : INSERZIONI TESSILI AD ALTA TENACITÀ CON SPIRALE D'ACCIAIO E CORDICELLA DI RAME ANTISTATICA.
 COPERTURA : GOMMA SPECIALE SINTETICA MICRO-FORATA, RESISTENTE ALL'ABRASIONE, ALL'OZONO ED AGLI AGENTI ATMOSFERICI.
 IMPIEGO : PER ASPIRAZIONE E MANDATA DI CEMENTO SECCO, SABBIA, GHIAIA, MATERIALI ABRASIVI ETC.



TUBE : CAOUTCHOUC NATUREL CONDUCTEUR, RESISTANT A L'ABRASION.
 RENFORCEMENT : INSERTION TEXTILE HAUTE TENACITE, SPIRALE EN ACIER ET FIL DE MASSE ANTISTATIQUE.
 REVETEMENT : CAOUTCHOUC SYNTHETIQUE, MICROPERFORE, RESISTANT A L'ABRASION, A L'OZONE ET AUX AGENTS ATMOSPHERIQUES.
 APPLICATION : POUR LA MANUTENTION DE MATERIAUX SECS EN VRAC, SABLE, GRANULE, CIMENT SEC ETC.

ID		OD	WP		BP		VACUUM	BR/r	W	L
inch	mm	mm	bar	psi	bar	psi	bar	mm	g/m	m
1"	25.4	39	10	145	30	435	-0.92	125	880	40-46-61
1 1/4"	32	45	10	145	30	435	-0.92	160	1045	40-46-61
1 1/2"	38	52	10	145	30	435	-0.92	190	1395	40-46-61
2"	50.8	66	10	145	30	435	-0.92	250	1975	40-46-61
2 1/2"	63.5	78.5	10	145	30	435	-0.92	315	2315	40-46-61
3"	76.2	92	10	145	30	435	-0.92	380	3117	40-46-61
3 1/2"	90	107	10	145	30	435	-0.92	450	3760	40-46-61
4"	101.6	120	10	145	30	435	-0.92	550	4550	40-46-61
5"	127	149	10	145	30	435	-0.92	700	6697	40-46-61
6"	152.4	174.5	10	145	30	435	-0.92	850	8807	40-46-61
8"	203.2	229	10	145	30	435	-0.80	1200	13690	30
10"	254	281	10	145	30	435	-0.80	1600	17156	20



-40°C / + 70°C
 -40°F / +158°F

MARKING / BESCHRIFTUNG / MARCATURA / MARQUAGE: **TRANSFER TAPE OR EMBOSSED**

SEL CIMENTO SD-10 CEMENT S/D HOSE W.P. 10 Bar (145 PSI)

NORMS NORMEN NORME NORMES	ISO 1307	COLOUR FARBEN COLORI COULEUR	
------------------------------------	----------	---------------------------------------	--



Cement S&D

CORRUGATED



TUBE : ABRASION RESISTANT ANTISTATIC NATURAL RUBBER.
 REINFORCEMENT : HIGH TENSILE SYNTHETIC TEXTILE, STEEL WIRE HELIX AND ANTISTATIC COPPER WIRE.
 COVER : ABRASION, OZONE AND WEATHER RESISTANT CORRUGATED SPECIAL SYNTHETIC RUBBER.
 APPLICATION : FOR SUCTION AND DISCHARGE OF DRY BULK MATERIALS, SAND, GRAVEL, DRY CEMENT ETC.



SEELE : HOCH ABRIEBFEST, LEITFÄHIG, NATURGUMMI.
 EINLAGE : HOCHZUGFESTE SYNTHETISCHE TEXTILEINLAGE MIT EINER STAHLDRAHTSPIRALE UND ANTISTATISCHER KUPFERLITZE.
 DECKE : OZON- UND WITTERUNGSBESTÄNDIGER, ABRIEBSFESTER, SPEZIELLER SYNTHETISCHER GUMMI, GEWELLT
 ANWENDUNG : SAUG - DRUCKSCHLAUCH FÜR SCHÜTTGÜTER, TROCKENEM ZEMENT, SAND, KIES USW.



SOTTOSTRATO : GOMMA NATURALE ANTISTATICA, RESISTENTE ALL'ABRASIONE.
 RINFORZO : INSERZIONI TESSILI AD ALTA TENACITÀ CON SPIRALE D'ACCIAIO E CORDICELLA DI RAME ANTISTATICA.
 COPERTURA : GOMMA SPECIALE SINTETICA ONDULATA, RESISTENTE ALL'ABRASIONE, ALL'OZONO ED AGLI AGENTI ATMOSFERICI.
 IMPIEGO : PER ASPIRAZIONE E MANDATA DI CEMENTO SECCO, SABBIA, GHIAIA, MATERIALI ABRASIVI ETC.



TUBE : CAOUTCHOUC NATUREL CONDUCTEUR, RESISTANT A L'ABRASION.
 REINFORCEMENT : INSERTION TEXTILE HAUTE TENACITE, SPIRALE EN ACIER ET FIL DE MASSE ANTISTATIQUE.
 REVETEMENT : CAOUTCHOUC SYNTHETIQUE ONDULE, RESISTANT A L'ABRASION, A L'OZONE ET AUX AGENTS ATMOSPHERIQUES.
 APPLICATION : POUR LA MANUTENTION DE MATERIAUX SECS EN VRAC, SABLE, GRANULE, CIMENT SEC ETC.

ID		OD		WP		BP		VACUUM	BR/r	W	L
inch	mm	mm	bar	psi	bar	psi	bar	mm	g/m	m	
1"	25.4	37.5	10	145	30	435	-0.92	85	788	40-46-61	
1 1/4"	32	44	10	145	30	435	-0.92	115	953	40-46-61	
1 1/2"	38	51	10	145	30	435	-0.92	135	1273	40-46-61	
2"	50.8	64.5	10	145	30	435	-0.92	180	1750	40-46-61	
2 1/2"	63.5	77.5	10	145	30	435	-0.92	230	2350	40-46-61	
3"	76.2	90.5	10	145	30	435	-0.92	280	3040	40-46-61	
3 1/2"	90	106	10	145	30	435	-0.92	340	3815	40-46-61	
4"	101.6	119	10	145	30	435	-0.92	400	4610	40-46-61	
5"	127	147	10	145	30	435	-0.92	500	6750	40-46-61	
6"	152.4	173	10	145	30	435	-0.92	630	8860	40-46-61	
8"	203.2	227	10	145	30	435	-0.80	1000	13220	30	
10"	254	279	10	145	30	435	-0.80	1300	17150	20	



-40°C / + 70°C
 -40°F / +158°F

MARKING / BESCHRIFTUNG / MARCATURA / MARQUAGE: **TRANSFER TAPE OR EMBOSSED**



NORMS
 NORMEN
 NORME
 NORMES

ISO 1307

COLOUR
 FARBEN
 COLORI
 COULEUR



Cement S&D



CHANNELED



TUBE : ABRASION RESISTANT ANTISTATIC NATURAL RUBBER.
 REINFORCEMENT : HIGH TENSILE SYNTHETIC TEXTILE, STEEL WIRE HELIX AND ANTISTATIC COPPER WIRE.
 COVER : ABRASION, OZONE AND WEATHER RESISTANT CHANNELED SPECIAL SYNTHETIC RUBBER.
 APPLICATION : FOR SUCTION AND DISCHARGE OF DRY BULK MATERIALS, SAND, GRAVEL, DRY CEMENT ETC.



SEELE : HOCH ABRIEBFEST, LEITFÄHIG, NATURGUMMI.
 EINLAGE : HOCHZUGFESTE SYNTHETISCHE TEXTILEINLAGE MIT EINER STAHLDRAHTSPIRALE UND ANTISTATISCHER KUPFERLITZE.
 DECKE : OZON- UND WITTERUNGSBESTÄNDIGER, ABRIEBFESTER, SPEZIELLER SYNTHETISCHER GUMMI, KORDELGERIPPT
 ANWENDUNG : SAUG - DRUCKSCHLAUCH FÜR SCHÜTTGÜTER, TROCKENEM ZEMENT, SAND, KIES USW.



SOTTOSTRATO : GOMMA NATURALE ANTISTATICA, RESISTENTE ALL'ABRASIONE.
 RINFORZO : INSERZIONI TESSILI AD ALTA TENACITÀ CON SPIRALE D' ACCIAIO E CORDICELLA DI RAME ANTISTATICA.
 COPERTURA : GOMMA SPECIALE SINTETICA GRECATA, RESISTENTE ALL'ABRASIONE, ALL'OZONO ED AGLI AGENTI ATMOSFERICI.
 IMPIEGO : PER ASPIRAZIONE E MANDATA DI CEMENTO SECCO, SABBIA, GHIAIA, MATERIALI ABRASIVI ETC.



TUBE : CAOUTCHOUC NATUREL CONDUCTEUR, RESISTANT A L'ABRASION.
 RENFORCEMENT : INSERTION TEXTILE HAUTE TENACITE, SPIRALE EN ACIER ET FIL DE MASSE ANTISTATIQUE.
 REVETEMENT : CAOUTCHOUC SYNTHETIQUE ASPECT CRENELE, RESISTANT A L'ABRASION, A L'OZONE ET AUX AGENTS ATMOSPHERIQUES.
 APPLICATION : POUR LA MANUTENTION DE MATERIAUX SECS EN VRAC, SABLE, GRANULE, CIMENT SEC ETC.

ID		OD	WP		BP		VACUUM	BR/r	W	L
inch	mm	mm	bar	psi	bar	psi	bar	mm	g/m	m
1"	25.4	36	10	145	30	435	-0.92	80	774	40-46-61
1 1/4"	32	42.5	10	145	30	435	-0.92	100	940	40-46-61
1 1/2"	38	48.4	10	145	30	435	-0.92	120	1090	40-46-61
2"	50.8	62	10	145	30	435	-0.92	160	1611	40-46-61
2 1/2"	63.5	76	10	145	30	435	-0.92	200	2136	40-46-61
3"	76.2	89	10	145	30	435	-0.92	250	2452	40-46-61
3 1/2"	90	104.5	10	145	30	435	-0.92	300	3433	40-46-61
4"	101.6	117.5	10	145	30	435	-0.92	350	4139	40-46-61
5"	127	145.5	10	145	30	435	-0.80	450	6305	40-46-61
6"	152.4	172	10	145	30	435	-0.80	560	8035	40-46-61



-40°C / + 70°C
 -40°F / +158°F

MARKING / BESCHRIFTUNG / MARCATURA / MARQUAGE: **TRANSFER TAPE OR EMBOSSED**

SEL CIMENTO GR CEMENT S/D HOSE W.P. 10 Bar (145 PSI)

NORMS NORMEN NORME NORMES	ISO 1307	COLOUR FARBEN COLORI COULEUR	
------------------------------------	----------	---------------------------------------	--

Concrete Vibration Hose



TUBE : SPECIAL SYNTHETIC RUBBER.
 REINFORCEMENT : HIGH TENSILE SYNTHETIC TEXTILE.
 COVER : ABRASION, OZONE AND WEATHER RESISTANT SPECIAL SYNTHETIC RUBBER.
 APPLICATION : UTILIZED ON SUBMERGED VIBRATORS TO PREVENT AIR BUBBLES IN THE CONCRETE LIQUID PROJECTED BY HAND VIBRATING.



SEELE : SPEZIELLER SYNTHETISCHER GUMMI.
 EINLAGE : HOCHZUGFESTE SYNTHETISCHE TEXTILEINLAGE.
 DECKE : OZON- UND WITTERUNGSBESTÄNDIGER, ABRIEBSFESTER, SPEZIELLER SYNTHETISCHER GUMMI.
 ANWENDUNG : SPEZIELL FÜR TAUCHVIBRATOREN ENTWICKELTER SCHLAUCH ZUR VORBEUGUNG VON LUFTBLÄSCHEN IN INJEKTIONSBETON BEI DER ANWENDUNG.



SOTTOSTRATO : GOMMA SPECIALE SINTETICA.
 RINFORZO : INSERZIONI TESSILI AD ALTA TENACITA.
 COPERTURA : GOMMA SINTETICA RESISTENTE ALL'ABRASIONE, ALL'OZONO E AGENTI ATMOSFERICI.
 IMPIEGO : UTILIZZATO NEI VIBRATORI AD IMMERSIONE PER EVITARE BOLLE D'ARIA NEL LIQUIDO CALCESTRUZZO.



TUBE : CAOUTCHOUC SPECIAL SYNTHETIQUE.
 REINFORCEMENT : INSERTION TEXTILE HAUTE TENACITE.
 REVETEMENT : CAOUTCHOUC SYNTHETIQUE, RESISTANT A L'ABRASION, A L'OZONE ET AUX AGENTS ATMOSPHERIQUES.
 APPLICATION : UTILISE DANS LES VIBREURS A IMMERSION, POUR EMPECHER LES BULLES D'AIR DANS LE BETONE LIQUIDE PROJETE, PAR AIGUILLES VIBRANTES.

ID		OD	WP		BP		W	L
inch	mm	mm	bar	psi	bar	psi	g/m	m
5/8"	16	26	10	145	30	435	512	40-46-61
3/4"	19	30	10	145	30	435	682	40-46-61
7/8"	22	33	10	145	30	435	740	40-46-61
1"	25.4	36	10	145	30	435	812	40-46-61
1"	25.4	39	10	145	30	435	1082	40-46-61
1"	25.4	42	10	145	30	435	1395	40-46-61
1 1/8"	28	40	10	145	30	435	1002	40-46-61
1 1/8"	28	44	10	145	30	435	1460	40-46-61
1 1/4"	32	48	10	145	30	435	1600	40-46-61
	40	54	10	145	30	435	1645	40-46-61
	40	56	10	145	30	435	1930	40-46-61



-40°C / + 70°C
 -40°F / +158°F

MARKING / BESCHRIFTUNG / MARCATURA / MARQUAGE: **TRANSFER TAPE OR EMBOSSED**



NORMS NORMEN NORME NORMES	ISO 1307	COLOUR FARBEN COLORI COULEUR	
------------------------------------	----------	---------------------------------------	--

Bulk Material S&D Hose



TUBE : ABRASION RESISTANT ANTISTATIC NATURAL RUBBER.
 REINFORCEMENT : HIGH TENSILE SYNTHETIC TEXTILE, STEEL WIRE HELIX AND ANTISTATIC COPPER WIRE.
 COVER : ABRASION, OZONE AND WEATHER RESISTANT CORRUGATED SPECIAL SYNTHETIC RUBBER.
 APPLICATION : FOR SUCTION AND DISCHARGE OF DRY BULK MATERIALS, SAND, GRAVEL, DRY CEMENT ETC.



SEELE : HOCH ABRIEBFEST, LEITFÄHIG, NATURGUMMI.
 EINLAGE : HOCHZUGFESTE SYNTHETISCHE TEXTILEINLAGE MIT EINER STAHLDRAHTSPIRALE UND ANTISTATISCHER KUPFERLITZE.
 DECKE : OZON- UND WITTERUNGSBESTÄNDIGER, ABRIEBSFESTER, SPEZIELLER SYNTHETISCHER GUMMI, GEWELLT
 ANWENDUNG : SAUG - DRUCKSCHLAUCH FÜR SCHÜTTGÜTER, TROCKENEM ZEMENT, SAND, KIES USW.



SOTTOSTRATO : GOMMA NATURALE ANTISTATICA, RESISTENTE ALL'ABRASIONE.
 RINFORZO : INSERZIONI TESSILI AD ALTA TENACITÀ CON SPIRALE D'ACCIAIO E CORDICELLA DI RAME ANTISTATICA.
 COPERTURA : GOMMA SPECIALE SINTETICA ONDULATA, RESISTENTE ALL'ABRASIONE, ALL'OZONO ED AGLI AGENTI ATMOSFERICI.
 IMPIEGO : PER ASPIRAZIONE E MANDATA DI CEMENTO SECCO, SABBIA, GHIAIA, MATERIALI ABRASIVI ETC.



TUBE : CAOUTCHOUC NATUREL CONDUCTEUR, RESISTANT A L'ABRASION.
 RENFORCEMENT : INSERTION TEXTILE HAUTE TENACITE, SPIRALE EN ACIER ET FIL DE MASSE ANTISTATIQUE.
 REVETEMENT : CAOUTCHOUC SYNTHETIQUE ONDULE, RESISTANT A L'ABRASION, A L'OZONE ET AUX AGENTS ATMOSPHERIQUES.
 APPLICATION : POUR LA MANUTENTION DE MATERIAUX SECS EN VRAC, SABLE, GRANULE, CIMENT SEC ETC.

ID		OD	WP		BP		VACUUM	BR/r	W	L
inch	mm	mm	bar	psi	bar	psi	bar	mm	g/m	m
3 1/8"	80	113	10	145	30	435	-0.92	350	6584	40-46-61
4"	101.6	133	10	145	30	435	-0.92	500	7663	40-46-61
5"	127	158	10	145	30	435	-0.92	650	9817	40-46-61
6"	152.4	183	10	145	30	435	-0.92	750	12117	40-46-61
8"	203.2	234	10	145	30	435	-0.92	1750	16586	20
10"	254	286	10	145	30	435	-0.92	2000	22175	12
12"	304.8	341	10	145	30	435	-0.92	2500	26518	12

Easily assembled in application lengths.
 Leichtes zusammenbauen in den gewünschten Anwendungslängen.
 Facilmente assemblati nelle lunghezze di applicazione.
 Facile a et équiper dans les longueurs d'utilisation.



-40°C / + 70°C
 -40°F / +158°F

MARKING / BESCHRIFTUNG / MARCATURA / MARQUAGE: **TRANSFER TAPE OR EMBOSSED**



NORMS NORMEN NORME NORMES	ISO 1307	COLOUR FARBEN COLORI COULEUR	
------------------------------------	----------	---------------------------------------	--

FRAME HOSE - COUPLING+GASKETS

CODE	DIAMETER		ØO	ØG	C	B	Ød	Drilling
	mm	Inch	mm	mm	mm	mm	mm	Number
RDSA080001	80	3 1/8	208	160	101	20	18	4
RDSA100001	100	4	230	180	102	20	18	4
RDSA125001	125	5	250	210	112	24	10	8
RDSA150001	150	6	295	240	152	24	22	8
RDSA200001	200	8	352	295	171	26	22	8
RDSA250001	250	10	405	350	186	28	22	12
RDSA300001	300	12	445	400	190	28	22	12

Coupling dimensions according to PN 10-DIN 2576
Material: Aluminium

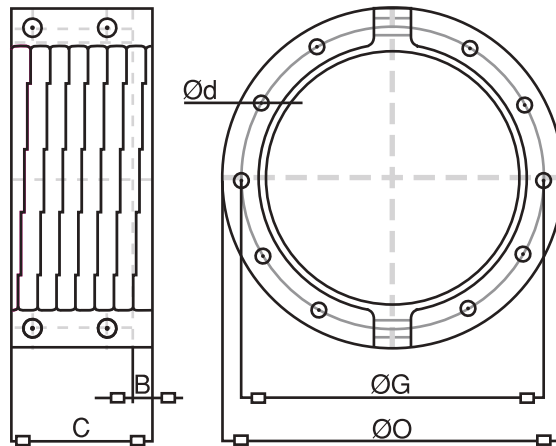

CODE	DIAMETER		ØD	ØD1	ØD2	C	B
	mm	Inch	mm	mm	mm	mm	mm
CONTA08001	80	3 1/8	118	78	75,5	23	3,5
CONTA10001	100	4	138	98	95,5	23	3,5
CONTA12501	125	5	183	123	120	31,5	4
CONTA15001	150	6	208	148	145	31,5	4
CONTA20001	200	8	250	198	195	31,5	4
CONTA25001	250	10	311	248	245	37	4
CONTA30001	300	12	366		292	37	4

Gaskets for FRAME HOSE couplings

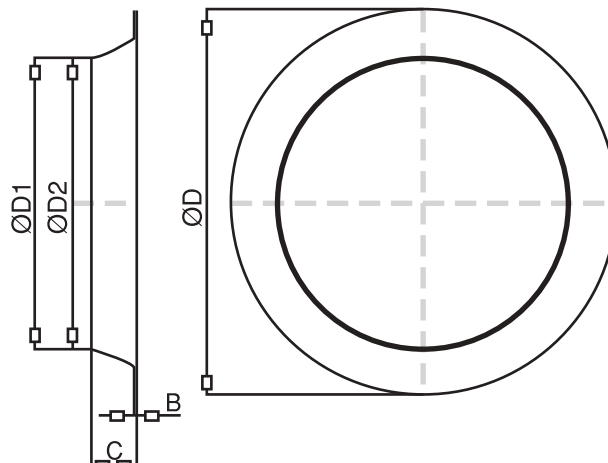

Plaster&Grout Spraying



TUBE : ABRASION RESISTANT ANTISTATIC NATURAL RUBBER.
 REINFORCEMENT : HIGH TENSILE SYNTHETIC TEXTILE AND ANTISTATIC COPPER WIRE.
 COVER : ABRASION, OZONE AND WEATHER RESISTANT PIN-PRICKED SPECIAL SYNTHETIC RUBBER.
 APPLICATION : FOR SPRAYING PLASTER, GROUT, SAND, GYPSUM, READY MIXED CONCRETE.



SEELE : HOCH ABRIEFEST, LEITFÄHIG, NATURGUMMI.
 EINLAGE : HOCHZUGFESTE SYNTHETISCHE TEXTILEINLAGE UND ANTISTATISCHER KUPFERLITZE.
 DECKE : OZON- UND WITTERUNGSBESTÄNDIGER, ABRIEBSFESTER, SPEZIELLER SYNTHETISCHER GUMMI, GEPRICKT.
 ANWENDUNG : DRUCKSCHLAUCH FÜR MÖRTEL, PUTZ, SAND, GIPS UND FRISCHEM BETON.



SOTTOSTRATO : GOMMA NATURALE ANTISTATICA, RESISTENTE ALL'ABRASIONE.
 RINFORZO : INSERZIONI TESSILI AD ALTA TENACITÀ CON CORDICELLA DI RAME ANTISTATICA.
 COPERTURA : GOMMA SPECIALE SINTETICA MICRO-FORATA, RESISTENTE ALL'ABRASIONE, ALL'OZONO ED AGLI AGENTI ATMOSFERICI.
 IMPIEGO : PER MANDATA DI BETONCINO, INTONACO, SABBIA, GESSO E MALTE.



TUBE : CAOUTCHOUC NATUREL CONDUCTEUR, RESISTANT A L'ABRASION.
 RENFORCEMENT : INSERTION TEXTILE HAUTE TENACITE ET FIL DE MASSE ANTISTATIQUE.
 REVETEMENT : CAOUTCHOUC SYNTHETIQUE, MICROPERFORE, RESISTANT A L'ABRASION, A L'OZONE ET AUX AGENTS ATMOSPHERIQUES.
 APPLICATION : POUR LA PROJECTION DU PLATRE, GYPSE, SABLE ET BETON MELANGE.

ID		OD		WP		BP		W	L
inch	mm	mm	bar	psi	bar	psi	g/m	m	
3/4"	19	31	40	580	120	1740	540	40-46-61	
1"	25.4	37	40	580	120	1740	651	40-46-61	
1"	25.4	38	40	580	120	1740	752	40-46-61	
1 3/16"	30	44	40	580	120	1740	953	40-46-61	
1 1/4"	32	46	40	580	120	1740	1026	40-46-61	
1 3/8"	35	49	40	580	120	1740	1104	40-46-61	
1 1/2"	38	54	40	580	120	1740	1426	40-46-61	
1 3/4"	44.5	61	40	580	120	1740	1626	40-46-61	
2"	50.8	68	40	580	120	1740	1961	40-46-61	
2 3/8"	60	80	40	580	120	1740	2722	40-46-61	
2 1/2"	63.5	83.5	40	580	120	1740	2860	40-46-61	
2 5/8"	65	85	40	580	120	1740	2925	40-46-61	
2 3/4"	70	90	40	580	120	1740	2875	40-46-61	
3"	76.2	96.2	40	580	120	1740	3141	40-46-61	
4"	101.6	122	40	580	120	1740	4138	40-46-61	
5"	127	155	40	580	120	1740	6850	40-46-61	



-40°C / + 70°C
 -40°F / +158°F

MARKING / BESCHRIFTUNG / MARCATURA / MARQUAGE: **TRANSFER TAPE OR EMBOSSED**



NORMS NORMEN NORME NORMES	ISO 1307	COLOUR FARBEN COLORI COULEUR	
------------------------------------	----------	---------------------------------------	--



Plaster&Grout Spraying



TUBE : ABRASION RESISTANT ANTISTATIC NATURAL RUBBER.
 REINFORCEMENT : HIGH TENSILE SYNTHETIC TEXTILE AND ANTISTATIC COPPER WIRE.
 COVER : ABRASION, OZONE AND WEATHER RESISTANT PIN-PRICKED SPECIAL SYNTHETIC RUBBER.
 APPLICATION : FOR HIGH PRESSURE SPRAYING PLASTER, GROUT, SAND, GYPSUM, READY MIXED CONCRETE.



SEELE : HOCH ABRIEBFEST, LEITFÄHIG, NATURGUMMI.
 EINLAGE : HOCHZUGFESTE SYNTHETISCHE TEXTILEINLAGE UND ANTISTATISCHER KUPFERLITZE.
 DECKE : OZON- UND WITTERUNGSBESTÄNDIGER, ABRIEBFESTER, SPEZIELLER SYNTHETISCHER GUMMI, GEPRICKT
 ANWENDUNG : HOCHDRUCKSCHLAUCH FÜR MÖRTEL, PUTZ, SAND, GIPS UND FRISCHEM BETON



SOTTOSTRATO : GOMMA NATURALE ANTISTATICA, RESISTENTE ALL'ABRASIONE.
 RINFORZO : INSERZIONI TESSILI AD ALTA TENACITÀ CON CORDICELLA DI RAME ANTISTATICA.
 COPERTURA : GOMMA SPECIALE SINTETICA MICRO-FORATA, RESISTENTE ALL'ABRASIONE, ALL'OZONO ED AGLI AGENTI ATMOSFERICI.
 IMPIEGO : PER MANDATA AD ALTA PRESSIONE DI BETONCINO, INTONACO, SABBIA, GESSO E MALTE.



TUBE : CAOUTCHOUC NATUREL CONDUCTEUR, RESISTANT A L'ABRASION.
 RENFORCEMENT : INSERTION TEXTILE HAUTE TENACITE ET FIL DE MASSE ANTISTATIQUE.
 REVETEMENT : CAOUTCHOUC SYNTHETIQUE, MICROPERFORE, RESISTANT A L'ABRASION, A L'OZONE ET AUX AGENTS ATMOSPHERIQUES.
 APPLICATION : POUR LA PROJECTION A HAUTE PRESSIONE DU PLATRE, GYPSE, SABLE ET BETON MELANGE.

ID		OD	WP		BP		W	L
inch	mm	mm	bar	psi	bar	psi	g/m	m
1"	25.4	42.4	85	1233	178	2581	1025	40-46-61
1 1/4"	32.0	48.8	85	1233	178	2581	1220	40-46-61
1 1/2"	38.0	58.7	85	1233	178	2581	1810	40-46-61
2"	50.8	72.0	85	1233	178	2581	2400	40-46-61
2 1/2"	63.5	86.3	85	1233	178	2581	3010	40-46-61
3"	76.2	99.6	85	1233	178	2581	3650	40-46-61
4"	101.6	126.0	85	1233	178	2581	4735	40-46-61
5"	127.0	153.3	85	1233	178	2581	6375	40-46-61



-40°C / + 70°C
 -40°F / +158°F

MARKING / BESCHRIFTUNG / MARCATURA / MARQUAGE: **TRANSFER TAPE OR EMBOSSED**

SEL SIVA 85 PLASTER & GROUT SPRAYING HOSE W.P. * Bar (**** PSI)**

NORMS NORMEN NORME NORMES	ISO 1307	COLOUR FARBEN COLORI COULEUR	
------------------------------------	----------	---------------------------------------	--

Steel Wire Reinforced Concrete Pumping



TUBE : ABRASION RESISTANT ANTISTATIC NATURAL AND CBR RUBBER.
 REINFORCEMENT : HIGH TENSILE STEEL CORDS.
 COVER : ABRASION, OZONE AND WEATHER RESISTANT PIN-PRICKED SPECIAL SYNTHETIC RUBBER.
 APPLICATION : FOR HIGH PRESSURE CONCRETE PUMPING AND PLACING USED IN THE END OF BOOM OF CONCRETE PUMP.



SEELE : HOCH ABRIEFEST, LEITFÄHIG, NATUR- UND CBR GUMMI.
 EINLAGE : HOCHZUGFESTE SYNTHETISCHE TEXTILEINLAGEN UND STAHLDRAHTSPIRALEN.
 DECKE : OZON- UND WITTERUNGSBESTÄNDIGER, ABRIEBSFESTER, SPEZIELLER SYNTHETISCHER GUMMI, GEPRICKT.
 ANWENDUNG : HOCHDRUCKSCHLAUCH FÜR BETONPUMPEN UND BETONPUMPFahrzeuge.



SOTTOSTRATO : GOMMA SPECIALE NATURALE/ CBR ANTISTATICA, RESISTENTE ALL'ABRASIONE.
 RINFORZO : CORDINE D'ACCIAIO AD ALTA TENACITÀ.
 COPERTURA : GOMMA SPECIALE SINTETICA MICRO-FORATA, RESISTENTE ALL'ABRASIONE, ALL'OZONO ED AGLI AGENTI ATMOSFERICI.
 IMPIEGO : PER POMPAGGIO E DIFFUSIONE DI CALCESTRUZZO AD ALTA PRESSIONE.



TUBE : CAOUTCHOUC NATUREL ET CBR CONDUCTEUR, RESISTANT A L'ABRASION.
 RENFORCEMENT : NAPPES METALLIQUES HAUTE TENACITE.
 REVETEMENT : CAOUTCHOUC SYNTHETIQUE, MICROPERFORE, RESISTANT A L'ABRASION, A L'OZONE ET AUX AGENTS ATMOSPERIQUES.
 APPLICATION : POUR POMPER ET PLACER LE BETON A HAUTE PRESSIONE UTILISE EN BOUT DE FLECHE DE LA POMPE A BETON.

ID		OD	WP		BP		BR/r	W	L
inch	mm	mm	bar	psi	bar	psi	mm	g/m	m
2"	50.8	70	85	1232	200	2900	275	3030	40-61
2 1/2"	63.5	88	85	1232	200	2900	300	4480	40-61
3"	76.2	102	85	1232	200	2900	350	5460	40-61
4"	101.6	130	85	1232	200	2900	400	8460	40-61
5"	127	155	85	1232	200	2900	500	9625	40-61
6"	152.4	180	85	1232	140	2030	650	10990	40-61

OPTIONS / OPTIONEN / OPZIONI / OPTIONS

- Upon Request : Supplied with swaged on SEL hardened couplings.
- Auf Anfrage : Kann mit gehärteten eingepresten SEL Kupplungen geliefert werden.
- Su Richiesta : Fornito con raccordi pressati SEL cementati.
- Sur Demande : Fourni avec des raccords sertis SEL cementes.



-40°C / + 70°C
 -40°F / +158°F

MARKING / BESCHRIFTUNG / MARCATURA / MARQUAGE: **TRANSFER TAPE OR EMBOSSED**



NORMS NORMEN NORME NORMES	ISO 1307	COLOUR FARBEN COLORI COULEUR	
------------------------------------	----------	---------------------------------------	--



Steel Wire Reinforced Concrete Pumping

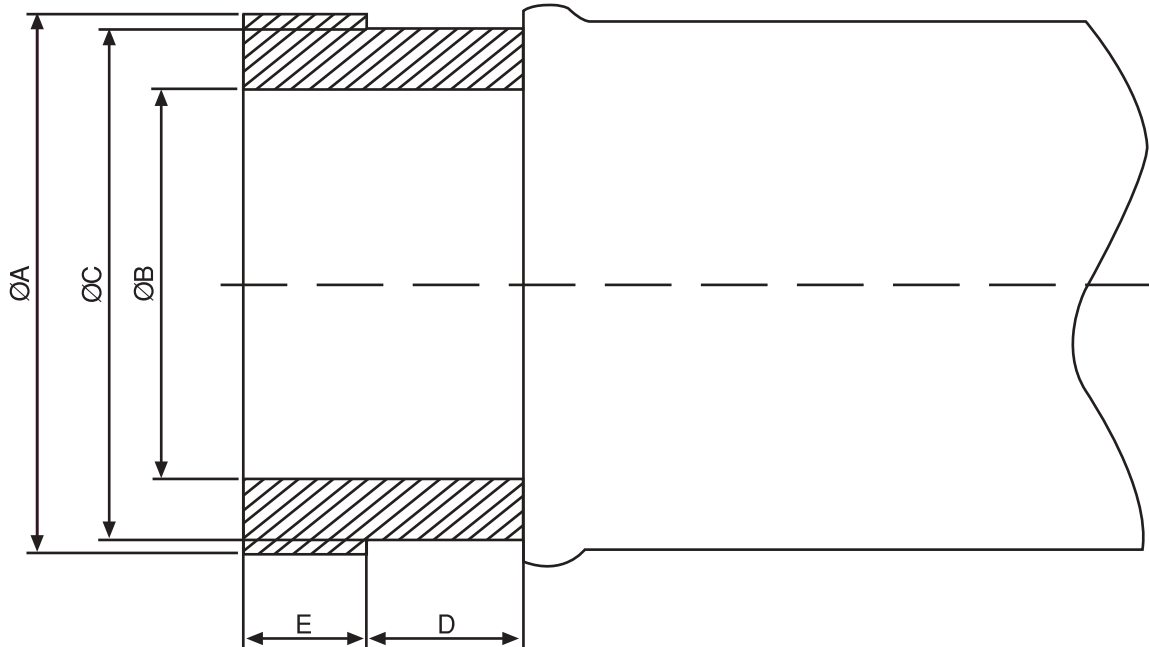

	2 1/2"	3"	4"	4 1/2"	5"	5 1/2"	6"
Ø A	89.0 mm	90.0 mm	114.3 mm	127.5 mm	142 mm	148 mm	175 mm
Ø B	64.4 mm	77.0 mm	98 mm	98.0 mm	124 mm	124 mm	147 mm
Ø C	84.6 mm	84.5 mm	108 mm	114.6 mm	133 mm	139 mm	162 mm
D	20.0 mm	18.0 mm	18 mm	18.0 mm	18 mm	18 mm	18 mm
E	16.0 mm	16.5 mm	17 mm	17.0 mm	17 mm	17 mm	17 mm

The inner part is hardened to min. 700 Hv. * 0.4 mm. DEPTH.
 Die tiefe der Innenteil ist 0.4 mm und hat min 700 Hv. HÄRTE
 Parte interiore indurito al min. 700 vickers * 0.4 mm di PROFONDITA
 La partie interieure est endurcie a min. 700 Hv. * 0.4 mm de PROFONDEUR

Material / Material / Materiale / Materiel:
 ST 52.0 DIN-1629 / ST 52.3-Din 17121/ ST 52.4-DIN 1630
 ASTM A 106 grade a or grade B api 5L Grade A or B

OPTIONS / OPTIONEN / OPZIONI / OPTIONS

- Upon Request : Heavy Duty Type.
- Auf Anfrage : Hochleistungsschlauch
- Su Richiesta : Per le applicazioni severe
- Sur Demande : Pour applications sévères

Heavy Duty Antiabrasive Suct. & Delivery



PU LINING



CONSTRUCTION : STRONG, FLEXIBLE PLASTICIZED PVC WITH ANTIABRASIVE POLYURETHANE INSIDE LAYER. SHOCK RESISTANT PVC SPIRAL.
APPLICATION : CRUSHING, CHEMICAL AGENTS, ABRASION AND WEATHER RESISTANT, LIGHT CORRUGATED OUTSIDE. FOR HEAVY-DUTY SUCTION AND DELIVERY OF WATER, SLURRIES, DUST AND GRAVEL ETC. IN INDUSTRIAL AND CONSTRUCTIONS. EXCELLENT RESISTANCE IN ABRASIVE APPLICATIONS.



KONSTRUKTION : HOCH ABRIEFESTE, FLEXIBLE, MIT POLYURETHAN VERSTÄRKT PVC SEELE. MIT VERSTÄRKUNGSSPIRALE AUS SCHLAG-UND DRUCKFESTEM PVC. ÄUSSERST STRAPAZIERFÄHIG UND BIEGSAM, DRUCK-UND ABRIEFEST, WITTERUNGSBESTÄNDIG, LEICHT GEWELLTE AUSSENDECKE.
ANWENDUNG : FÜR INDUSTRIELLE BEWÄSSERUNG, PRIVATE ANWENDUNGEN, BEFÖRDERUNG ABRASSIVER MEDIEN SOWIE WASSER/ABWASSER, GEEIGNET ALS HOCH ABRIEFESTER SAUG- UND DRUCKSCHLAUCH FÜR SCHWERE ANWENDUNGEN.



COSTRUZIONE : TUBO LISCIO, LEGGERO E FLESSIBILE IN PVC PLASTIFICATO COPERTO CON STRATO DI POLYURETANO ANTIABRASIVO SPIRALE DI RINFORZO IN PVC RIGIDO ANTI URTO E ANTISCHIACCIAMENTO.
IMPIEGO : ESTERNA SEMILISCIA, RESISTENTE A CARICHI, ABRASIONE E AGENTI ATMOSFERICI ED A VARI PRODOTTI CHIMICI. PER ELEVATE ASPIRAZIONE E MANDATA DI ACQUE, LIQUIDI E SOLIDI ABRASSIVI, PER USO IN, EDILIZIA, INDUSTRIA SPURGHI, RESISTENZA ECCELLENTE NEGLI APPLICAZIONI ABRASSIVI.



CONSTRUCTION : TUYAU LISSE ET FLEXIBLE EN PVC SOUPLE COUVERT D'UNE COUCHE PU ANTIABRASIVE. SPIRE EN PVC RIGIDE ANTICHOC.
APPLICATION : SURFACE SEMI-ONDULEE RESISTANTE A L'ABRASION, LES AGENTS ATMOSPHERIQUES, ECRASEMENT ET LA PLUPART DES PRODUITS CHIMIQUES. ASPIRATION ET REFOULEMENT D'EAU PURE, SALEE, CHARGEE DES SOLUTIONS, SABLE, GRAVIER, DES EAUX CHARGEES ETC. EN USAGES SEVERES DANS L'INDUSTRIE ET CONSTRUCTION. RESISTANCE EXCEPTIONNELLE A L'ABRASION.

ID		BP		VACUUM	BR/r	W	L
inch	mm	bar	psi	m/H ₂ O	mm	g/m	m
	40	30	435	9	275	810	30/50
	45	25	363	9	300	960	30/50
2"	51	25	363	9	330	1150	30/50
	60	25	363	9	400	1550	30/50
3"	76	20	290	9	495	1950	30/50
	80	20	290	9	540	2100	20/30
4"	102	15	218	9	700	3250	20/30
	120	15	218	8	880	3800	20/30
5"	127	15	218	8	970	4150	20/30
6"	152	12	174	7	1210	6200	20/30

OPTIONS / OPTIONEN / OPZIONI / OPTIONS

Upon Request : With antistatic copper wire
 Auf Anfrage : Mit antistatischen Kupferdraht
 Su Richiesta : Con cordicella di rame
 Sur Demande : Avec fil de masse antistatique



- 5 °C / + 60°C
 +23 °F / +140 °F

MARKING / BESCHRIFTUNG / MARCATURA / MARQUAGE: **INK-JET**

SEL LYMRA HD-PU ** mm (month/year) → → →

NORMS NORMEN NORME NORMES	ISO 1307	COLOUR FARBEN COLORI COULEUR	
------------------------------------	----------	---------------------------------------	--

Abrasion-Paratub



CONSTRUCTION : ABRASION RESISTANT BEIGE NATURAL RUBBER.
APPLICATION : DISCHARGE OF ABRASIVE MATERIALS, SUCH AS SAND, GRAVEL, CEMENT, GRAIN AND POWDER WITHOUT PRESSURE.







KONSTRUKTION : HOCH ABRIEFEST, NATURGUMMI, BEIGE
ANWENDUNG : ZUR DRUCKLOSEN BEFÖRDERUNG VON ABRASIVEN MEDIEN WIE SAND, KIES, TROCKENEM ZEMENT USW.



COSTRUZIONE : GOMMA NATURALE BEIGE, RESISTENTE ALL'ABRASIONE.
IMPIEGO : SCARICO SENZA PRESSIONE DI MATERIALI ABRASIVI: SABBIA, GHIAIA, CEMENTO, GRANAGLIE E PULVERULENTI.



CONSTRUCTION : CAOUTCHOUC NATUREL BEIGE RESISTANT A L'ABRASION.
APPLICATION : REFOULEMENT SANS PRESSION DES MATIERES ABRASIVES, COMME LE SABLE, GRAVIER, CIMENT, CÉRÉALES ET POUDRES.

 ID		 OD		 W	 L
inch	mm	mm	g/m	m	
1"	25.4	35.4	475	40-46-61	
1 3/8"	35	45	625	40-46-61	
1 3/4"	45	55	810	40-46-61	
2"	50.8	60	797	40-46-61	
3"	76.2	86.2	1269	40-46-61	
3 1/2"	90	100	1485	40-46-61	
4"	101.6	111.6	1665	40-46-61	
4 1/2"	114	124	1867	20-40-46	
5"	127	137	2062	20	
5 1/2"	140	150	2265	20	
6"	152.4	162.4	2460	20	
6 5/8"	168	178	2705	20	
8"	203	213	3250	20	
8 5/8"	219	229	3500	10	
10"	254	264	4046	10	
10 3/4"	273	283	4343	10	
12"	306	316	4855	10	
12 3/4"	323	333	5129	10	
14"	356	366	5637	6	
16"	406	416	6430	6	
17 3/4"	450	460	7110	2	
18"	457	467	7218	6	
20"	508	518	8015	6	



-40°C / + 70°C
-40°F / +158°F

NORMS
NORMEN
NORME
NORMES

ISO 1307

COLOUR
FARBEN
COLORI
COULEUR



Abrasion-Pararub



TUBE : ABRASION RESISTANT NATURAL RUBBER. (BEIGE COLOUR).
 REINFORCEMENT : HIGH TENSILE SYNTHETIC TEXTILE AND ANTISTATIC COPPER WIRE.
 COVER : ABRASION, OZONE AND WEATHER RESISTANT PIN-PRICKED SPECIAL SYNTHETIC RUBBER.
 APPLICATION : FOR DISCHARGE OF ABRASIVE POWDERS, DUST, GRANULES, SAND, GRAVEL, CEMENT AND POWDER ETC.



SEELE : HOCH ABRIEBFEST, NATURGUMMI, BEIGE.
 EINLAGE : HOCHZUGFESTE SYNTHETISCHE TEXTILEINLAGE UND ANTISTATISCHER KUPFERLITZE.
 DECKE : OZON- UND WITTERUNGSBESTÄNDIGER, ABRIEBSFESTER, SPEZIELLER SYNTHETISCHER GUMMI, GEPRICKT.
 ANWENDUNG : ZUR BEFÖRDERUNG VON ZEMENT UND ABRASIVEN PULVERN, GRANULATE, SAND UND KIES.



SOTTOSTRATO : GOMMA NATURALE RESISTENTE ALL'ABRASIONE. (COLORE BEIGE).
 RINFORZO : INSERZIONI TESSILI AD ALTA TENACITÀ CON CORDICELLA DI RAME ANTISTATICA.
 COPERTURA : GOMMA SPECIALE SINTETICA MICRO-FORATA, RESISTENTE ALL'ABRASIONE, ALL'OZONO ED AGLI AGENTI ATMOSFERICI.
 IMPIEGO : PER MANDATA DI POLVERI ABRASIVE, POLVERI, GRANULI, SABBIA, GHIAIA E CEMENTO ETC.



TUBE : CAOUTCHOUC NATUREL RESISTANT A L'ABRASION. (COULEUR BEIGE).
 RENFORCEMENT : INSERTION TEXTILE HAUTE TENACITE ET FIL DE MASSE ANTISTATIQUE.
 REVETEMENT : CAOUTCHOUC SYNTHETIQUE, MICRO-PERFORE, RESISTANT A L'ABRASION, A L'OZONE ET AUX AGENTS ATMOSPHERIQUES.
 APPLICATION : POUR REFOULEMENT DES POUDRES ABRASIVES, POUSSIERES, GRANULES, SABLE, GRAVIER, CIMENT, CÉRÉALES ET POUDRES. ETC.

ID		OD	WP		BP		W	L
inch	mm	mm	bar	psi	bar	psi	g/m	m
1"	25.4	37	10	145	30	435	595	40-46-61
1 1/4"	32	44	10	145	30	435	780	40-46-61
1 1/2"	38	50	10	145	30	435	900	40-46-61
2"	50.8	64.5	10	145	30	435	1350	40-46-61
2 1/2"	63.5	77	10	145	30	435	1650	40-46-61
3"	76.2	90	10	145	30	435	1980	40-46-61
3 1/2"	90	104	10	145	30	435	2430	40-46-61
4"	101.6	118	10	145	30	435	3145	40-46-61
5"	127	146	10	145	30	435	4610	40-46-61
6"	152.4	172	10	145	30	435	5725	40-46-61
8"	203.2	225	10	145	30	435	8345	20-40-46
10"	254	276	10	145	30	435	10935	25



-40°C / + 70°C
 -40°F / +158°F

MARKING / BESCHRIFTUNG / MARCATURA / MARQUAGE: **TRANSFER TAPE OR EMBOSSED**



NORMS NORMEN NORME NORMES	ISO 1307	COLOUR FARBEN COLORI COULEUR	
------------------------------------	----------	---------------------------------------	--



Abrasion S&D Pararub



TUBE : ABRASION RESISTANT NATURAL RUBBER. (BEIGE COLOUR).
 REINFORCEMENT : HIGH TENSILE SYNTHETIC TEXTILE, STEEL WIRE HELIX AND ANTISTATIC COPPER WIRE.
 COVER : OZON- UND WITTERUNGSBESTÄNDIGER, ABRIEBSFESTER, SPEZIELLER SYNTHETISCHER GUMMI, GEPRICKT.
 APPLICATION : FOR SUCTION AND DISCHARGE OF ABRASIVE POWDERS, DUST, GRANULES, SAND, GRAVEL, CEMENT AND POWDER ETC.



SEELE : HOCH ABRIEBSFEST, NATURGUMMI, BEIGE.
 EINLAGE : HOCHZUGFESTE SYNTHETISCHE TEXTILEINLAGE MIT EINER STAHLDRAHTSPIRALE UND ANTISTATISCHER KUPFERLITZE.
 DECKE : OZON- UND WITTERUNGSBESTÄNDIGER, ABRIEBSFESTER, SPEZIELLER SYNTHETISCHER GUMMI, GEPRICKT.
 ANWENDUNG : SAUG- DRUCKSCHLAUCH FÜR ZEMENT UND ABRASIVEN PULVERN, GRANULATE, SAND UND KIES.



SOTTOSTRATO : GOMMA NATURALE RESISTENTE ALL'ABRASIONE. (COLORE BEIGE).
 RINFORZO : INSERZIONI TESSILI AD ALTA TENACITÀ CON SPIRALE D'ACCIAIO E CORDICELLA DI RAME ANTISTATICA .
 COPERTURA : GOMMA SPECIALE SINTETICA MICRO-FORATA, RESISTENTE ALL'ABRASIONE, ALL'OZONO ED AGLI AGENTI ATMOSFERICI.
 IMPIEGO : PER ASPIRAZIONE E MANDATA DI POLVERI ABRASIVE, POLVERI, GRANULI, SABBIA, GHIAIA E CEMENTO ETC.



TUBE : CAOUTCHOUC NATUREL RESISTANT A L'ABRASION. (COULEUR BEIGE).
 RENFORCEMENT : INSERTION TEXTILE HAUTE TENACITE, SPIRALE EN ACIER ET FIL DE MASSE ANTISTATIQUE.
 REVETEMENT : CAOUTCHOUC SYNTHETIQUE, MICRO-PERFORE, RESISTANT A L'ABRASION, A L'OZONE ET AUX AGENTS ATMOSPHERIQUES.
 APPLICATION : POUR ASPIRATION ET REFOULEMENT DES POUDRES ABRASIVES, POUSSIERES, GRANULES, SABLE, GRAVIER, CIMENT, CÉRÉALES ET POUDRES. ETC.

ID		OD		WP		BP		VACUUM	BR/r	W	L
inch	mm	mm	bar	psi	bar	psi	bar	mm	g/m	m	
1"	25.4	39	10	145	30	435	-0.92	100	850	40-46-61	
1 1/4"	32	45	10	145	30	435	-0.92	125	1010	40-46-61	
1 1/2"	38	52	10	145	30	435	-0.92	150	1355	40-46-61	
2"	50.8	66	10	145	30	435	-0.92	200	1920	40-46-61	
2 1/2"	63.5	78.5	10	145	30	435	-0.92	250	2335	40-46-61	
3"	76.2	92	10	145	30	435	-0.92	300	3035	40-46-61	
3 1/2"	90	107	10	145	30	435	-0.92	360	3625	40-46-61	
4"	101.6	120	10	145	30	435	-0.92	450	4470	40-46-61	
5"	127	149	10	145	30	435	-0.80	570	6585	40-46-61	
6"	152.4	174.5	10	145	30	435	-0.80	700	8590	40-46-61	
8"	203.2	229	10	145	30	435	-0.80	990	13385	30	
10"	254	281	10	145	30	435	-0.80	1400	16790	20	



-40°C / + 70°C
 -40°F / +158°F

MARKING / BESCHRIFTUNG / MARCATURA / MARQUAGE: **TRANSFER TAPE OR EMBOSSED**



NORMS NORMEN NORME NORMES	ISO 1307	COLOUR FARBEN COLORI COULEUR	
------------------------------------	----------	---------------------------------------	--

Abrasion S&D Pararub

CORRUGATED



TUBE : ABRASION RESISTANT NATURAL RUBBER. (BEIGE COLOUR).
 REINFORCEMENT : HIGH TENSILE SYNTHETIC TEXTILE, STEEL WIRE HELIX AND ANTISTATIC COPPER WIRE.
 COVER : ABRASION, OZONE AND WEATHER RESISTANT CORRUGATED SPECIAL SYNTHETIC RUBBER.
 APPLICATION : FOR SUCTION AND DISCHARGE OF ABRASIVE POWDERS, DUST, GRANULES, SAND, GRAVEL, CEMENT AND POWDER ETC.



SEELE : HOCH ABRIEBFEST, NATURGUMMI, BEIGE.
 EINLAGE : HOCHZUGFESTE SYNTHETISCHE TEXTILEINLAGE MIT EINER STAHLDRAHTSPIRALE UND ANTISTATISCHER KUPFERLITZE.
 DECKE : OZON- UND WITTERUNGSBESTÄNDIGER, ABRIEBFESTER, SPEZIELLER SYNTHETISCHER GUMMI, GEWELLT.
 ANWENDUNG : SAUG- DRUCKSCHLAUCH FÜR ZEMENT UND ABRASIVEN PULVERN, GRANULATE, SAND UND KIES



SOTTOSTRATO : GOMMA NATURALE RESISTENTE ALL'ABRASIONE. (COLORE BEIGE).
 RINFORZO : INSERZIONI TESSILI AD ALTA TENACITÀ CON SPIRALE D'ACCIAIO E CORDICELLA DI RAME ANTISTATICA.
 COPERTURA : GOMMA SPECIALE SINTETICA ONDULATA, RESISTENTE ALL'ABRASIONE, ALL'OZONO ED AGLI AGENTI ATMOSFERICI.
 IMPIEGO : PER ASPIRAZIONE E MANDATA DI POLVERI ABRASIVE, POLVERI, GRANULI, SABBIA, GHIAIA E CEMENTO ETC.



TUBE : CAOUTCHOUC NATUREL RESISTANT A L'ABRASION. (COULEUR BEIGE).
 RENFORCEMENT : INSERTION TEXTILE HAUTE TENACITE, SPIRALE EN ACIER ET FIL DE MASSE ANTISTATIQUE.
 REVETEMENT : CAOUTCHOUC SYNTHETIQUE ONDULE, RESISTANT A L'ABRASION, A L'OZONO ET AUX AGENTS ATMOSPHERIQUES.
 APPLICATION : POUR ASPIRATION ET REFOULEMENT DES POUDRES ABRASIVES, POUSSIERES, GRANULES, SABLE, GRAVIER, CIMENT, CÉRÉALES ET POUDRES. ETC.

ID		OD		WP		BP		VACUUM	BR/r	W	L
inch	mm	mm	bar	psi	bar	psi	bar	mm	g/m	m	
1"	25.4	37.5	10	145	30	435	-0.92	75	803	40-46-61	
1 1/4"	32	44	10	145	30	435	-0.92	95	917	40-46-61	
1 1/2"	38	51	10	145	30	435	-0.92	110	1230	40-46-61	
2"	50.8	64.5	10	145	30	435	-0.92	150	1695	40-46-61	
2 1/2"	63.5	77.5	10	145	30	435	-0.92	190	2280	40-46-61	
3"	76.2	90.5	10	145	30	435	-0.92	225	2960	40-46-61	
3 1/2"	90	106	10	145	30	435	-0.92	270	3715	40-46-61	
4"	101.6	119	10	145	30	435	-0.92	325	4498	40-46-61	
5"	127	147	10	145	30	435	-0.80	450	6564	40-46-61	
6"	152.4	173	10	145	30	435	-0.80	550	8640	40-46-61	
8"	203.2	227	10	145	30	435	-0.80	900	13670	30	
10"	254	279	10	145	30	435	-0.80	1200	16785	20	



-40°C / + 70°C
 -40°F / +158°F

MARKING / BESCHRIFTUNG / MARCATURA / MARQUAGE: **TRANSFER TAPE OR EMBOSSED**



NORMS NORMEN NORME NORMES	ISO 1307	COLOUR FARBEN COLORI COULEUR	
------------------------------------	----------	---------------------------------------	--



Abrasion S&D Pararub

CHANNELED



TUBE : ABRASION RESISTANT NATURAL RUBBER. (BEIGE COLOUR).
 REINFORCEMENT : HIGH TENSILE SYNTHETIC TEXTILE, STEEL WIRE HELIX AND ANTISTATIC COPPER WIRE.
 COVER : ABRASION, OZONE AND WEATHER RESISTANT CHANNELED SPECIAL SYNTHETIC RUBBER.
 APPLICATION : FOR SUCTION AND DISCHARGE OF ABRASIVE POWDERS, DUST, GRANULES, SAND, GRAVEL, CEMENT AND POWDER ETC.



SEELE : HOCH ABRIEBFEST, NATURGUMMI, BEIGE.
 EINLAGE : HOCHZUGFESTE SYNTHETISCHE TEXTILEINLAGE MIT EINER STAHLDRAHTSPIRALE UND ANTISTATISCHER KUPFERLITZE.
 DECKE : OZON- UND WITTERUNGSBESTÄNDIGER, ABRIEBSFESTER, SPEZIELLER SYNTHETISCHER GUMMI, KORDELGERIPPT.
 ANWENDUNG : SAUG - DRUCKSCHLAUCH FÜR ZEMENT UND ABRASIVEN PULVERN, GRANULATE, SAND UND KIES.



SOTTOSTRATO : GOMMA NATURALE RESISTENTE ALL'ABRASIONE. (COLORE BEIGE).
 RINFORZO : INSERZIONI TESSILI AD ALTA TENACITÀ, CON SPIRALE D'ACCIAIO E CORDICELLA DI RAME ANTISTATICA.
 COPERTURA : GOMMA SPECIALE SINTETICA GRECATA, RESISTENTE ALL'ABRASIONE, ALL'OZONO ED AGLI AGENTI ATMOSFERICI.
 IMPIEGO : PER ASPIRAZIONE E MANDATA DI POLVERI ABRASIVE POLVERI, GRANULI, SABBIA, GHIAIA E CEMENTO ETC.



TUBE : CAOUTCHOUC NATUREL RESISTANT A L'ABRASION. (COULEUR BEIGE).
 RENFORCEMENT : INSERTION TEXTILE HAUTE TENACITE, SPIRALE EN ACIER ET FIL DE MASSE ANTISTATIQUE.
 REVETEMENT : CAOUTCHOUC SYNTHETIQUE ASPECT CRENELE, RESISTANT A L'ABRASION, A L'OZONO ET AUX AGENTS ATMOSPHERIQUES.
 APPLICATION : POUR ASPIRATION ET REFOULEMENT DES POUDRES ABRASIVES, POUSSIERES, GRANULES, SABLE, GRAVIER, CIMENT, CÉRÉALES ET POUDRES. ETC.

ID		OD		WP		BP		VACUUM	BR/r	W	L
inch	mm	mm	mm	bar	psi	bar	psi	bar	mm	g/m	m
1"	25.4	36	10	145	30	435	-0.92	50	760	40-46-61	
1 1/4"	32	42.5	10	145	30	435	-0.92	65	920	40-46-61	
1 1/2"	38	48.4	10	145	30	435	-0.92	80	1065	40-46-61	
2"	50.8	62	10	145	30	435	-0.92	115	1575	40-46-61	
2 1/2"	63.5	76	10	145	30	435	-0.92	160	2070	40-46-61	
3"	76.2	89	10	145	30	435	-0.92	190	2370	40-46-61	
3 1/2"	90	104.5	10	145	30	435	-0.92	235	3340	40-46-61	
4"	101.6	117.5	10	145	30	435	-0.92	265	4035	40-46-61	
5"	127	145.5	10	145	30	435	-0.80	355	6115	40-46-61	
6"	152.4	172	10	145	30	435	-0.80	550	7810	40-46-61	



-40°C / + 70°C
 -40°F / +158°F

MARKING / BESCHRIFTUNG / MARCATURA / MARQUAGE: **TRANSFER TAPE OR EMBOSSED**

SEL PARARUB-GR ABRASION - S/D PARARUB HOSE W.P. 10 Bar (145 PSI)

NORMS NORMEN NORME NORMES	ISO 1307	COLOUR FARBEN COLORI COULEUR	
------------------------------------	----------	---------------------------------------	--

Material Handling Rubber Beaded End with Flange



 TUBE : ABRASION RESISTANT ANTISTATIC NATURAL RUBBER.
 REINFORCEMENT : HIGH TENSILE SYNTHETIC TEXTILE, STEEL WIRE HELIX AND ANTISTATIC COPPER WIRE.
 COVER : ABRASION, OZONE AND WEATHER RESISTANT SPECIAL SYNTHETIC RUBBER.
 APPLICATION : FOR SUCTION AND DISCHARGE OF ABRASIVE MATERIALS.

 SEELE : HOCH ABRIEBFEST, NATURGUMMI, LEITFÄHIG.
 EINLAGE : HOCHZUGFESTE SYNTHETISCHE TEXTILEINLAGE MIT EINER STAHLDRAHTSPIRALE UND ANTISTATISCHER KUPFERLITZE.
 DECKE : OZON- UND WITTERUNGSBESTÄNDIGER, ABRIEBFESTER, SPEZIELLER SYNTHETISCHER GUMMI.
 ANWENDUNG : SAUG - DRUCKSCHLAUCH FÜR ABRASIVE MATERIALIEN.

 SOTTOSTRATO : GOMMA NATURALE ANTISTATICA, RESISTENTE ALL'ABRASIONE.
 RINFORZO : INSERZIONI TESSILI AD ALTA TENACITÀ CON SPIRALE D'ACCIAIO E CORDICELLA DI RAME ANTISTATICA.
 COPERTURA : GOMMA SPECIALE SINTETICA, RESISTENTE ALL'ABRASIONE, ALL'OZONO ED AGLI AGENTI ATMOSFERICI.
 IMPIEGO : PER ASPIRAZIONE E MANDATA DI PRODOTTI ABRASIVI.

 TUBE : CAOUTCHOUC NATUREL CONDUCTEUR, RESISTANT A L'ABRASION.
 RENFORCEMENT : INSERTION TEXTILE HAUTE TENACITE, SPIRALE EN ACIER ET FIL DE MASSE ANTISTATIQUE.
 REVETEMENT : CAOUTCHOUC SYNTHETIQUE, RESISTANT A L'ABRASION, A L'OZONE ET AUX AGENTS ATMOSPHERIQUES.
 APPLICATION : POUR ASPIRATION ET REFOULEMENT DES MATIERES ABRASIVES.

ID		OD		WP		BP		VACUUM	BR/r	W	L
inch	mm	mm	mm	bar	psi	bar	psi	bar	mm	g/m	m
3"	76.2	103	103	10	145	30	435	-0.92	305	5175	1 - 61
4"	101.6	131	131	10	145	30	435	-0.92	550	7230	1 - 61
5"	127	156	156	10	145	30	435	-0.80	650	9180	1 - 61
6"	152.4	180	180	10	145	30	435	-0.80	900	10550	1 - 61
8"	203	233	233	10	145	30	435	-0.80	1200	15520	1 - 20
10"	254	291	291	8	116	24	348	-0.80	1600	23500	1 - 10
12"	298	333	333	8	116	24	348	-0.80	2050	27100	1 - 10

Abrasion loss value: Acc DIN 53516 ≤ 60 mm³
 Abriebwert nach DIN 53516 ≤ 60 mm³
 Perdita d'abrasione in accordo alla norma DIN 53516 ≤ 60 mm³
 Indice d'abrasion: Selon la norme DIN 53516 ≤ 60 mm³

NOTES ON ORDERING
 A - Inside diameter
 B - Length (Overall Length)
 C - Working pressure
 D - Type ends or end fittings
 E - Applications (Much detail as possible)
 F - Working temperature

BEMERKUNGEN ZUM AUFTRAG
 A - Innendurchmesser
 B - Schlauchlänge F-F
 C - Betriebsdruck
 D - Flanschbezeichnung
 E - Einsatzbedingungen (Möglichst viele Information angeben)
 F - Betriebstemperatur

NOTE ORDINI
 A - Diametro interno
 B - Lunghezza (Flange Incluso)
 C - Pressione di lavoro
 D - Specificazioni per le flange
 E - Applicazione (Massimo dettagli possibile)
 F - Temperatura di lavoro

PRECISIONS NECESSAIRES
 A - Diametre interieur
 B - Longueur (Brides incluses)
 C - Pression de service
 D - Specificaions des brides
 E - Applications (Plus de details possible)
 F - Temperature de travail



MARKING / BESCHRIFTUNG / MARCATURA / MARQUAGE: **TRANSFER TAPE OR EMBOSSED**



NORMS NORMEN NORME NORMES	ISO 1307	COLOUR FARBEN COLORI COULEUR	
------------------------------------	----------	---------------------------------------	--

Food

Lebensmittel Schläuche

Prodotti Alimentari

Produits Alimentaires

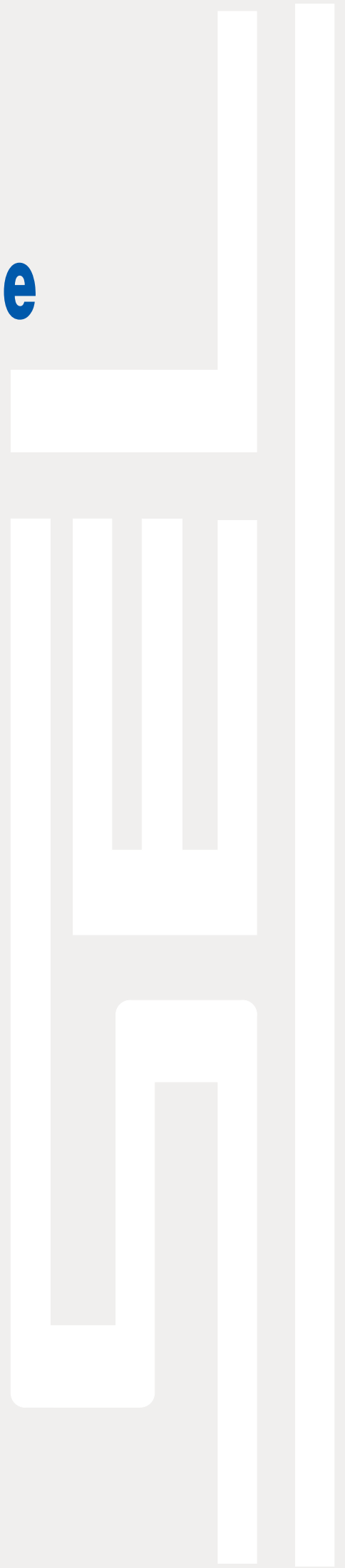

Potable Water Delivery

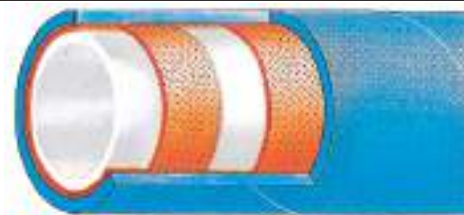

TUBE : WHITE NON-TOXIC, FOOD QUALITY, TASTE AND ODOUR FREE, SPECIAL SYNTHETIC RUBBER.
 REINFORCEMENT : HIGH TENSILE SYNTHETIC TEXTILE.
 COVER : WEATHER, OZONE AND ABRASION RESISTANT, SPECIAL SYNTHETIC RUBBER.
 APPLICATION : FOR DISCHARGE OF POTABLE WATER.



SEELE : GESCHMACKS- UND GERUCHSNEUTRAL, LEBENSMITTELECHT, SPEZIELLER SYNTHETISCHER GUMMI, WEISS, SCHADSTOFFFREI.
 EINLAGE : HOCHZUGFESTE SYNTHETISCHE TEXTILEINLAGE.
 DECKE : OZON-UND WITTERUNGSBESTÄNDIGER, ABRIEBSFESTER, SPEZIELLER SYNTHETISCHER GUMMI.
 ANWENDUNG : ZUM DURCHLEITEN VON TRINKWASSER.



SOTTOSTRATO : GOMMA SPECIALE SINTETICA BIANCA ATOSSICA, DI QUALITÀ ALIMENTARE INSAPORE ED INODORE.
 RINFORZO : INSERZIONI TESSILI AD ALTA TENACITÀ.
 COPERTURA : GOMMA SPECIALE SINTETICA, RESISTENTE ALL'ABRASIONE, ALL'OZONO ED AGLI AGENTI ATMOSFERICI.
 IMPIEGO : PER MANDATA DI ACQUA POTABILE.



TUBE : CAOUTCHOUC SYNTHETIQUE SPECIAL BLANC, NON TOXIQUE, QUALITE ALIMENTAIRE, ANTI ODEUR ET NE TRANSMETTANT PAS DE GOUT.
 RENFORCEMENT : INSERTION TEXTILE HAUTE TENACITE.
 REVETEMENT : CAOUTCHOUC SYNTHETIQUE SPECIAL, RESISTANT A L'ABRASION, A L'OZONE ET AUX AGENTS ATMOSPHERIQUES.
 APPLICATION : POUR REFOULEMENT D'EAU POTABLE.

ID		OD		WP		BP		W	L
inch	mm	mm	mm	bar	psi	bar	psi	g/m	m
3/4"	19	30	10	145	30	435	634	40-46-61	
1"	25.4	37	10	145	30	435	820	40-46-61	
1 1/4"	32	44	10	145	30	435	1080	40-46-61	
1 1/2"	38	51	10	145	30	435	1365	40-46-61	
1 3/4"	44.5	57.5	10	145	30	435	1565	40-46-61	
2"	50.8	65	10	145	30	435	1910	40-46-61	
2 1/2"	63.5	77.5	10	145	30	435	2330	40-46-61	
3"	76.2	92	10	145	30	435	3030	40-46-61	
4"	101.6	117.5	10	145	30	435	3955	40-46-61	



Sanification : Max. 120 °C for 15 min. with steam, max. 50 °C for 15 min. with caustic soda (5%).
 Sterilisierung : Bei max. 120 °C für 15 min. mit dampf, bei max. 50 °C für 15 min. mit natronlauge (5%).
 Sanificazione : Massimo 120 °C per 15 minuti con vapore, massimo 50 °C per 15 minuti con soda caustica (5%).
 Sanification : 120 °C max. pendant 15 min. avec vapeur à 50 °C max. pendant 15 min. avec soude caustique (5%).



-40°C / + 70°C
 -40°F / +158°F

MARKING / BESCHRIFTUNG / MARCATURA / MARQUAGE: **TRANSFER TAPE OR EMBOSSED**

SEL **SPRING D/10** **POTABLE WATER DELIVERY HOSE - W.P. 10 Bar (145 PSI)** → → →

NORMS NORMEN NORME NORMES	ISO 1307 MEETS FDA REQUIREMENTS	COLOUR FARBEN COLORI COULEUR	  
------------------------------------	------------------------------------	---------------------------------------	--

Potable Water S&D



TUBE : WHITE, NON-TOXIC, FOOD QUALITY, TASTE AND ODOUR FREE, SPECIAL SYNTHETIC RUBBER.
 REINFORCEMENT : HIGH TENSILE SYNTHETIC TEXTILE AND STEEL WIRE HELIX.
 COVER : WEATHER, OZONE AND ABRASION RESISTANT, SPECIAL SYNTHETIC RUBBER.
 APPLICATION : FOR SUCTION AND DISCHARGE OF POTABLE WATER.



SEELE : GESCHMACKS- UND GERUCHSNEUTRAL, LEBENSMITTELECHT, SPEZIELLER SYNTHETISCHER GUMMI, WEISS, SCHADSTOFFFREI.
 EINLAGE : HOCHZUGFESTE SYNTHETISCHE TEXTILEINLAGE MIT EINER STAHLDRAHTSPIRALE.
 DECKE : OZON-UND WITTERUNGSBESTÄNDIGER, ABRIEBSFESTER, SPEZIELLER SYNTHETISCHER GUMMI.
 ANWENDUNG : FÜR TRINKWASSER GEEIGNETER SAUG- UND DRUCKSCHLAUCH.



SOTTOSTRATO : GOMMA SPECIALE SINTETICA BIANCA ATOSSICA, DI QUALITÀ ALIMENTARE INSAPORE ED INODORE.
 RINFORZO : INSERZIONI TESSILI AD ALTA TENACITÀ CON SPIRALE D'ACCIAIO.
 COPERTURA : GOMMA SPECIALE SINTETICA, RESISTENTE ALL'ABRASIONE, ALL'OZONO ED AGLI AGENTI ATMOSFERICI.
 IMPIEGO : PER ASPIRAZIONE E MANDATA DI ACQUA POTABILE.



TUBE : CAOUTCHOUC SYNTHETIQUE SPECIAL BLANC, NON TOXIQUE, QUALITE ALIMENTAIRE, ANTI ODEUR ET NE TRANSMETTANT PAS DE GOUT.
 RENFORCEMENT : INSERTION TEXTILE HAUTE TENACITE ET SPIRALE EN ACIER NOYEE..
 REVETEMENT : CAOUTCHOUC SYNTHETIQUE SPECIAL, RESISTANT A L'ABRASION, A L'OZONE ET AUX AGENTS ATMOSPHERIQUES.
 APPLICATION : POUR ASPIRATION ET REFOULEMENT D'EAU POTABLE.

ID		OD		WP		BP		VACUUM	BR/r	W	L
inch	mm	mm	mm	bar	psi	bar	psi	bar	mm	g/m	m
3/4"	19	31	10	145	30	435	-0.92	60	730	40-46-61	
1"	25.4	38	10	145	30	435	-0.92	80	984	40-46-61	
1 1/4"	32	45	10	145	30	435	-0.92	100	1260	40-46-61	
1 1/2"	38	52	10	145	30	435	-0.92	120	1690	40-46-61	
1 3/4"	44.5	58.5	10	145	30	435	-0.92	145	1870	40-46-61	
2"	50.8	66	10	145	30	435	-0.92	165	2335	40-46-61	
2 1/2"	63.5	78.5	10	145	30	435	-0.92	250	2860	40-46-61	
3"	76.2	93	10	145	30	435	-0.92	380	3805	40-46-61	
4"	101.6	118.5	10	145	30	435	-0.92	500	4835	40-46-61	

Sanification : Max. 120 °C for 15 min. with steam, max. 50 °C for 15 min. with caustic soda (5%).
 Sterilisierung : Bei max. 120 °C für 15 min. mit dampf, bei max. 50 °C für 15 min. mit natronlauge (5%).
 Sanificazione : Massimo 120 °C per 15 minuti con vapore, massimo 50 °C per 15 minuti con soda caustica (5%).
 Sanification : 120 °C max. pendant 15 min. avec vapeur à 50 °C max. pendant 15 min. avec soude caustique (5%).



-40 °C / + 70 °C
 -40 °F / +158 °F

MARKING / BESCHRIFTUNG / MARCATURA / MARQUAGE: **TRANSFER TAPE OR EMBOSSED**

SEL SPRING SD/10 POTABLE WATER S/D HOSE - W.P. 10 Bar (145 PSI)

NORMS NORMEN NORME NORMES	ISO 1307 MEETS FDA REQUIREMENTS	COLOUR FARBEN COLORI COULEUR	
------------------------------------	------------------------------------	---------------------------------------	--

Milk Delivery

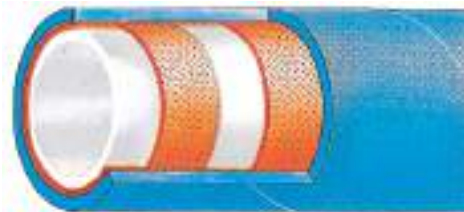

TUBE : WHITE, NON-TOXIC, TASTE AND ODOUR FREE, VEGETABLE OIL RESISTANT, FOOD GRADE NBR RUBBER.
 REINFORCEMENT : HIGH TENSILE SYNTHETIC TEXTILE .
 COVER : OIL, WEATHER, OZONE AND ABRASION RESISTANT, SPECIAL SYNTHETIC RUBBER.
 APPLICATION : DISCHARGE OF MILK FOR USE ON TANK TRUCK OR TANK VAGON.



SEELE : GESCHMACKS- UND GERUCHSNEUTRAL , LEBENSMITTELECHT , SPEZIELLER NBR GUMMI, WEISS, SCHADSTOFFFREI, BESTÄNDIG GEGEN PFLANZLICHE ÖLE.
 EINLAGE : HOCHZUGFESTE SYNTHETISCHE TEXTILEINLAGE.
 DECKE : ÖL-, OZON- UND WITTERUNGSBESTÄNDIGER, ABRIEBSFESTER, SPEZIELLER SYNTHETISCHER GUMMI.
 ANWENDUNG : DRUCKSCHLAUCH FÜR MILCHSAMMELWAGEN UND MILCHSILOS.



SOTTOSTRATO : GOMMA NBR BIANCA ATOSSICA, DI QUALITA'ALIMENTARE INSAPORE ED INODORE, ADATTA PER IL PASSAGGIO DI LATTE.
 RINFORZO : INSERZIONI TESSILI AD ALTA TENACITÀ.
 COPERTURA : GOMMA SPECIALE SINTETICA, RESISTANTE ALL'ABRASIONE, AGLI OLI, ALL'OZONO ED AGLI AGENTI ATMOSFERICI.
 IMPIEGO : PER MANDATA DI LATTE, IDONEO PER IL TRASPORTO SU VAGONI E CAMION CISTERNA ETC.



TUBE : CAOUTCHOUC NBR BLANC QUALITE ALIMENTAIRE, NON TOXIQUE, ANTI ODEUR ET NE TRANSMETTANT PAS DE GOUT, RESISTANT AUX HUILES VEGETALES .
 RENFORCEMENT : INSERTION TEXTILE HAUTE TENACITE .
 REVETEMENT : CAOUTCHOUC SYNTHETIQUE SPECIAL, RESISTANT A L'ABRASION, A L'OZONE, AUX HUILES ET AUX AGENTS ATMOSPHERIQUES.
 APPLICATION : POUR REFOULEMENT DE LAIT, SUR LES WAGONS ET LES CAMIONS CITERNES ETC.

ID		OD	WP		BP		W	L
inch	mm	mm	bar	psi	bar	psi	g/m	m
3/4"	19	28.5	6	87	18	261	505	40-46-61
1"	25.4	35	6	87	18	261	643	40-46-61
1 1/4"	32	43	6	87	18	261	960	40-46-61
1 1/2"	38	49	6	87	18	261	1125	40-46-61
1 3/4"	44.5	55.5	6	87	18	261	1295	40-46-61
2"	50.8	62	6	87	18	261	1490	40-46-61
2 1/2"	63.5	75	6	87	18	261	1795	40-46-61
3"	76.2	89	6	87	18	261	2320	40-46-61
4"	101.6	115	6	87	18	261	3175	40-46-61

Sanification : Max. 120 °C for 15 min. with steam, max. 50 °C for 15 min. with caustic soda (5%).
 Sterilisierung : Bei max. 120 °C für 15 min. mit dampf, bei max. 50 °C für 15 min. mit natronlauge (5%).
 Sanificazione : Massimo 120 °C per 15 minuti con vapore, massimo 50 °C per 15 minuti con soda caustica (5%).
 Sanification : 120 °C max. pendant 15 min. avec vapeur à 50 °C max. pendant 15 min. avec soude caustique (5%).



-40°C / + 80°C
 -40°F / +176°F

MARKING / BESCHRIFTUNG / MARCATURA / MARQUAGE: **TRANSFER TAPE OR EMBOSSED**



NORMS NORMEN NORME NORMES	ISO 1307 MEETS FDA REQUIREMENTS	COLOUR FARBEN COLORI COULEUR	
------------------------------------	------------------------------------	---------------------------------------	--



Milk Suction & Delivery



TUBE : WHITE, NON-TOXIC, TASTE AND ODOUR FREE, VEGETABLE OIL RESISTANT, FOOD GRADE NBR RUBBER.
 REINFORCEMENT : HIGH TENSILE SYNTHETIC TEXTILE AND STEEL WIRE HELIX.
 COVER : OIL, WEATHER, OZONE AND ABRASION RESISTANT, SPECIAL SYNTHETIC RUBBER.
 APPLICATION : SUCTION AND DISCHARGE OF MILK FOR USE ON TANK TRUCK OR TANK VAGON.



SEELE : GESCHMACKS- UND GERUCHSNEUTRAL, LEBENSMITTELECHT, SPEZIELLER NBR GUMMI, WEISS, SCHADSTOFFFREI, BESTÄNDIG GEGEN PFLANZLICHE ÖLE
 EINLAGE : HOCHZUGFESTE SYNTHETISCHE TEXTILEINLAGE.
 DECKE : ÖL-, OZON- UND WITTERUNGSBESTÄNDIGER, ABRIEBSFESTER, SPEZIELLER SYNTHETISCHER GUMMI.
 ANWENDUNG : DRUCKSCHLAUCH FÜR MILCH, PFLANZLICHE ÖLE UND GETRÄNKE



SOTTOSTRATO : GOMMA NBR BIANCA ATOSSICA, DI QUALITÀ ALIMENTARE INSAPORE ED INODORE, ADATTA PER IL PASSAGGIO DI LATTE, ED OLI VEGETALI.
 RINFORZO : INSERZIONI TESSILI AD ALTA TENACITÀ CON SPIRALE D'ACCIAIO.
 COPERTURA : GOMMA SPECIALE SINTETICA, RESISTENTE ALL'ABRASIONE, AGLI OLI, ALL'OZONO ED AGLI AGENTI ATMOSFERICI.
 IMPIEGO : ASPIRAZIONE E MANDATA DI LATTE, IDONEO PER IL TRASPORTO SU WAGONI E CAMION CISTERNA ETC.



TUBE : CAOUTCHOUC NBR BLANC QUALITE ALIMENTAIRE, NON TOXIQUE, ANTI ODEUR ET NE TRANSMETTANT PAS DE GOUT, RESISTANT AUX HUILES VEGETALES.
 RENFORCEMENT : INSERTION TEXTILE HAUTE TENACITE ET SPIRALE EN ACIER NOYEE.
 REVETEMENT : CAOUTCHOUC SYNTHETIQUE SPECIAL, RESISTANT A L'ABRASION, A L'OZONE, AUX HUILES ET AUX AGENTS ATMOSPHERIQUES.
 APPLICATION : POUR ASPIRATION ET REFOULEMENT DE LAIT, SUR LES WAGONS ET LES CAMIONS CITERNES ETC.

ID		OD		WP		BP		VACUUM	BR/r	W	L
inch	mm	mm	mm	bar	psi	bar	psi	bar	mm	g/m	m
3/4"	19	29		6	87	18	261	-0.92	60	620	40-46-61
1"	25.4	36		6	87	18	261	-0.92	85	805	40-46-61
1 1/4"	32	43		6	87	18	261	-0.92	105	1055	40-46-61
1 1/2"	38	49		6	87	18	261	-0.92	125	1361	40-46-61
1 3/4"	44.5	56		6	87	18	261	-0.92	150	1661	40-46-61
2"	50.8	62.5		6	87	18	261	-0.92	170	1870	40-46-61
2 1/2"	63.5	74.5		6	87	18	261	-0.92	200	2185	40-46-61
3"	76.2	89		6	87	18	261	-0.92	380	3080	40-46-61
4"	101.6	115		6	87	18	261	-0.92	500	4275	40-46-61

Sanification : Max. 120 °C for 15 min. with steam, max. 50 °C for 15 min. with caustic soda (5%).
 Sterilisierung : Bei max. 120 °C für 15 min. mit dampf, bei max. 50 °C für 15 min. mit natronlauge (5%).
 Sanificazione : Massimo 120 °C per 15 minuti con vapore, massimo 50 °C per 15 minuti con soda caustica (5%).
 Sanification : 120 °C max. pendant 15 min. avec vapeur à 50 °C max. pendant 15 min. avec soude caustique (5%).



-40 °C / + 80 °C
 -40 °F / +176 °F

MARKING / BESCHRIFTUNG / MARCATURA / MARQUAGE: **TRANSFER TAPE OR EMBOSSED**

SEL **MITANK SD/6** MILK & VEGETABLE OIL S/D HOSE - W.P. 6 Bar (87 PSI)

NORMS
 NORMEN
 NORME
 NORMES

ISO 1307
 MEETS FDA REQUIREMENTS

COLOUR
 FARBEN
 COLORI
 COULEUR



Milk & Vegetable Oil Delivery

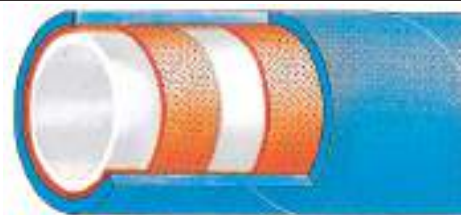

TUBE : WHITE, NON-TOXIC, TASTE AND ODOUR FREE, VEGETABLE OIL RESISTANT, FOOD GRADE NBR RUBBER.
 REINFORCEMENT : HIGH TENSILE SYNTHETIC TEXTILE.
 COVER : OIL, WEATHER, OZONE AND ABRASION RESISTANT, SPECIAL SYNTHETIC RUBBER.
 APPLICATION : FOR DISCHARGE OF MILK, VEGETABLE OIL AND BEVERAGES.



SEELE : GESCHMACKS- UND GERUCHSNEUTRAL, LEBENSMITTELECHT, SPEZIELLER SYNTHETISCHER NBR GUMMI, WEISS, SCHADSTOFFFREI, BESTÄNDIG GEGEN PFLANZLICHE ÖLE.
 EINLAGE : HOCHZUGFESTE SYNTHETISCHE TEXTILEINLAGE MIT EINER STAHLDRAHTSPIRALE.
 DECKE : ÖL-, OZON- UND WITTERUNGSBESTÄNDIGER, ABRIEBSFESTER, SPEZIELLER SYNTHETISCHER GUMMI.
 ANWENDUNG : SAUG-DRUCKSCHLAUCH FÜR MILCHSAMMELWAGEN UND MILCHSILOS.



SOTTOSTRATO : GOMMA NBR BIANCA ATOSSICA, DI QUALITÀ ALIMENTARE INSAPORE ED INODORE, ADATTA PER IL PASSAGGIO DI LATTE, ED OLI VEGETALI.
 RINFORZO : INSERZIONI TESSILI AD ALTA TENACITÀ.
 COPERTURA : GOMMA SPECIALE SINTETICA, RESISTENTE ALL'ABRASIONE, AGLI OLI, ALL'OZONO ED AGLI AGENTI ATMOSFERICI.
 IMPIEGO : PER MANDATA DI PRODOTTI ALIMENTARI, GRASSI, E LATTE.



TUBE : CAOUTCHOUC NBR BLANC QUALITÉ ALIMENTAIRE, NON TOXIQUE, ANTI ODEUR ET NE TRANSMETTANT PAS DE GOUT, RESISTANT AUX HUILES VEGETALES.
 RENFORCEMENT : INSERTION TEXTILE HAUTE TENACITE.
 REVETEMENT : CAOUTCHOUC SYNTHETIQUE SPECIAL, RESISTANT A L'ABRASION, A L'OZONE, AUX HUILES ET AUX AGENTS ATMOSPHERIQUES.
 APPLICATION : POUR LE REFOULEMENT DE LAIT, DES BOISSONS ET DES HUILES VEGETALES.

ID		OD	WP		BP		W	L
inch	mm	mm	bar	psi	bar	psi	g/m	m
3/4"	19	30	10	145	30	435	613	40-46-61
1"	25.4	37	10	145	30	435	793	40-46-61
1 1/4"	32	44	10	145	30	435	1048	40-46-61
1 1/2"	38	51	10	145	30	435	1314	40-46-61
1 3/4"	44.5	57.5	10	145	30	435	1507	40-46-61
2"	50.8	65	10	145	30	435	1835	40-46-61
2 1/2"	63.5	77.5	10	145	30	435	2269	40-46-61
3"	76.2	92	10	145	30	435	2928	40-46-61
4"	101.6	117.5	10	145	30	435	3825	40-46-61



Sanification : Max. 120 °C for 15 min. with steam, max. 50 °C for 15 min. with caustic soda (5%).
 Sterilisierung : Bei max. 120 °C für 15 min. mit dampf, bei max. 50 °C für 15 min. mit natronlauge (5%).
 Sanificazione : Massimo 120 °C per 15 minuti con vapore, massimo 50 °C per 15 minuti con soda caustica (5%).
 Sanification : 120 °C max. pendant 15 min. avec vapeur à 50 °C max. pendant 15 min. avec soude caustique (5%).



-40°C / + 80°C
 -40°F / +176°F

MARKING / BESCHRIFTUNG / MARCATURA / MARQUAGE: **TRANSFER TAPE OR EMBOSSED**



NORMS NORMEN NORME NORMES	ISO 1307 MEETS FDA REQUIREMENTS	COLOUR FARBEN COLORI COULEUR	  
------------------------------------	------------------------------------	---------------------------------------	--

Milk & Vegetable Oil S&D



TUBE : WHITE, NON-TOXIC, TASTE AND ODOUR FREE, VEGETABLE OIL RESISTANT, FOOD GRADE NBR RUBBER.
 REINFORCEMENT : HIGH TENSILE SYNTHETIC TEXTILE AND STEEL WIRE HELIX.
 COVER : OIL, WEATHER, OZONE AND ABRASION RESISTANT, SPECIAL SYNTHETIC RUBBER.
 APPLICATION : SUCTION AND DISCHARGE OF MILK, VEGETABLE OIL AND BEVERAGES.



SEELE : GESCHMACKS- UND GERUCHSNEUTRAL, LEBENSMITTELECHT, SPEZIELLER SYNTHETISCHER NBR GUMMI, WEISS, SCHADSTOFFFREI, BESTÄNDIG GEGEN PFLANZLICHE ÖLE.
 EINLAGE : HOCHZUGFESTE SYNTHETISCHE TEXTILEINLAGE MIT EINER STAHLDRAHTSPIRALE.
 DECKE : ÖL-, OZON- UND WITTERUNGSBESTÄNDIGER, ABRIEBSFESTER, SPEZIELLER SYNTHETISCHER GUMMI.
 ANWENDUNG : SAUG-DRUCKSCHLAUCH FÜR MILCH, PFLANZLICHE ÖLE UND GETRÄNKE.



SOTTOSTRATO : GOMMA NBR BIANCA ATOSSICA, DI QUALITÀ ALIMENTARE INSAPORE ED INODORE, ADATTA PER IL PASSAGGIO DI LATTE, ED OLI VEGETALI.
 RINFORZO : INSERZIONI TESSILI AD ALTA TENACITÀ CON SPIRALE D'ACCIAIO.
 COPERTURA : GOMMA SPECIALE SINTETICA, RESISTANTE ALL'ABRASIONE, AGLI OLI, ALL'OZONO ED AGLI AGENTI ATMOSFERICI.
 IMPIEGO : ASPIRAZIONE E MANDATA DI PRODOTTI ALIMENTARI, GRASSI, E LATTE.



TUBE : CAOUTCHOUC NBR BLANC QUALITÉ ALIMENTAIRE, NON TOXIQUE, ANTI ODEUR ET NE TRANSMETTANT PAS DE GOUT, RESISTANT AUX HUILES VÉGÉTALES.
 RENFORCEMENT : INSERTION TEXTILE HAUTE TENACITÉ ET SPIRALE EN ACIER NOYÉE.
 REVÊTEMENT : CAOUTCHOUC SYNTHÉTIQUE SPÉCIAL, RESISTANT À L'ABRASION, À L'OZONE, AUX HUILES ET AUX AGENTS ATMOSPHÉRIQUES.
 APPLICATION : POUR L'ASPIRATION ET LE REFOULEMENT DE LAIT, DES HUILES VÉGÉTALES ET DES BOISSONS.

ID		OD	WP		BP		VACUUM	BR/r	W	L
inch	mm	mm	bar	psi	bar	psi	bar	mm	g/m	m
3/4"	19	31	10	145	30	435	-0.92	70	705	40-46-61
1"	25.4	38	10	145	30	435	-0.92	85	955	40-46-61
1 1/4"	32	45	10	145	30	435	-0.92	100	1225	40-46-61
1 1/2"	38	52	10	145	30	435	-0.92	120	1650	40-46-61
1 3/4"	44.5	58.5	10	145	30	435	-0.92	140	1830	40-46-61
2"	50.8	66	10	145	30	435	-0.92	160	2285	40-46-61
2 1/2"	63.5	78.5	10	145	30	435	-0.92	280	2797	40-46-61
3"	76.2	93	10	145	30	435	-0.92	360	3735	40-46-61
4"	101.6	118.5	10	145	30	435	-0.92	450	4725	40-46-61

Sanification : Max. 120 °C for 15 min. with steam, max. 50 °C for 15 min. with caustic soda (5%).
 Sterilisierung : Bei max. 120 °C für 15 min. mit dampf, bei max. 50 °C für 15 min. mit natronlauge (5%).
 Sanificazione : Massimo 120 °C per 15 minuti con vapore, massimo 50 °C per 15 minuti con soda caustica (5%).
 Sanification : 120 °C max. pendant 15 min. avec vapeur à 50 °C max. pendant 15 min. avec soude caustique (5%).



-40 °C / + 80 °C
 -40 °F / +176 °F

MARKING / BESCHRIFTUNG / MARCATURA / MARQUAGE: **TRANSFER TAPE OR EMBOSSED**

SEL KREMA SD/10 MILK & VEGETABLE OIL S/D HOSE - W.P. 10 Bar (145 PSI)

NORMS NORMEN NORME NORMES	ISO 1307 MEETS FDA REQUIREMENTS	COLOUR FARBEN COLORI COULEUR	
------------------------------------	------------------------------------	---------------------------------------	--

Beer & Wine Delivery



TUBE : WHITE COLOUR, NON-TOXIC, TASTE AND ODOUR FREE, EPDM RUBBER.
 REINFORCEMENT : HIGH TENSILE SYNTHETIC TEXTILE.
 COVER : WEATHER, OZONE AND ABRASION RESISTANT, SPECIAL SYNTHETIC RUBBER.
 APPLICATION : FOR DELIVERY OF BEVERAGES SUCH AS WINE, LIQUEUR, BEER, FRUIT JUICES, MINERAL WATER ETC.



SEELE : GESCHMACKS- UND GERUCHSNEUTRAL, SPEZIELLER EPDM GUMMI, WEISS, SCHADSTOFFFREI
 EINLAGE : HOCHZUGFESTE SYNTHETISCHE TEXTILEINLAGE.
 DECKE : OZON-UND WITTERUNGSBESTÄNDIGER, ABRIEBSFESTER, SPEZIELLER SYNTHETISCHER GUMMI.
 ANWENDUNG : ZUM DURCHLEITEN VON GETRÄNKEN WIE WEIN, BIER, FRUCHTSÄFTE, MINERALWASSER, LIKÖRE USW.



SOTTOSTRATO : GOMMA SPECIALE SINTETICA IN EPDM BIANCA ATOSSICA, DI QUALITÀ ALIMENTARE INSAPORE ED INODORE.
 RINFORZO : INSERZIONI TESSILI AD ALTA TENACITÀ.
 COPERTURA : GOMMA SPECIALE SINTETICA, RESISTENTE ALL'ABRASIONE, ALL'OZONO ED AGLI AGENTI ATMOSFERICI.
 IMPIEGO : PER MANDATA DI ALIMENTI COME: BIRRA, VINO, LIQUORI, ACQUA MINERALE, E SUCCHI DI FRUTTA ETC.



TUBE : CAOUTCHOUC EPDM COULEUR BLANCHE, NON TOXIQUE, ANTI ODEUR ET NE TRANSMETTANT PAS DE GOUT.
 RENFORCEMENT : INSERTION TEXTILE HAUTE TENACITE.
 REVETEMENT : CAOUTCHOUC SYNTHETIQUE SPECIAL, RESISTANT A L'ABRASION, A L'OZONE ET AUX AGENTS ATMOSPHERIQUES.
 APPLICATION : POUR REFOULEMENT DE BOISSONS TELLES QUE LE VIN, LES LIQUEURS, LA BIERE, L'EAU MINERALES, JUS DE FRUITS, ETC.

ID		OD		WP		BP		W	L
inch	mm	mm	bar	psi	bar	psi	g/m	m	

6 BAR

3/4"	19	28.5	6	87	18	261	472	40-46-61
1"	25.4	35	6	87	18	261	600	40-46-61
1 1/4"	32	43	6	87	18	261	887	40-46-61
1 1/2"	38	49	6	87	18	261	990	40-46-61
1 3/4"	44.5	55.5	6	87	18	261	1140	40-46-61
2"	50.8	62	6	87	18	261	1315	40-46-61
2 1/2"	63.5	75	6	87	18	261	1665	40-46-61
3"	76.2	89	6	87	18	261	2145	40-46-61
4"	101.6	115	6	87	18	261	2930	40-46-61

10 BAR

3/4"	19	30	10	145	30	435	556	40-46-61
1"	25.4	37	10	145	30	435	719	40-46-61
1 1/4"	32	44	10	145	30	435	945	40-46-61
1 1/2"	38	51	10	145	30	435	1186	40-46-61
1 3/4"	44.5	57.5	10	145	30	435	1360	40-46-61
2"	50.8	65	10	145	30	435	1657	40-46-61
2 1/2"	63.5	77.5	10	145	30	435	2078	40-46-61
3"	76.2	92	10	145	30	435	2680	40-46-61
4"	101.6	117.5	10	145	30	435	3544	40-46-61



-40°C / +120°C
 -40°F / +248°F

Sanification : Max. 130 °C for 15 min. with steam, max. 60 °C for 15 min. with caustic soda (5%).
 Sterilisierung : Bei max. 130 °C für 15 min. mit dampf, bei max. 60 °C für 15 min. mit natronlauge (5%).
 Sanificazione : Massimo 130 °C per 15 minuti con vapore, massimo 60 °C per 15 minuti con soda caustica (5%).
 Sanification : 130 °C max. pendant 15 min. avec vapeur à 60 °C max. pendant 15 min. avec soude caustique (5%).

MARKING / BESCHRIFTUNG / MARCATURA / MARQUAGE: **TRANSFER TAPE OR EMBOSSED**



NORMS NORMEN NORME NORMES	ISO 1307 MEETS FDA REQUIREMENTS	COLOUR FARBEN COLORI COULEUR			
------------------------------------	------------------------------------	---------------------------------------	--	--	--



Beer & Wine S&D



	TUBE : WHITE COLOUR, NON-TOXIC, TASTE AND ODOUR FREE, EPDM RUBBER. REINFORCEMENT : HIGH TENSILE SYNTHETIC TEXTILE AND STEEL WIRE HELIX. COVER : WEATHER, OZONE AND ABRASION RESISTANT, SPECIAL SYNTHETIC RUBBER. APPLICATION : FOR SUCTION AND DELIVERY OF BEVERAGES SUCH AS WINE, LIQUEUR, BEER, FRUIT JUICES, MINERAL WATER ETC.
	SEELE : GESCHMACKS- UND GERUCHSNEUTRAL, SPEZIELLER EPDM GUMMI, WEISS, SCHADSTOFFFREI. EINLAGE : HOCHZUGFESTE SYNTHETISCHE TEXTILEINLAGE MIT EINER STAHLDRAHTSPIRALE. DECKE : OZON-UND WITTERUNGSBESTÄNDIGER, ABRIEBSFESTER, SPEZIELLER SYNTHETISCHER GUMMI. ANWENDUNG : SAUG-DRUCKSCHLAUCH FÜR GETRÄNKE WIE WEIN, BIER, FRUCHTSÄFTE, MINERALWASSER, LIKÖRE USW.
	SOTTOSTRATO : GOMMA SPECIALE SINTETICA IN EPDM BIANCA ATOSSICA, DI QUALITÀ ALIMENTARE INSAPORE ED INODORE. RINFORZO : INSERZIONI TESSILI AD ALTA TENACITÀ CON SPIRALE METALLICA. COPERTURA : GOMMA SPECIALE SINTETICA, RESISTENTE ALL'ABRASIONE, ALL'OZONO ED AGLI AGENTI ATMOSFERICI. IMPIEGO : PER ASPIRAZIONE E MANDATA DI ALIMENTI COME: BIRRA, VINO, LIQUORI, ACQUA MINERALE, E SUCCHI DI FRUTTA ETC.
	TUBE : CAOUTCHOUC EPDM COULEUR BLANCHE, NON TOXIQUE, ANTI ODEUR ET NE TRANSMETTANT PAS DE GOUT. REINFORCEMENT : INSERTION TEXTILE HAUTE TENACITE ET SPIRALE EN ACIER NOYEE. RETEVEMENT : CAOUTCHOUC SYNTHETIQUE SPECIAL, RESISTANT A L'ABRASION, A L'OZONE ET AUX AGENTS ATMOSPHERIQUES. APPLICATION : POUR ASPIRATION ET REFOULEMENT DE BOISSONS TELLES QUE LE VIN, LES LIQUEURS, LA BIERE, L'EAU MINERALES, JUS DE FRUITS, ETC.

ID		OD		WP		BP		VACUUM	BR/r	W	L
inch	mm	mm	bar	psi	bar	psi	bar	mm	g/m	m	
6 BAR											
3/4"	19	29	6	87	18	261	-0.92	50	586	40-46-61	
1"	25.4	36	6	87	18	261	-0.92	70	760	40-46-61	
1 1/4"	32	43	6	87	18	261	-0.92	90	995	40-46-61	
1 1/2"	38	49	6	87	18	261	-0.92	100	1295	40-46-61	
1 3/4"	44.5	56	6	87	18	261	-0.92	120	1520	40-46-61	
2"	50.8	62.5	6	87	18	261	-0.92	140	1710	40-46-61	
2 1/2"	63.5	74.5	6	87	18	261	-0.92	260	2000	40-46-61	
3"	76.2	89	6	87	18	261	-0.92	310	2930	40-46-61	
4"	101.6	115	6	87	18	261	-0.92	420	4055	40-46-61	
10 BAR											
3/4"	19	30	10	145	30	435	-0.92	60	556	40-46-61	
1"	25.4	37	10	145	30	435	-0.92	75	719	40-46-61	
1 1/4"	32	44	10	145	30	435	-0.92	95	945	40-46-61	
1 1/2"	38	51	10	145	30	435	-0.92	110	1186	40-46-61	
1 3/4"	44.5	57.5	10	145	30	435	-0.92	130	1360	40-46-61	
2"	50.8	65	10	145	30	435	-0.92	150	1657	40-46-61	
2 1/2"	63.5	77.5	10	145	30	435	-0.92	280	2078	40-46-61	
3"	76.2	92	10	145	30	435	-0.92	340	2680	40-46-61	
4"	101.6	117.5	10	145	30	435	-0.92	450	3544	40-46-61	



-40°C / +120°C
-40°F / +248°F

Sanification : Max. 130 °C for 15 min. with steam, max. 60 °C for 15 min. with caustic soda (5%).
Sterilisierung : Bei max. 130 °C für 15 min. mit dampf, bei max. 60 °C für 15 min. mit natronlauge (5%).
Sanificazione : Massimo 130 °C per 15 minuti con vapore, massimo 60 °C per 15 minuti con soda caustica (5%).
Sanification : 130 °C max. pendant 15 min. avec vapeur à 60 °C max. pendant 15 min. avec soude caustique (5%).

MARKING / BESCHRIFTUNG / MARCATURA / MARQUAGE: **TRANSFER TAPE OR EMBOSSED**



NORMS NORMEN NORME NORMES	ISO 1307 MEETS FDA REQUIREMENTS	COLOUR FARBEN COLORI COULEUR			
------------------------------------	------------------------------------	---------------------------------------	--	--	--

Foodstuff Delivery

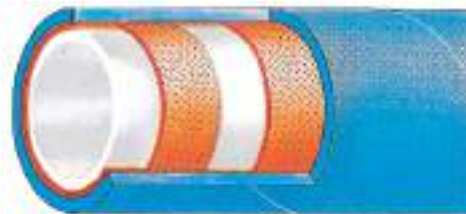

TUBE : WHITE COLOUR NON-TOXIC, TASTE AND ODOUR FREE, NATURAL RUBBER.
 REINFORCEMENT : HIGH TENSILE SYNTHETIC TEXTILE.
 COVER : WEATHER, OZONE AND ABRASION RESISTANT, SPECIAL SYNTHETIC RUBBER.
 APPLICATION : FOR DISCHARGE OF FOODSTUFF, SUCH AS WATER, FRUIT JUICES, ETC. NOT RECOMMENDED FOR OILY OR FATTY FOODS.



SEELE : GESCHMACKS- UND GERUCHSNEUTRAL, SPEZIELLER NATURGUMMI, WEISS, SCHADSTOFFFREI.
 EINLAGE : HOCHZUGFESTE SYNTHETISCHE TEXTILEINLAGE.
 DECKE : OZON-UND WITTERUNGSBESTÄNDIGER, ABRIEBSFESTER, SPEZIELLER SYNTHETISCHER GUMMI.
 ANWENDUNG : ZUM DURCHLEITEN VON GETRÄNKEN WIE WASSER, FRUCHTSÄFTE, USW. UNGEEIGNET FÜR ÖL- UND FETTHALTIGE PRODUKTE



SOTTOSTRATO : GOMMA NATURALE BIANCA ATOSSICA, DI QUALITÀ ALIMENTARE INSAPORE ED INODORE.
 RINFORZO : INSERZIONI TESSILI AD ALTA TENACITÀ.
 COPERTURA : GOMMA SPECIALE SINTETICA, RESISTENTE ALL'ABRASIONE, ALL'OZONO ED AGLI AGENTI ATMOSFERICI.
 IMPIEGO : PER MANDATA DI PRODOTTI ALIMENTARI COME, ACQUA, SUCCHI DI FRUTTA, ETC, NON CONSIGLIABILE PER PRODOTTI CONTENENTI GRASSI.



TUBE : CAOUTCHOUC NATURALE COULEUR BLANCHE, NON TOXIQUE, ANTI ODEUR ET NE TRANSMETTANT PAS DE GOUT.
 RENFORCEMENT : INSERTION TEXTILE HAUTE TENACITE.
 REVETEMENT : CAOUTCHOUC SYNTHETIQUE SPECIAL, RESISTANT A L'ABRASION, A L'OZONE ET AUX AGENTS ATMOSPHERIQUES.
 APPLICATION : POUR REFOULEMENT DE PRODUITS ALIMENTAIRES NON GRAS, EAUX, JUS DE FRUITS, ETC.

ID		OD		WP		BP		W	L
inch	mm	mm	mm	bar	psi	bar	psi	g/m	m

6 BAR

3/4"	19	28.5	6	87	18	261	531	40-46-61
1"	25.4	35	6	87	18	261	675	40-46-61
1 1/4"	32	43	6	87	18	261	994	40-46-61
1 1/2"	38	49	6	87	18	261	1142	40-46-61
1 3/4"	44.5	55.5	6	87	18	261	1315	40-46-61
2"	50.8	62	6	87	18	261	1510	40-46-61
2 1/2"	63.5	75	6	87	18	261	1870	40-46-61
3"	76.2	89	6	87	18	261	2418	40-46-61
4"	101.6	115	6	87	18	261	3315	40-46-61

10 BAR

3/4"	19	30	10	145	30	435	625	40-46-61
1"	25.4	37	10	145	30	435	810	40-46-61
1 1/4"	32	44	10	145	30	435	1055	40-46-61
1 1/2"	38	51	10	145	30	435	1335	40-46-61
1 3/4"	44.5	57.5	10	145	30	435	1530	40-46-61
2"	50.8	65	10	145	30	435	1870	40-46-61
2 1/2"	63.5	77.5	10	145	30	435	2285	40-46-61
3"	76.2	92	10	145	30	435	2975	40-46-61
4"	101.6	117.5	10	145	30	435	3935	40-46-61



-40°C / + 80°C
 -40°F / +176°F

Sanification : Max. 110 °C for 15 min. with steam, max. 40 °C for 15 min. with caustic soda (5%).
 Sterilisation : Bei max. 110 °C für 15 min. mit dampf, bei max. 40 °C für 15 min. mit natronlauge (5%).
 Sanificazione : Massimo 110 °C per 15 minuti con vapore, massimo 40 °C per 15 minuti con soda caustica (5%).
 Sanification : 110 °C max. pendant 15 min. avec vapeur à 40 °C max. pendant 15 min. avec soude caustique (5%).

MARKING / BESCHRIFTUNG / MARCATURA / MARQUAGE: **TRANSFER TAPE OR EMBOSSED**



NORMS NORMEN NORME NORMES	ISO 1307 MEETS FDA REQUIREMENTS	COLOUR FARBEN COLORI COULEUR	
------------------------------------	------------------------------------	---------------------------------------	--



Foodstuff S&D

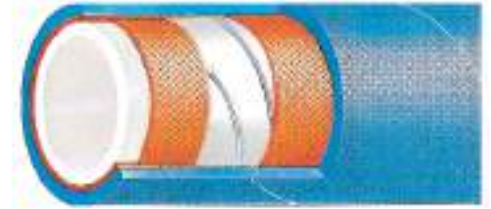

	TUBE : WHITE COLOUR NON-TOXIC, TASTE AND ODOUR FREE, NATURAL RUBBER. REINFORCEMENT : HIGH TENSILE SYNTHETIC TEXTILE AND STEEL WIRE HELIX. COVER : WEATHER, OZONE AND ABRASION RESISTANT, SPECIAL SYNTHETIC RUBBER. APPLICATION : FOR SUCTION AND DISCHARGE OF FOODSTUFF, SUCH AS WATER, FRUIT JUICES, ETC. NOT RECOMMENDED FOR OILY OR FATTY FOODS.
	SEELE : GESCHMACKS- UND GERUCHSNEUTRAL, SPEZIELLER NATURGUMMI, WEISS, SCHADSTOFFFREI. EINLAGE : HOCHZUGFESTE SYNTHETISCHE TEXTILEINLAGE MIT EINER STAHLDRAHTSPIRALE. DECKE : OZON-UND WITTERUNGSBESTÄNDIGER, ABRIEBSFESTER, SPEZIELLER SYNTHETISCHER GUMMI. ANWENDUNG : SAUG - DRUCKSCHLAUCH FÜR GETRÄNKE WIE WASSER, FRUCHTSÄFTE, USW. UNGEEIGNET FÜR ÖL- UND FETTHALTIGE PRODUKTE.
	SOTTOSTRATO : GOMMA NATURALE BIANCA ATOSSICA, DI QUALITÀ ALIMENTARE INSAPORE ED INODORE. RINFORZO : INSERZIONI TESSILI AD ALTA TENACITÀ CON SPIRALE D'ACCIAIO. COPERTURA : GOMMA SPECIALE SINTETICA, RESISTENTE ALL'ABRASIONE, ALL'OZONO ED AGLI AGENTI ATMOSFERICI. IMPIEGO : PER ASPIRAZIONE E MANDATA DI PRODOTTI ALIMENTARI COME, ACQUA, SUCCHI DI FRUTTA, ETC, NON CONSIGLIABILE PER PRODOTTI CONTENENTI GRASSI.
	TUBE : CAOUTCHOUC NATUREL COULEUR BLANCHE, NON TOXIQUE, ANTI ODEUR ET NE TRANSMETTANT PAS DE GOUT. REINFORCEMENT : INSERTION TEXTILE HAUTE TENACITE ET SPIRALE EN ACIER NOYEE. REVETEMENT : CAOUTCHOUC SYNTHETIQUE SPECIAL, RESISTANT A L'ABRASION, A L'OZONE ET AUX AGENTS ATMOSPHERIQUES. APPLICATION : POUR ASPIRATION ET REFOULEMENT DE PRODUITS ALIMENTAIRES NON GRAS, EAUX, JUS DE FRUITS, ETC.

ID		OD		WP		BP		VACUUM	BR/r	W	L
inch	mm	mm	bar	psi	bar	psi	bar	mm	g/m	m	
6 BAR											
3/4"	19	29	6	87	18	261	-0.92	50	650	40-46-61	
1"	25.4	36	6	87	18	261	-0.92	70	840	40-46-61	
1 1/4"	32	43	6	87	18	261	-0.92	85	1100	40-46-61	
1 1/2"	38	49	6	87	18	261	-0.92	100	1415	40-46-61	
1 3/4"	44.5	56	6	87	18	261	-0.92	120	1700	40-46-61	
2"	50.8	62.5	6	87	18	261	-0.92	140	1910	40-46-61	
2 1/2"	63.5	74.5	6	87	18	261	-0.92	250	2230	40-46-61	
3"	76.2	89	6	87	18	261	-0.92	310	3005	40-46-61	
4"	101.6	115	6	87	18	261	-0.92	420	4170	40-46-61	
10 BAR											
3/4"	19	30	10	145	30	435	-0.92	60	625	40-46-61	
1"	25.4	37	10	145	30	435	-0.92	75	810	40-46-61	
1 1/4"	32	44	10	145	30	435	-0.92	95	1055	40-46-61	
1 1/2"	38	51	10	145	30	435	-0.92	110	1335	40-46-61	
1 3/4"	44.5	57.5	10	145	30	435	-0.92	130	1530	40-46-61	
2"	50.8	65	10	145	30	435	-0.92	150	1870	40-46-61	
2 1/2"	63.5	77.5	10	145	30	435	-0.92	280	2285	40-46-61	
3"	76.2	92	10	145	30	435	-0.92	340	2975	40-46-61	
4"	101.6	117.5	10	145	30	435	-0.92	450	3935	40-46-61	



-40 °C / + 80 °C
-40 °F / +176 °F

Sanification : Max. 110 °C for 15 min. with steam, max. 40 °C for 15 min. with caustic soda (5%).
Sterilisation : Bei max. 110 °C für 15 min. mit dampf, bei max. 40 °C für 15 min. mit natronlauge (5%).
Sanificazione : Massimo 110 °C per 15 minuti con vapore, massimo 40 °C per 15 minuti con soda caustica (5%).
Sanification : 110 °C max. pendant 15 min. avec vapeur à 40 °C max. pendant 15 min. avec soude caustique (5%).

MARKING / BESCHRIFTUNG / MARCATURA / MARQUAGE: **TRANSFER TAPE OR EMBOSSED**



NORMS NORMEN NORME NORMES	ISO 1307 MEETS FDA REQUIREMENTS	COLOUR FARBEN COLORI COULEUR	
------------------------------------	------------------------------------	---------------------------------------	--

Foodstuff Delivery

UHMW-PE



TUBE : WHITE COLOUR NON-TOXIC, TASTE AND ODOUR FREE, UHMW-PE.
 REINFORCEMENT : HIGH TENSILE SYNTHETIC TEXTILE.
 COVER : WEATHER, OZONE AND ABRASION RESISTANT, SPECIAL SYNTHETIC RUBBER.
 APPLICATION : FOR DISCHARGE OF FOODSTUFF WITH HIGH PERCENTAGE OF ALCOHOL (UP TO 99%). FOR USE SPECIALLY IN BREWERIES, DISTILLERIES.



SEELE : GESCHMACKS- UND GERUCHSNEUTRAL, WEISS, SCHADSTOFFFREI, UHMW-PE.
 EINLAGE : HOCHZUGFESTE SYNTHETISCHE TEXTILEINLAGE.
 DECKE : OZON-UND WITTERUNGSBESTÄNDIGER, ABRIEBSFESTER, SPEZIELLER SYNTHETISCHER GUMMI.
 ANWENDUNG : ZUM DURCHLEITEN VON FLÜSSIGKEITEN MIT HOHEM ALKOHOLANTEIL (BIS ZU 99 %) SPEZIELL FÜR BRAUEREIEN UND BRENNEREIEN



SOTTOSTRATO : UHMW-PE ATOSSICO, DI QUALITÀ ALIMENTARE INSAPORATO ED INODORE.
 RINFORZO : INSERZIONI TESSILI AD ALTA TENACITÀ.
 COPERTURA : GOMMA SPECIALE SINTETICA, RESISTENTE ALL'ABRASIONE, ALL'OZONO ED AGLI AGENTI ATMOSFERICI.
 IMPIEGO : PER MANDATA DI PRODOTTI ALIMENTARI, VINI E ALCOOL FINO A 99%. PARTICOLARMENTE IDONEO PER L'USO NELLE BIRRERIE E NELLE DISTILLERIE.



TUBE : UHMW-PE COULEUR BLANCHE, NON TOXIQUE, ANTI ODEUR ET NE TRANSMETTANT PAS DE GOUT
 RENFORCEMENT : INSERTION TEXTILE HAUTE TENACITE.
 REVETEMENT : CAOUTCHOUC SYNTHETIQUE SPECIAL, RESISTANT A L'ABRASION, A L'OZONE ET AUX AGENTS ATMOSPHERIQUES.
 APPLICATION : POUR REFOULEMENT DES PRODUITS ALIMENTAIRES, VINS ET ALCOOL JUSQU'A 99%. PARTICULIEREMENT DANS LES BRASSERIES ET DISTILLERIES.

ID		OD		WP		BP		W	L
inch	mm	mm	mm	bar	psi	bar	psi	g/m	m
3/4"	19	30	30	10	145	30	435	545	40-46-61
1"	25.4	37	37	10	145	30	435	705	40-46-61
1 1/4"	32	44	44	10	145	30	435	915	40-46-61
1 1/2"	38	51	51	10	145	30	435	1135	40-46-61
1 3/4"	44.5	57.5	57.5	10	145	30	435	1300	40-46-61
2"	50.8	65	65	10	145	30	435	1635	40-46-61
2 1/2"	63.5	77.5	77.5	10	145	30	435	1890	40-46-61
3"	76.2	92	92	10	145	30	435	2580	40-46-61
4"	101.6	117.5	117.5	10	145	30	435	3500	40-46-61

Sanification : Max. 130 °C for 15 min. with steam, max. 60 °C for 15 min. with caustic soda (5%).
 Sterilisierung : Bei max. 130 °C für 15 min. mit dampf, bei max. 60 °C für 15 min. mit natronlauge (5%).
 Sanificazione : Massimo 130 °C per 15 minuti con vapore, massimo 60 °C per 15 minuti con soda caustica (5%).
 Sanification : 130 °C max. pendant 15 min. avec vapeur à 60 °C max. pendant 15 min. avec soude caustique (5%).



-40°C / + 80°C
 -40°F / +176°F

MARKING / BESCHRIFTUNG / MARCATURA / MARQUAGE: **TRANSFER TAPE OR EMBOSSED**

SEL RAKI D/10 PE FOODSTUFF DELIVERY HOSE - UHMW-PE - W.P. 10 Bar (145 PSI)

NORMS NORMEN NORME NORMES	ISO 1307 MEETS FDA REQUIREMENTS	COLOUR FARBEN COLORI COULEUR			
------------------------------------	------------------------------------	---------------------------------------	--	--	--

Foodstuff S&D



UHMW-PE



TUBE : WHITE COLOUR NON-TOXIC, TASTE AND ODOUR FREE, UHMW-PE.
 REINFORCEMENT : HIGH TENSILE SYNTHETIC TEXTILE AND STEEL WIRE HELIX.
 COVER : WEATHER, OZONE AND ABRASION RESISTANT, SPECIAL SYNTHETIC RUBBER.
 APPLICATION : FOR SUCTION AND DISCHARGE OF FOODSTUFF WITH HIGH PERCENTAGE OF ALCOHOL (UP TO 99%). FOR USE SPECIALLY IN BREWERIES, DISTILLERIES.



SEELE : GESCHMACKS- UND GERUCHSNEUTRAL, WEISS, SCHADSTOFFFREI, UHMW-PE.
 EINLAGE : HOCHZUGFESTE SYNTHETISCHE TEXTILEINLAGE MIT EINER STAHLDRAHTSPIRALE.
 DECKE : OZON-UND WITTERUNGSBESTÄNDIGER, ABRIEBSFESTER, SPEZIELLER SYNTHETISCHER GUMMI.
 ANWENDUNG : SAUG - DRUCKSCHLAUCH FÜR FLÜSSIGKEITEN MIT HOHEM ALKOHOLANTEIL (BIS ZU 99 %) SPEZIELL FÜR BRAUEREIEN UND BRENNEREIEN



SOTTOSTRATO : UHMW-PE ATOSSICO, DI QUALITÀ ALIMENTARE INSAPORE ED INODORE.
 RINFORZO : INSERZIONI TESSILI AD ALTA TENACITÀ CON SPIRALE D'ACCIAIO.
 COPERTURA : GOMMA SPECIALE SINTETICA , RESISTENTE ALL'ABRASIONE, ALL'OZONO ED AGLI AGENTI ATMOSFERICI.
 IMPIEGO : PER ASPIRAZIONE E MANDATA DI PRODOTTI ALIMENTARI, VINI E ALCOOL FINO A 99%. PARTICOLARMENTE IDONEO PER L'USO NELLE BIRRERIE E NELLE DISTILLERIE.



TUBE : UHMW-PE COULEUR BLANCHE, NON TOXIQUE, ANTI ODEUR ET NE TRANSMETTANT PAS DE GOUT.
 RENFORCEMENT : INSERTION TEXTILE HAUTE TENACITE ET SPIRALE EN ACIER NOYEE.
 REVETEMENT : CAOUTCHOUC SYNTHETIQUE SPECIAL, RESISTANT A L'ABRASION, A L'OZONE ET AUX AGENTS ATMOSPHERIQUES.
 APPLICATION : POUR ASPIRATION ET REFOULEMENT DES PRODUITS ALIMENTAIRES, VINS ET ALCOOL JUSQU'A 99%. PARTICULIEREMENT DANS LES BRASSERIES ET DISTILLERIES.

ID		OD		WP		BP		VACUUM	BR/r	W	L
inch	mm	mm	bar	psi	bar	psi	bar	mm	g/m	m	
3/4"	19	31	10	145	30	435	-0.92	75	650	40-46-61	
1"	25.4	38	10	145	30	435	-0.92	100	857	40-46-61	
1 1/4"	32	45	10	145	30	435	-0.92	150	1096	40-46-61	
1 1/2"	38	52	10	145	30	435	-0.92	200	1431	40-46-61	
1 3/4"	44.5	58.5	10	145	30	435	-0.92	260	1748	40-46-61	
2"	50.8	66	10	145	30	435	-0.92	300	2114	40-46-61	
2 1/2"	63.5	78.5	10	145	30	435	-0.92	400	2551	40-46-61	
3"	76.2	93	10	145	30	435	-0.92	800	3470	40-46-61	
4"	101.6	118.5	10	145	30	435	-0.92	1200	4511	40-46-61	

Sanification : Max. 130 °C for 15 min. with steam,
 max. 60 °C for 15 min. with caustic soda (5%).
 Sterilisierung : Bei max. 130 °C für 15 min. mit dampf,
 bei max. 60 °C für 15 min. mit natronlauge (5%).
 Sanificazione : Massimo 130 °C per 15 minuti con vapore,
 massimo 60 °C per 15 minuti con soda caustica (5%).
 Sanification : 130 °C max. pendant 15 min. avec vapeur à 60 °C max.
 pendant 15 min. avec soude caustique (5%).

OPTIONS / OPTIONEN / OPZIONI / OPTIONS

Upon Request : From 3/4" to 3" can be produced with PE helix
 Auf Anfrage : Kann in den Grössen 3/4" bis 3" mit PE produziert werden
 Su Richiesta : Da 3/4" a 3" possono essere prodotti con spirale di PE
 Sur Demande : De 3/4" Jusqu'a 3" peuvent être produits avec spirale en PE



-40°C / + 80°C
 -40°F / +176°F

MARKING / BESCHRIFTUNG / MARCATURA / MARQUAGE: **TRANSFER TAPE OR EMBOSSED**

SEL RAKI SD/10 PE FOODSTUFF S/D HOSE - UHMW-PE - W.P. 10 Bar (145 PSI)

NORMS
 NORMEN
 NORME
 NORMES

ISO 1307
 MEETS FDA REQUIREMENTS

COLOUR
 FARBEN
 COLORI
 COULEUR





Foodstuff S&D

FLAT-CORRUGATED UHMW-PE



 TUBE : WHITE COLOUR NON-TOXIC, TASTE AND ODOUR FREE, UHMW-PE.
 REINFORCEMENT : HIGH TENSILE SYNTHETIC TEXTILE AND STEEL WIRE HELIX.
 COVER : WEATHER, OZONE AND ABRASION RESISTANT, SPECIAL SYNTHETIC RUBBER. FLAT-CORRUGATED.
 APPLICATION : FOR SUCTION AND DISCHARGE OF FOODSTUFF WITH HIGH PERCENTAGE OF ALCOHOL (UP TO 99%). FOR USE SPECIALLY IN BREWERIES, DISTILLERIES.

 SEELE : GESCHMACKS- UND GERUCHSNEUTRAL, WEISS, SCHADSTOFFFREI, UHMW-PE.
 EINLAGE : HOCHZUGFESTE SYNTHETISCHE TEXTILEINLAGE MIT EINER STAHLDRAHTSPIRALE.
 DECKE : OZON-UND WITTERUNGSBESTÄNDIGER, ABRIEBSFESTER, SPEZIELLER SYNTHETISCHER GUMMI, LEICHT GEWELLT.
 ANWENDUNG : SAUG - DRUCKSCHLAUCH FÜR FLÜSSIGKEITEN MIT HOHEM ALKOHOLANTEIL (BIS ZU 99 %) SPEZIELL FÜR BRAUEREIEN UND BRENNEREIEN.

 SOTTOSTRATO : UHMW-PE ATOSSICO, DI QUALITÀ ALIMENTARE INSAPORE ED INODORE..
 RINFORZO : INSERZIONI TESSILI AD ALTA TENACITÀ CON SPIRALE D'ACCIAIO.
 COPERTURA : GOMMA SPECIALE SINTETICA ONDULATA PIATTA, RESISTENTE ALL'ABRASIONE, ALL'OZONO ED AGLI AGENTI ATMOSFERICI.
 IMPIEGO : PER ASPIRAZIONE E MANDATA DI PRODOTTI ALIMENTARI, VINI E ALCOOL FINO A 99%. PARTICOLARMENTE IDONEO PER L'USO NELLE BIRRERIE E NELLE DISTILLERIE.

 TUBE : UHMW-PE COULEUR BLANCHE, NON TOXIQUE, ANTI ODEUR ET NE TRANSMETTANT PAS DE GOUT.
 RENFORCEMENT : INSERTION TEXTILE HAUTE TENACITE ET SPIRALE EN ACIER NOYEE.
 REVETEMENT : CAOUTCHOUC SYNTHETIQUE SPECIAL, ONDULE PLAT, RESISTANT A L'ABRASION, A L'OZONE ET AUX AGENTS ATMOSPHERIQUES.
 APPLICATION : POUR ASPIRATION ET REFOULEMENT DES PRODUITS ALIMENTAIRES, VINS ET ALCOOL JUSQU'A 99%. PARTICULIEREMENT DANS LES BRASSERIES ET DISTILLERIES.



ID		OD		WP		BP		VACUUM	BR/r	W	L
inch	mm	mm	bar	psi	bar	psi	bar	mm	g/m	m	
3/4"	19	29	10	145	30	435	-0.92	70	480	40-46-61	
1"	25.4	36	10	145	30	435	-0.92	90	625	40-46-61	
1 1/4"	32	43	10	145	30	435	-0.92	130	910	40-46-61	
1 1/2"	38	50	10	145	30	435	-0.92	180	1060	40-46-61	
2"	50.8	64	10	145	30	435	-0.92	250	1525	40-46-61	
2 1/2"	63.5	78	10	145	30	435	-0.92	280	2145	40-46-61	
3"	76.2	91	10	145	30	435	-0.92	350	2550	40-46-61	
4"	101.6	119	10	145	30	435	-0.92	450	4210	40-46-61	
5"	127	148	10	145	30	435	-0.80	600	6475	40-46-61	

Sanification : Max. 130 °C for 15 min. with steam, max. 60 °C for 15 min. with caustic soda (5%).
 Sterilisierung : Bei max. 130 °C für 15 min. mit dampf, bei max. 60 °C für 15 min. mit natronlauge (5%).
 Sanificazione : Massimo 130 °C per 15 minuti con vapore, massimo 60 °C per 15 minuti con soda caustica (5%).
 Sanification : 130 °C max. pendant 15 min. avec vapeur à 60 °C max. pendant 15 min. avec soude caustique (5%).

 -40°C / + 80°C
 -40°F / +176°F

MARKING / BESCHRIFTUNG / MARCATURA / MARQUAGE: **TRANSFER TAPE OR EMBOSSED**

 **RAKI SDFC/10 PE** **FOODSTUFF S/D HOSE - UHMW-PE - W.P. 10 Bar (145 PSI)** 

NORMS NORMEN NORME NORMES	ISO 1307 MEETS FDA REQUIREMENTS	COLOUR FARBEN COLORI COULEUR	  
------------------------------------	------------------------------------	---------------------------------------	--

Abrasive Food

Abriebfester Lebensmittelschläuche

Prodotti Abrasivi Alimentari

Produits Abrasifs Alimentaires



Light Duty Bulk Food Delivery

FLAT



TUBE : WHITE COLOUR, NON-TOXIC, ABRASION RESISTANT NATURAL RUBBER.
 REINFORCEMENT : HIGH TENSILE SYNTHETIC TEXTILE AND ANTISTATIC COPPER WIRE.
 COVER : ABRASION, OZONE AND WEATHER RESISTANT SPECIAL SYNTHETIC RUBBER.
 APPLICATION : FOR DISCHARGE OF BULK ABRASIVE MATERIALS FOR FOOD INDUSTRY.



SEELE : WEISS, SCHADSTOFFFREI, ABRIEBFEST, NATURGUMMI.
 EINLAGE : HOCHZUGFESTE SYNTHETISCHE TEXTILEINLAGE UND ANTISTATISCHER KUPFERLITZE.
 DECKE : OZON-UND WITTERUNGSBESTÄNDIGER, ABRIEBFESTER, SPEZIELLER SYNTHETISCHER GUMMI.
 ANWENDUNG : GEEIGNET ZUR BEFÖRDERUNG VON ABRASIVEN MEDIEN IN DER LEBENSMITTELINDUSTRIE.



SOTTOSTRATO : GOMMA NATURALE BIANCA ATOSSICA RESISTENTE ALL'ABRASIONE.
 RINFORZO : INSERZIONI TESSILI AD ALTA TENACITÀ CON CORDICELLA DI RAME ANTISTATICA.
 COPERTURA : GOMMA SPECIALE SINTETICA NERA, RESISTENTE ALL'ABRASIONE, ALL'OZONO ED AGLI AGENTI ATMOSFERICI.
 IMPIEGO : PER MANDATA DI PRODOTTI ALIMENTARI ABRASIVI.



TUBE : CAOUTCHOUC NATUREL COULEUR BLANCHE, NON TOXIQUE, RESISTANT A L'ABRASION.
 RENFORCEMENT : INSERTION TEXTILE HAUTE TENACITE ET FIL DE MASSE ANTISTATIQUE.
 REVETEMENT : CAOUTCHOUC SYNTHETIQUE SPECIAL, RESISTANT A L'ABRASION, A L'OZONE ET AUX AGENTS ATMOSPHERIQUES.
 APPLICATION : POUR LE REFOULEMENT DE MATIERES ALIMENTAIRES ABRASIVES.

ID		OD	WP		BP		W	L
inch	mm	mm	bar	psi	bar	psi	g/m	m
2"	50.8	60.4	5	73	15	218	980	40-46-61
2 1/2"	63.5	73	5	73	15	218	1200	40-46-61
3"	76.2	86	5	73	15	218	1425	40-46-61
3 1/8"	80	90	5	73	15	218	1490	40-46-61
3 1/2"	90	100	5	73	15	218	1840	40-46-61
4"	101.6	112	5	73	15	218	2060	40-46-61
4 5/16"	110	120	5	73	15	218	2225	40-46-61
5"	127	137	5	73	15	218	2550	40-46-61
6"	152.4	164	5	73	15	218	3610	40-46-61
8"	203.2	215	5	73	15	218	4765	46



-40°C / + 70°C
 -40°F / +158°F

MARKING / BESCHRIFTUNG / MARCATURA / MARQUAGE: **TRANSFER TAPE OR EMBOSSED**

SEL WHITE-L LIGHT DUTY BULK FOOD DELIVERY HOSE W.P. 5 Bar (73 PSI)

NORMS NORMEN NORME NORMES	ISO 1307	COLOUR FARBEN COLORI COULEUR	
------------------------------------	----------	---------------------------------------	--

Heavy Duty Bulk Food Delivery



TUBE : WHITE COLOUR, NON-TOXIC, ABRASION RESISTANT NATURAL RUBBER.
 REINFORCEMENT : HIGH TENSILE SYNTHETIC TEXTILE AND ANTISTATIC COPPER WIRE.
 COVER : ABRASION, OZONE AND WEATHER RESISTANT PIN-PRICKED, SPECIAL SYNTHETIC RUBBER.
 APPLICATION : FOR DISCHARGE OF BULK ABRASIVE PRODUCTS. (SUGAR, FLOUR, MILK POWDER, GRANULES ETC)



SEELE : WEISS, SCHADSTOFFFREI, ABRIEBFEST, NATURGUMMI.
 EINLAGE : HOCHZUGFESTE SYNTHETISCHE TEXTILEINLAGE UND ANTISTATISCHER KUPFERLITZE.
 DECKE : OZON-UND WITTERUNGSBESTÄNDIGER, ABRIEBSFESTER, SPEZIELLER SYNTHETISCHER GUMMI, GEPRICKT.
 ANWENDUNG : GEEIGNET ZUR BEFÖRDERUNG VON ABRASIVEN MEDIEN WIE ZUCKER, MEHL, MILCHPULVER, GRANULATEN USW. IN DER LEBENSMITTELINDUSTRIE.



SOTTOSTRATO : GOMMA NATURALE BIANCA ATOSSICA RESISTENTE ALL'ABRASIONE.
 RINFORZO : INSERZIONI TESSILI AD ALTA TENACITÀ CON CORDICELLA DI RAME ANTISTATICA.
 COPERTURA : GOMMA SPECIALE SINTETICA NERA MICRO-FORATA, RESISTENTE ALL'ABRASIONE, ALL'OZONO ED AGLI AGENTI ATMOSFERICI.
 IMPIEGO : PER MANDATA DI PRODOTTI ALIMENTARI MOLTO ABRASIVI. (ZUCCHERO, FARINA, GRANULI, ETC)



TUBE : CAOUTCHOUC NATUREL COULEUR BLANCHE, NON TOXIQUE, RESISTANT A L'ABRASION.
 RENFORCEMENT : INSERTION TEXTILE HAUTE TENACITE ET FIL DE MASSE ANTISTATIQUE.
 REVETEMENT : CAOUTCHOUC SYNTHETIQUE SPECIAL MICRO-PERFORE, RESISTANT A L'ABRASION, A L'OZONE ET AUX AGENTS ATMOSPHERIQUES.
 APPLICATION : POUR REFOULEMENT DE MATIERES ABRASIVES EN VRAC (SUCRE, FARINE, POUDRE DE LAIT, GRANULES ETC.)

ID		OD	WP		BP		W	L
inch	mm	mm	bar	psi	bar	psi	g/m	m
1"	25.4	37	10	145	30	435	637	40-46-61
1 1/4"	32	44	10	145	30	435	837	40-46-61
1 1/2"	38	50	10	145	30	435	970	40-46-61
2"	50.8	64.5	10	145	30	435	1456	40-46-61
2 1/2"	63.5	77	10	145	30	435	1776	40-46-61
3"	76.2	90	10	145	30	435	2140	40-46-61
3 1/2"	90	104	10	145	30	435	2529	40-46-61
4"	101.6	118	10	145	30	435	3250	40-46-61
5"	127	146	10	145	30	435	4938	40-46-61
6"	152.4	172	10	145	30	435	6118	40-46-61
8"	203.2	225	10	145	30	435	8865	46
10"	254	276	10	145	30	435	11594	25

Abrasion loss value: Acc DIN 53516 ≤ 120 mm³
 Abriebwert nach DIN 53516 ≤ 120 mm³
 Perdita d'abrasione in accordo alla norma DIN 53516 ≤ 120 mm³
 Indice d'abrasion: Selon la norme DIN 53516 ≤ 120 mm³



-40°C / + 80°C
 -40°F / +176°F

MARKING / BESCHRIFTUNG / MARCATURA / MARQUAGE: **TRANSFER TAPE OR EMBOSSED**

SEL WHITE-HD HEAVY DUTY BULK FOOD DELIVERY HOSE W.P. 10 Bar (145 PSI)

NORMS NORMEN NORME NORMES	ISO 1307	COLOUR FARBEN COLORI COULEUR	
------------------------------------	----------	---------------------------------------	--

Heavy Duty Bulk Food S&D



TUBE : WHITE COLOUR, NON-TOXIC, ABRASION RESISTANT NATURAL RUBBER.
 REINFORCEMENT : HIGH TENSILE SYNTHETIC TEXTILE, STEEL WIRE HELIX AND ANTISTATIC COPPER WIRE.
 COVER : ABRASION, OZONE AND WEATHER RESISTANT PIN-PRICKED, SPECIAL SYNTHETIC RUBBER.
 APPLICATION : FOR SUCTION AND DISCHARGE OF BULK ABRASIVE PRODUCTS. (SUGAR, FLOUR, MILK POWDER, GRANULES ETC)



SEELE : WEISS, SCHADSTOFFFREI, ABRIEBFEST, NATURGUMMI.
 EINLAGE : HOCHZUGFESTE SYNTHETISCHE TEXTILEINLAGE, EINE STAHLDRAHTSPIRALE UND ANTISTATISCHER KUPFERLITZE.
 DECKE : OZON-UND WITTERUNGSBESTÄNDIGER, ABRIEBSFESTER, SPEZIELLER SYNTHETISCHER GUMMI, GEPRICKT.
 ANWENDUNG : SAUG - DRUCKSCHLAUCH ZUR BEFÖRDERUNG VON ABRASIVEN MEDIEN WIE ZUCKER, MEHL, MILCHPULVER, GRANULATEN USW.



SOTTOSTRATO : GOMMA NATURALE BIANCA ATOSSICA RESISTENTE ALL'ABRASIONE.
 RINFORZO : INSERZIONI TESSILI AD ALTA TENACITÀ CON SPIRALE D'ACCIAIO E CORDICELLA DI RAME ANTISTATICA.
 COPERTURA : GOMMA SPECIALE SINTETICA NERA MICRO-FORATA, RESISTENTE ALL'ABRASIONE, ALL'OZONO ED AGLI AGENTI ATMOSFERICI.
 IMPIEGO : PER ASPIRAZIONE E MANDATA DI PRODOTTI ALIMENTARI MOLTO ABRASIVI. (ZUCCHERO, FARINA, GRANULI, ETC)



TUBE : CAOUTCHOUC NATUREL COULEUR BLANCHE, NON TOXIQUE, RESISTANT A L'ABRASION.
 RENFORCEMENT : INSERTION TEXTILE HAUTE TENACITE, SPIRALE EN ACIER NOYEE ET FIL DE MASSE ANTISTATIQUE.
 REVETEMENT : CAOUTCHOUC SYNTHETIQUE SPECIAL MICRO-PERFORE, RESISTANT A L'ABRASION, A L'OZONO ET AUX AGENTS ATMOSPHERIQUES.
 APPLICATION : POUR ASPIRATION ET REFOULEMENT DE MATIERES ABRASIVES EN VRAC (SUCRE, FARINE, POUDRE DE LAIT, GRANULES ETC.)

ID		OD		WP		BP		VACUUM	BR/r	W	L
inch	mm	mm	mm	bar	psi	bar	psi	bar	mm	g/m	m
1"	25.4	39	39	10	145	30	435	-0.92	110	895	40-46-61
1 1/4"	32	45	45	10	145	30	435	-0.92	135	1064	40-46-61
1 1/2"	38	52	52	10	145	30	435	-0.92	160	1415	40-46-61
2"	50.8	66	66	10	145	30	435	-0.92	210	2005	40-46-61
2 1/2"	63.5	78.5	78.5	10	145	30	435	-0.92	270	2434	40-46-61
3"	76.2	92	92	10	145	30	435	-0.92	330	3155	40-46-61
3 1/2"	90	107	107	10	145	30	435	-0.92	410	3765	40-46-61
4"	101.6	120	120	10	145	30	435	-0.92	470	4630	40-46-61
5"	127	149	149	10	145	30	435	-0.92	600	6850	40-46-61
6"	152.4	174.5	174.5	10	145	30	435	-0.80	770	8910	40-46-61
8"	203.2	229	229	10	145	30	435	-0.80	1200	13800	30
10"	254	281	281	10	145	30	435	-0.80	1520	17315	10

Abrasion loss value: Acc DIN 53516 ≤ 120 mm³
 Abriebwert nach DIN 53516 ≤ 120 mm³
 Perdita d'abrasione in accordo alla norma DIN 53516 ≤ 120 mm³
 Indice d'abrasion: Selon la norme DIN 53516 ≤ 120 mm³



-40°C / + 80°C
 -40°F / +176°F

MARKING / BESCHRIFTUNG / MARCATURA / MARQUAGE: **TRANSFER TAPE OR EMBOSSED**



NORMS NORMEN NORME NORMES	ISO 1307	COLOUR FARBEN COLORI COULEUR	
------------------------------------	----------	---------------------------------------	--

Heavy Duty Bulk Food S&D

CORRUGATED



TUBE : WHITE COLOUR, NON-TOXIC, ABRASION RESISTANT NATURAL RUBBER.
 REINFORCEMENT : HIGH TENSILE SYNTHETIC TEXTILE, STEEL WIRE HELIX AND ANTISTATIC COPPER WIRE.
 COVER : ABRASION, OZONE AND WEATHER RESISTANT, CORRUGATED SPECIAL SYNTHETIC RUBBER.
 APPLICATION : FOR SUCTION AND DISCHARGE OF BULK ABRASIVE PRODUCTS. (SUGAR, FLOUR, MILK POWDER, GRANULES ETC).



SEELE : WEISS, SCHADSTOFFFREI, ABRIEBFEST, NATURGUMMI.
 EINLAGE : HOCHZUGFESTE SYNTHETISCHE TEXTILEINLAGE, EINE STAHLDRAHTSPIRALE UND ANTISTATISCHER KUPFERLITZE
 DECKE : OZON-UND WITTERUNGSBESTÄNDIGER, ABRIEBSFESTER, SPEZIELLER SYNTHETISCHER GUMMI, GEWELLT.
 ANWENDUNG : SAUG - DRUCKSCHLAUCH ZUR BEFÖRDERUNG VON ABRASIVEN MEDIEN WIE ZUCKER, MEHL, MILCHPULVER, GRANULATEN USW.



SOTTOSTRATO : GOMMA NATURALE BIANCA ATOSSICA RESISTENTE ALL'ABRASIONE.
 RINFORZO : INSERZIONI TESSILI AD ALTA TENACITÀ CON SPIRALE D'ACCIAIO E CORDICELLA DI RAME ANTISTATICA.
 COPERTURA : GOMMA SPECIALE SINTETICA NERA ONDULATA, RESISTENTE ALL'ABRASIONE, ALL'OZONO ED AGLI AGENTI ATMOSFERICI.
 IMPIEGO : PER ASPIRAZIONE E MANDATA DI PRODOTTI ALIMENTARI MOLTO ABRASIVI. (ZUCCHERO, FARINA, GRANULI, ETC)



TUBE : CAOUTCHOUC NATUREL COULEUR BLANCHE, NON TOXIQUE, RESISTANT A L'ABRASION.
 RENFORCEMENT : INSERTION TEXTILE HAUTE TENACITE, SPIRALE EN ACIER NOYEE ET FIL DE MASSE ANTISTATIQUE.
 REVETEMENT : CAOUTCHOUC SYNTHETIQUE SPECIAL, ONDULE, RESISTANT A L'ABRASION, A L'OZONO ET AUX AGENTS ATMOSPHERIQUES.
 APPLICATION : POUR ASPIRATION ET REFOULEMENT DE MATIERES ABRASIVES EN VRAC (SUCRE, FARINE, POUDRE DE LAIT, GRANULES ETC.)

ID		OD		WP		BP		VACUUM	BR/r	W	L
inch	mm	mm	mm	bar	psi	bar	psi	bar	mm	g/m	m
1"	25.4	37.5	10	145	30	435	-0.92	60	805	40-46-61	
1 1/4"	32	44	10	145	30	435	-0.92	75	975	40-46-61	
1 1/2"	38	51	10	145	30	435	-0.92	90	1294	40-46-61	
2"	50.8	64.5	10	145	30	435	-0.92	125	1779	40-46-61	
2 1/2"	63.5	77.5	10	145	30	435	-0.92	175	2387	40-46-61	
3"	76.2	90.5	10	145	30	435	-0.92	200	3080	40-46-61	
3 1/2"	90	106	10	145	30	435	-0.92	250	3860	40-46-61	
4"	101.6	119	10	145	30	435	-0.92	275	4660	40-46-61	
5"	127	147	10	145	30	435	-0.92	350	6830	40-46-61	
6"	152.4	173	10	145	30	435	-0.92	400	8960	40-46-61	
8"	203.2	227	10	145	30	435	-0.80	750	14090	30	
10"	254	279	10	145	30	435	-0.80	1100	17310	20	

Abrasion loss value: Acc DIN 53516 ≤ 120 mm³
 Abriebwert nach DIN 53516 ≤ 120 mm³
 Perdita d'abrasione in accordo alla norma DIN 53516 ≤ 120 mm³
 Indice d'abrasion: Selon la norme DIN 53516 ≤ 120 mm³



-40°C / + 80°C
 -40°F / +176°F

MARKING / BESCHRIFTUNG / MARCATURA / MARQUAGE: **TRANSFER TAPE OR EMBOSSED**

SEL WHITE - SDC HEAVY DUTY BULK FOOD S/D HOSE W.P. 10 Bar (145 PSI)

NORMS NORMEN NORME NORMES	ISO 1307	COLOUR FARBEN COLORI COULEUR	
------------------------------------	----------	---------------------------------------	--

Heavy Duty Bulk Food S&D

FLAT-CORRUGATED



TUBE : WHITE COLOUR, NON-TOXIC, ABRASION RESISTANT NATURAL RUBBER.
 REINFORCEMENT : HIGH TENSILE SYNTHETIC TEXTILE, STEEL WIRE HELIX AND ANTISTATIC COPPER WIRE.
 COVER : ABRASION, OZONE AND WEATHER RESISTANT, FLAT CORRUGATED SPECIAL SYNTHETIC RUBBER.
 APPLICATION : FOR SUCTION AND DISCHARGE OF BULK ABRASIVE PRODUCTS. (SUGAR, FLOUR, MILK POWDER, GRANULES ETC)



SEELE : WEISS, SCHADSTOFFFREI, ABRIEBFEST, NATURGUMMI.
 EINLAGE : HOCHZUGFESTE SYNTHETISCHE TEXTILEINLAGE, EINE STAHLDRAHTSPIRALE UND ANTISTATISCHER KUPFERLITZE.
 DECKE : OZON-UND WITTERUNGSBESTÄNDIGER, ABRIEBSFESTER, SPEZIELLER SYNTHETISCHER GUMMI, LEICHT GEWELLT.
 ANWENDUNG : SAUG - DRUCKSCHLAUCH ZUR BEFÖRDERUNG VON ABRASIVEN MEDIEN WIE ZUCKER, MEHL, MILCHPULVER, GRANULATEN USW.



SOTTOSTRATO : GOMMA NATURALE BIANCA ATOSSICA RESISTENTE ALL'ABRASIONE.
 RINFORZO : INSERZIONI TESSILI AD ALTA TENACITÀ CON SPIRALE D'ACCIAIO E CORDICELLA DI RAME ANTISTATICA.
 COPERTURA : GOMMA SPECIALE SINTETICA NERA ONDULATA PIATTA, RESISTENTE ALL'ABRASIONE, ALL'OZONO ED AGLI AGENTI ATMOSFERICI.
 IMPIEGO : PER ASPIRAZIONE E MANDATA DI PRODOTTI ALIMENTARI MOLTO ABRASIVI. (ZUCCHERO, FARINA, GRANULI, ETC)



TUBE : CAOUTCHOUC NATUREL COULEUR BLANCHE, NON TOXIQUE, RESISTANT A L'ABRASION.
 RENFORCEMENT : INSERTION TEXTILE HAUTE TENACITE, SPIRALE EN ACIER NOYEE ET FIL DE MASSE ANTISTATIQUE.
 REVETEMENT : CAOUTCHOUC SYNTHETIQUE SPECIAL, ONDULE PLAT, RESISTANT A L'ABRASION, A L'OZONO ET AUX AGENTS ATMOSPHERIQUES.
 APPLICATION : POUR ASPIRATION ET REFOULEMENT DE MATIERES ABRASIVES EN VRAC (SUCRE, FARINE, POUDRE DE LAIT, GRANULES ETC.)

ID		OD	WP		BP		VACUUM	BR/r	W	L
inch	mm	mm	bar	psi	bar	psi	bar	mm	g/m	m
1"	25.4	39	10	145	30	435	-0.92	50	810	40-46-61
1 1/4"	32	46	10	145	30	435	-0.92	60	1070	40-46-61
1 1/2"	38	54	10	145	30	435	-0.92	75	1445	40-46-61
2"	50.8	69	10	145	30	435	-0.92	100	2155	40-46-61
2 1/2"	63.5	81.5	10	145	30	435	-0.92	150	2735	40-46-61
3"	76.2	95	10	145	30	435	-0.92	175	3390	40-46-61
4"	101.6	121.5	10	145	30	435	-0.92	225	4835	40-46-61
5"	127	150	10	145	30	435	-0.92	325	7470	40-46-61
6"	152.4	176	10	145	30	435	-0.92	375	9580	40-46-61
8"	203.2	230	10	145	30	435	-0.80	600	13670	30

Abrasion loss value: Acc DIN 53516 ≤ 120 mm³
 Abriebwert nach DIN 53516 ≤ 120 mm³
 Perdita d'abrasione in accordo alla norma DIN 53516 ≤ 120 mm³
 Indice d'abrasion: Selon la norme DIN 53516 ≤ 120 mm³



-40°C / + 80°C
 -40°F / +176°F

MARKING / BESCHRIFTUNG / MARCATURA / MARQUAGE: **TRANSFER TAPE OR EMBOSSED**



NORMS NORMEN NORME NORMES	ISO 1307	COLOUR FARBEN COLORI COULEUR	
------------------------------------	----------	---------------------------------------	--



Heavy Duty Bulk Food S&D



CHANNELED



TUBE : WHITE COLOUR, NON-TOXIC, ABRASION RESISTANT NATURAL RUBBER.
 REINFORCEMENT : HIGH TENSILE SYNTHETIC TEXTILE, STEEL WIRE HELIX AND ANTISTATIC COPPER WIRE.
 COVER : ABRASION, OZONE AND WEATHER RESISTANT, CHANNELED SPECIAL SYNTHETIC RUBBER.
 APPLICATION : FOR SUCTION AND DISCHARGE OF BULK ABRASIVE PRODUCTS. (SUGAR, FLOUR, MILK POWDER, GRANULES ETC)



SEELE : WEISS, SCHADSTOFFFREI, ABRIEBFEST, NATURGUMMI.
 EINLAGE : HOCHZUGFESTE SYNTHETISCHE TEXTILEINLAGE, EINE STAHLDRAHTSPIRALE UND ANTISTATISCHER KUPFERLITZE.
 DECKE : OZON-UND WITTERUNGSBESTÄNDIGER, ABRIEBSFESTER, SPEZIELLER SYNTHETISCHER GUMMI, KORDELGERIPPT.
 ANWENDUNG : SAUG - DRUCKSCHLAUCH ZUR BEFÖRDERUNG VON ABRASIVEN MEDIEN WIE ZUCKER, MEHL, MILCHPULVER, GRANULATEN USW.



SOTTOSTRATO : GOMMA NATURALE BIANCA ATOSSICA RESISTENTE ALL'ABRASIONE.
 RINFORZO : INSERZIONI TESSILI AD ALTA TENACITÀ CON SPIRALE D'ACCIAIO E CORDICELLA DI RAME ANTISTATICA.
 COPERTURA : GOMMA SPECIALE SINTETICA NERA GRECATA, RESISTENTE ALL'ABRASIONE, ALL'OZONO ED AGLI AGENTI ATMOSFERICI.
 IMPIEGO : PER ASPIRAZIONE E MANDATA DI PRODOTTI ALIMENTARI MOLTO ABRASIVI. (ZUCCHERO, FARINA, GRANULI, ETC)



TUBE : CAOUTCHOUC NATUREL COULEUR BLANCHE, NON TOXIQUE, RESISTANT A L'ABRASION.
 RENFORCEMENT : INSERTION TEXTILE HAUTE TENACITE, SPIRALE EN ACIER NOYEE ET FIL DE MASSE ANTISTATIQUE.
 REVETEMENT : CAOUTCHOUC SYNTHETIQUE SPECIAL, ASPECT CRENELE, RESISTANT A L'ABRASION, A L'OZONO ET AUX AGENTS ATMOSPHERIQUES.
 APPLICATION : POUR ASPIRATION ET REFOULEMENT DE MATIERES ABRASIVES EN VRAC (SUCRE, FARINE, POUDRE DE LAIT, GRANULES ETC.)

ID		OD		WP		BP		VACUUM	BR/r	W	L
inch	mm	mm	mm	bar	psi	bar	psi	bar	mm	g/m	m
1"	25.4	36	10	145	30	435	-0.92	45	690	40-46-61	
1 1/4"	32	42.5	10	145	30	435	-0.92	55	896	40-46-61	
1 1/2"	38	48.4	10	145	30	435	-0.92	75	1040	40-46-61	
2"	50.8	62	10	145	30	435	-0.92	110	1561	40-46-61	
2 1/2"	63.5	76	10	145	30	435	-0.92	150	2132	40-46-61	
3"	76.2	89	10	145	30	435	-0.92	180	2513	40-46-61	
3 1/2"	90	104.5	10	145	30	435	-0.92	225	3476	40-46-61	
4"	101.6	117.5	10	145	30	435	-0.92	260	4188	40-46-61	
5"	127	145.5	10	145	30	435	-0.80	340	6440	40-46-61	
6"	152.4	172	10	145	30	435	-0.80	550	8130	40-46-61	

Abrasion loss value: Acc DIN 53516 ≤ 120 mm³
 Abriebwert nach DIN 53516 ≤ 120 mm³
 Perdita d'abrasione in accordo alla norma DIN 53516 ≤ 120 mm³
 Indice d'abrasion: Selon la norme DIN 53516 ≤ 120 mm³



-40°C / + 80°C
 -40°F / +176°F

MARKING / BESCHRIFTUNG / MARCATURA / MARQUAGE: **TRANSFER TAPE OR EMBOSSED**



NORMS NORMEN NORME NORMES	ISO 1307	COLOUR FARBEN COLORI COULEUR	
------------------------------------	----------	---------------------------------------	--

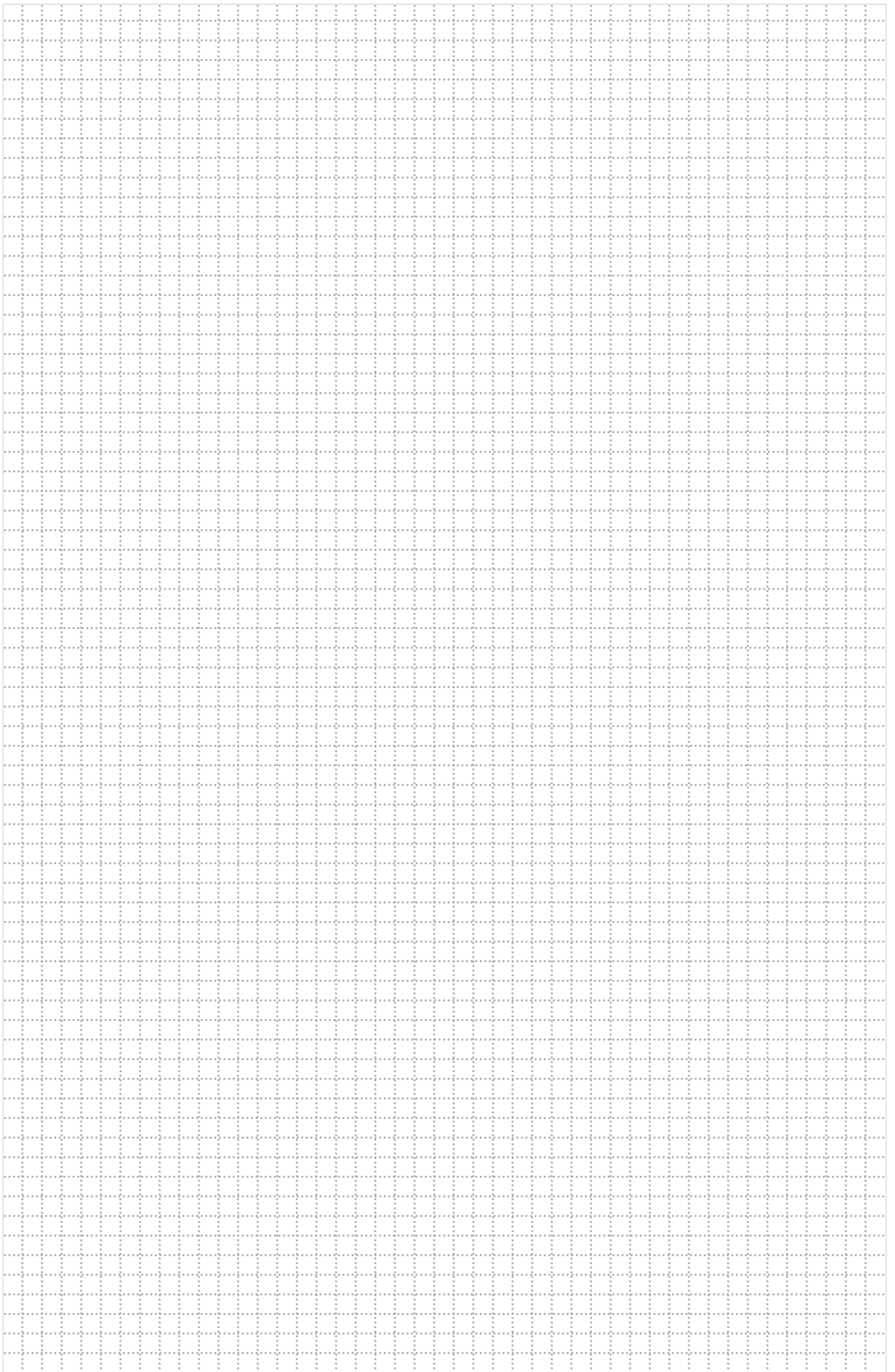

Oil & Petroleum

Öl und Kraftstoff

Prodotti Petroliferi

Hydrocarbures

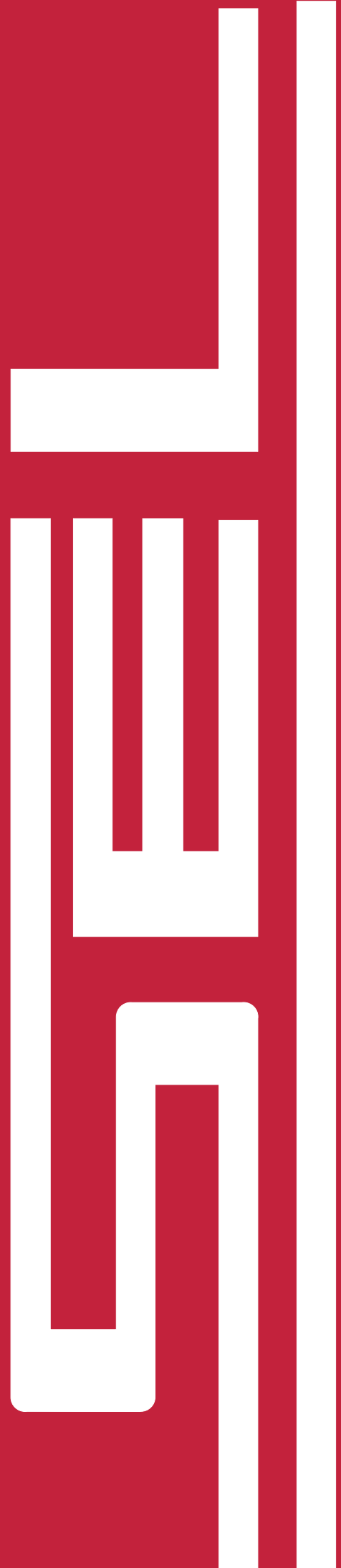
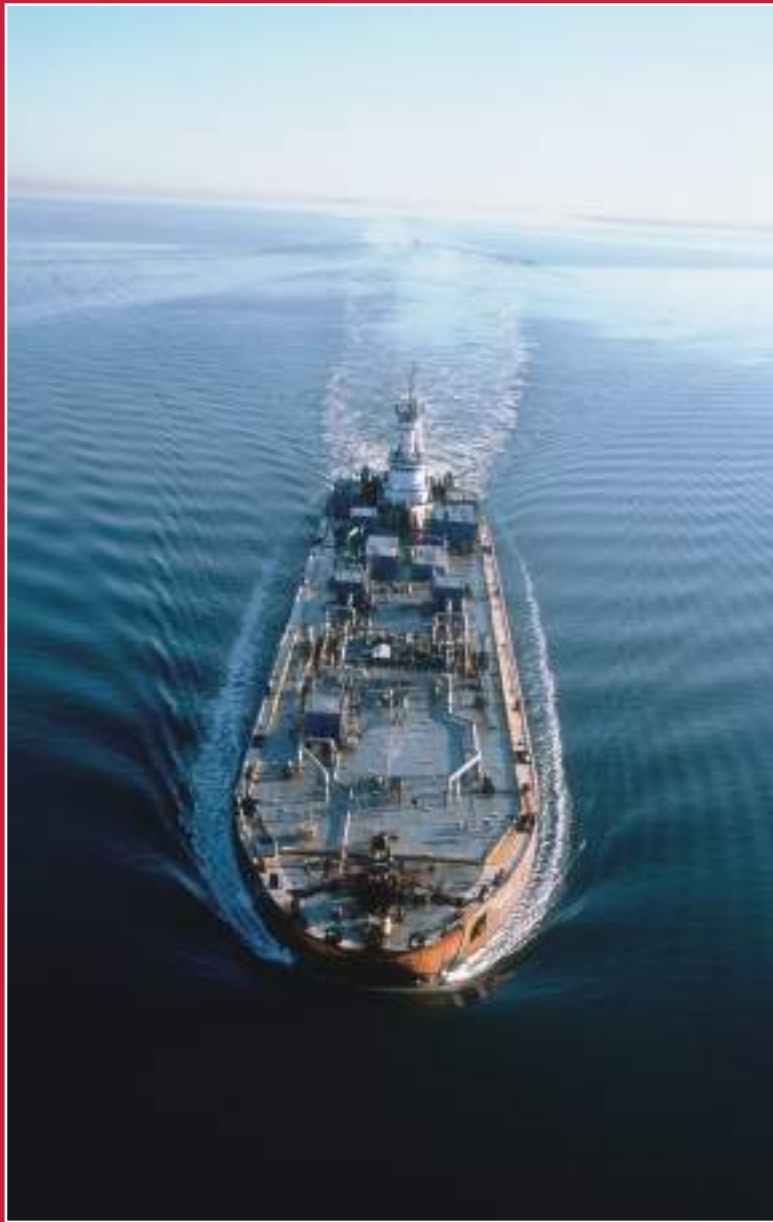

Oil Discharge 10 Bar



TUBE : OIL AND PETROL RESISTANT, BLACK NBR.
 REINFORCEMENT : HIGH TENSILE SYNTHETIC TEXTILE AND ANTISTATIC COPPER WIRE.
 COVER : ABRASION, OZONE, WEATHER AND OIL RESISTANT SPECIAL SYNTHETIC RUBBER.
 APPLICATION : FOR DELIVERY OF PETROLEUM PRODUCTS WITH AROMATIC CONTENT UP TO %50.



SEELE : ÖL-UND KRAFTSTOFFBESTÄNDIG, NITRILGUMMI, SCHWARZ.
 EINLAGE : HOCHZUGSFESTE SYNTHETISCHE TEXTILEINLAGE MIT ANTISTATISCHER KUPFERLITZE.
 DECKE : ABRIEB-, ÖL- UND WITTERUNGBESTÄNDIGER, SPEZIELLER SYNTHETIKGUMMI.
 ANWENDUNG : FÖRDERSCHLAUCH FÜR VERSCHIEDENE ÖLPRODUKTE MIT MAX. 50% AROMATENGEGHALT.



SOTTOSTRATO : GOMMA NBR NERA, RESISTENTE AI PRODOTTI PETROLIFERI.
 RINFORZO : INSERZIONI TESSILI AD ALTA TENACITÀ CON CORDICELLA DI RAME ANTISTATICA.
 COPERTURA : GOMMA SPECIALE NERA RESISTENTE AGLI OLI, ALL'OZONO, ALL' ABRASIONE ED AGLI AGENTI ATMOSFERICI.
 IMPIEGO : PER MANDATA DI PRODOTTI PETROLIFERI CON CONTENUTO AROMATICO FINO AL 50%.



TUBE : CAOUTCHOUC NBR, NOIR, RESISTANT AUX HUILES ET AUX HYDROCARBURES.
 RENFORCEMENT : INSERTION TEXTILE HAUTE TENACITE ET FIL DE MASSE ANTISTATIQUE.
 REVETEMENT : CAOUTCHOUC SYNTHETIQUE SPECIAL, RESISTANT AUX HUILES, A L'OZONE ET AUX AGENTS ATMOSPHERIQUES.
 APPLICATION : POUR REFOULEMENT D'HYDROCARBURES A TENEUR EN AROMATIQUES JUSQU'A 50%

ID		OD	WP		BP		W	L
inch	mm	mm	bar	psi	bar	psi	g/m	m
1"	25.4	35	10	145	30	435	574	40-46-61
1 1/4"	32	42	10	145	30	435	716	40-46-61
1 1/2"	38	48	10	145	30	435	864	40-46-61
1 3/4"	44.5	55	10	145	30	435	1064	40-46-61
2"	50.8	62	10	145	30	435	1276	40-46-61
2 1/2"	63.5	75	10	145	30	435	1632	40-46-61
3"	76.2	88	10	145	30	435	1984	40-46-61
3 1/2"	90	104	10	145	30	435	2723	40-46-61
4"	101.6	116	10	145	30	435	3193	40-46-61
5"	127	143	10	145	30	435	4463	40-46-61
6"	152.4	168	10	145	30	435	5253	40-46-61

OPTIONS / OPTIONEN / OPZIONI / OPTIONS

Tube upon request : Conductive (Ω)
 Seele nach Anfrage : Leitfähig (Ω)
 Sottostrato su richiesta : Conduttiva (Ω)
 Tube sur demande : Conducteur (Ω)



-30°C / + 70°C
 -22°F / +158°F

MARKING / BESCHRIFTUNG / MARCATURA / MARQUAGE: **TRANSFER TAPE OR EMBOSSED**



NORMS NORMEN NORME NORMES	ISO 1307	COLOUR FARBEN COLORI COULEUR	
------------------------------------	----------	---------------------------------------	--



Oil S&D 10 Bar



TUBE : OIL AND PETROL RESISTANT, BLACK NBR.
 REINFORCEMENT : HIGH TENSILE SYNTHETIC TEXTILE, STEEL WIRE HELIX AND ANTISTATIC COPPER WIRE.
 COVER : OIL, WEATHER, OZONE, ABRASION RESISTANT SPECIAL SYNTHETIC RUBBER.
 APPLICATION : FOR SUCTION AND DISCHARGE OF PETROLEUM PRODUCTS WITH AROMATIC CONTENT UP TO %50.



SEELE : ÖL- UND KRAFTSTOFFBESTÄNDIG, NITRILGUMMI, SCHWARZ.
 EINLAGE : HOCHZUGFESTE SYNTHETISCHE TEXTILEINLAGE, STAHLDRAHTSPIRALE UND ANTISTATISCHER KUPFERLITZE.
 DECKE : ÖL-, OZON- UND WITTERUNGSBESTÄNDIGER, ABRIEBFESTER, SPEZIELL SYNTHETISCHER GUMMI.
 ANWENDUNG : SAUG UND DRUCKSCHLAUCH FÜR MINERALÖLPRODUKTE MIT MAX. 50% AROMATENGEGHALT.



SOTTOSTRATO : GOMMA NBR NERA, RESISTENTE AI PRODOTTI PETROLIFERI.
 RINFORZO : INSERZIONI TESSILI AD ALTA TENACITÀ CON SPIRALE D'ACCIAIO E CORDICELLA DI RAME ANTISTATICA.
 COPERTURA : GOMMA SPECIALE SINTETICA NERA, RESISTENTE AGLI OLI, ALL'OZONO, ALL'ABRASIONE ED AGLI AGENTI ATMOSFERICI.
 IMPIEGO : PER ASPIRAZIONE E MANDATA DI PRODOTTI PETROLIFERI CON CONTENUTO AROMATICO FINO AL 50%.



TUBE : CAOUTCHOUC NBR, NOIR, RESISTANT AUX HUILES ET AUX HYDROCARBURES.
 REINFORCEMENT : INSERTION TEXTILE HAUTE TENACITE, SPIRALE EN ACIER ET FIL DE MASSE ANTISTATIQUE.
 REVETEMENT : CAOUTCHOUC SYNTHETIQUE SPECIAL, RESISTANT AUX HUILES, A L'ABRASION, A L'OZONE ET AUX AGENTS ATMOSPHERIQUES.
 APPLICATION : POUR ASPIRATION ET REFOULEMENT D'HYDROCARBURES A TENEUR EN AROMATIQUES JUSQU'A 50%.

ID		OD		WP		BP		VACUUM	BR/r	W	L
inch	mm	mm	mm	bar	psi	bar	psi	bar	mm	g/m	m
1"	25.4	36	36	10	145	30	435	-0.92	110	707	40-46-61
1 1/4"	32	43	43	10	145	30	435	-0.92	140	914	40-46-61
1 1/2"	38	49	49	10	145	30	435	-0.92	170	1155	40-46-61
1 3/4"	44.5	56	56	10	145	30	435	-0.92	210	1363	40-46-61
2"	50.8	63	63	10	145	30	435	-0.92	250	1644	40-46-61
2 1/2"	63.5	76	76	10	145	30	435	-0.92	310	2129	40-46-61
3"	76.2	89	89	10	145	30	435	-0.92	380	2768	40-46-61
3 1/2"	90	105	105	10	145	30	435	-0.92	450	3605	40-46-61
4"	101.6	117	117	10	145	30	435	-0.92	510	4035	40-46-61
5"	127	145	145	10	145	30	435	-0.80	650	6210	40-46-61
6"	152.4	170	170	10	145	30	435	-0.80	790	7750	40-46-61

OPTIONS / OPTIONEN / OPZIONI / OPTIONS

Tube upon request : Conductive (Ω)
 Seele nach Anfrage : Leitfähig (Ω)
 Sottostrato su richiesta : Conduttiva (Ω)
 Tube sur demande : Conducteur (Ω)



-30°C / + 70°C
 -22°F / +158°F

MARKING / BESCHRIFTUNG / MARCATURA / MARQUAGE: **TRANSFER TAPE OR EMBOSSED**



NORMS NORMEN NORME NORMES	ISO 1307	COLOUR FARBEN COLORI COULEUR	
------------------------------------	----------	---------------------------------------	--

Oil S&D 10 Bar

CORRUGATED



TUBE : OIL AND PETROL RESISTANT BLACK NBR.
 REINFORCEMENT : HIGH TENSILE SYNTHETIC TEXTILE, STEEL WIRE HELIX AND ANTISTATIC COPPER WIRE.
 COVER : OIL, WEATHER, OZONE, ABRASION AND SEA WATER RESISTANT. CORRUGATED SPECIAL SYNTHETIC RUBBER.
 APPLICATION : FOR SUCTION AND DISCHARGE OF PETROLEUM PRODUCTS WITH AROMATIC CONTENT UP TO 50%.



SEELE : ÖL- UND KRAFTSTOFFBESTÄNDIG, NITRILGUMMI, SCHWARZ.
 EINLAGE : HOCHZUGFESTE SYNTHETISCHE TEXTILEINLAGE, STAHLDRAHTSPIRALE UND ANTISTATISCHER KUPFERLITZE.
 DECKE : ÖL-, OZON- UND WITTERUNGSBESTÄNDIG, ABRIEBFEST, SPEZIELL SYNTHETISCHER GUMMI, GEWELLT, GEEIGNET FÜR EINSATZ IM SALZHALTIGEN WASSER.
 ANWENDUNG : SAUG UND DRUCKSCHLAUCH FÜR MINERALÖLPRODUKTE MIT MAX. 50% AROMATENGHALT.



SOTTOSTRATO : GOMMA NBR NERA, RESISTENTE AI PRODOTTI PETROLIFERI.
 RINFORZO : INSERZIONI TESSILI AD ALTA TENACITÀ CON SPIRALE D'ACCIAIO E CORDICELLA DI RAME ANTISTATICA.
 COPERTURA : GOMMA SPECIALE NERA ONDULATA, RESISTENTE AGLI OLI, ALL'OZONO, ALL'ABRASIONE ET AGLI AGENTI ATMOSFERICI ED ALL'ACQUA DI MARE.
 IMPIEGO : PER ASPIRAZIONE E MANDATA DI PRODOTTI PETROLIFERI CON CONTENUTO AROMATICO FINO AL 50%.



TUBE : CAOUTCHOUC NBR, NOIR, RESISTANT AUX HUILES ET AUX HYDROCARBURES.
 RENFORCEMENT : INSERTION TEXTILE HAUTE TENACITE, SPIRALE EN ACIER ET FIL DE MASSE ANTISTATIQUE.
 REVETEMENT : CAOUTCHOUC SYNTHETIQUE SPECIAL ONDULE, RESISTANT AUX HUILES, A L'ABRASION, A L'OZONE, AUX AGENTS ATMOSPHERIQUES ET A L'EAU DE MER.
 APPLICATION : POUR ASPIRATION ET REFOULEMENT D'HYDROCARBURES A TENEUR EN AROMATIQUES JUSQU'A 50%.

ID		OD		WP		BP		VACUUM	BR/r	W	L
inch	mm	mm	mm	bar	psi	bar	psi	bar	mm	g/m	m
3/4"	19	29		10	145	30	435	-0.92	75	572	40-46-61
1"	25.4	35		10	145	30	435	-0.92	100	684	40-46-61
1 1/4"	32	42		10	145	30	435	-0.92	120	826	40-46-61
1 1/2"	38	48		10	145	30	435	-0.92	140	965	40-46-61
2"	50.8	63		10	145	30	435	-0.92	190	1697	40-46-61
2 1/2"	63.5	74		10	145	30	435	-0.92	250	1980	40-46-61
3"	76.2	89		10	145	30	435	-0.92	300	2670	40-46-61
4"	101.6	116		10	145	30	435	-0.92	425	3860	40-46-61
5"	127	145		10	145	30	435	-0.80	550	6035	40-46-61
6"	152.4	172		10	145	30	435	-0.80	640	7572	40-46-61

OPTIONS / OPTIONEN / OPZIONI / OPTIONS

Tube upon request : Conductive (Ω)
 Seele nach Anfrage : Leitfähig (Ω)
 Sottostrato su richiesta : Conduttiva (Ω)
 Tube sur demande : Conducteur (Ω)



-30°C / + 70°C
 -22°F / +158°F

MARKING / BESCHRIFTUNG / MARCATURA / MARQUAGE: **TRANSFER TAPE OR EMBOSSED**

SEL YAKIT SDC / 10 OIL S / D HOSE - W.P. 10 Bar (145 PSI)



NORMS
 NORMEN
 NORME
 NORMES

ISO 1307

COLOUR
 FARBEN
 COLORI
 COULEUR



Oil S&D 10 Bar

FLAT CORRUGATED



TUBE : OIL AND PETROL RESISTANT BLACK NBR.
 REINFORCEMENT : HIGH TENSILE SYNTHETIC TEXTILE, STEEL WIRE HELIX AND ANTISTATIC COPPER WIRE.
 COVER : OIL, WEATHER, OZONE, ABRASION AND SEA WATER RESISTANT, FLAT-CORRUGATED, SPECIAL SYNTHETIC RUBBER.
 APPLICATION : FOR SUCTION AND DISCHARGE OF PETROLEUM PRODUCTS WITH AROMATIC CONTENT UP TO 50%.



SEELE : ÖL- UND KRAFTSTOFFBESTÄNDIG, NITRILGUMMI, SCHWARZ.
 EINLAGE : HOCHZUGFESTE SYNTHETISCHE TEXTILEINLAGE, STAHLDRAHTSPIRALE UND ANTISTATISCHER KUPFERLITZE.
 DECKE : ÖL-, OZON- UND WITTERUNGSBESTÄNDIG, ABRIEBFEST, SPEZIELL SYNTHETISCHER GUMMI, LEICHT GEWELLT, GEEIGNET FÜR EINSATZ IM SALZHALTIGEN WASSER.
 ANWENDUNG : SAUG UND DRUCKSCHLAUCH FÜR MINERALÖLPRODUKTE MIT MAX. 50 % AROMATENGEHALT.



SOTTOSTRATO : GOMMA NBR NERA, RESISTENTE AI PRODOTTI PETROLIFERI.
 RINFORZO : INSERZIONI TESSILI AD ALTA TENACITÀ CON SPIRALE D'ACCIAIO E CORDICELLA DI RAME ANTISTATICA.
 COPERTURA : GOMMA SPECIALE NERA ONDULATA PIATTA, RESISTENTE AGLI OLI, ALL'OZONO, ALL'ABRASIONE, AGLI AGENTI ATMOSFERICI ED ALL'ACQUA DI MARE.
 IMPIEGO : PER ASPIRAZIONE E MANDATA DI PRODOTTI PETROLIFERI CON CONTENUTO AROMATICO FINO AL 50%.



TUBE : CAOUTCHOUC NBR, NOIR, RESISTANT AUX HUILES ET AUX HYDROCARBURES.
 RENFORCEMENT : INSERTION TEXTILE HAUTE TENACITE, SPIRALE EN ACIER ET FIL DE MASSE ANTISTATIQUE..
 REVETEMENT : CAOUTCHOUC SYNTHETIQUE SPECIAL ONDULE PLAT, RESISTANT AUX HUILES, A L'ABRASION, A L'OZONE, AUX AGENTS ATMOSPHERIQUES ET A L'EAU DE MER.
 APPLICATION : POUR ASPIRATION ET REFOULEMENT D'HYDROCARBURES A TENEUR EN AROMATIQUES JUSQU'A 50%.

ID		OD		WP		BP		VACUUM	BR/r	W	L
inch	mm	mm	bar	psi	bar	psi	bar	mm	g/m	m	
3/4"	19	29	10	150	30	450	-0.92	65	463	40-46-61	
1"	25.4	36	10	150	30	450	-0.92	85	614	40-46-61	
1 1/4"	32	43	10	150	30	450	-0.92	110	852	40-46-61	
1 1/2"	38	49	10	150	30	450	-0.92	130	993	40-46-61	
2"	50.8	63	10	150	30	450	-0.92	175	1499	40-46-61	
2 1/2"	63.5	77	10	150	30	450	-0.92	210	2096	40-46-61	
3"	76.2	90	10	150	30	450	-0.92	250	2571	40-46-61	
4"	101.6	117	10	150	30	450	-0.92	360	3820	40-46-61	
5"	127	145	10	150	30	450	-0.80	480	6190	40-46-61	
6"	152.4	172	10	150	30	450	-0.80	600	8621	40-46-61	
8"	203.2	225	10	150	30	450	-0.80	900	12425	30	

OPTIONS / OPTIONEN / OPZIONI / OPTIONS



Tube upon request : Conductive (Ω)
 Seele nach Anfrage : Leitfähig (Ω)
 Sottostrato su richiesta : Conduttiva (Ω)
 Tube sur demande : Conducteur (Ω)



-30°C / + 70°C
 -22°F / +158°F

MARKING / BESCHRIFTUNG / MARCATURA / MARQUAGE: **TRANSFER TAPE OR EMBOSSED**



NORMS NORMEN NORME NORMES	ISO 1307	COLOUR FARBEN COLORI COULEUR	 
------------------------------------	----------	---------------------------------------	---

Oil S&D 10 Bar

CHANNELED



TUBE : OIL AND PETROL RESISTANT BLACK NBR.
 REINFORCEMENT : HIGH TENSILE SYNTHETIC TEXTILE, STEEL WIRE HELIX AND ANTISTATIC COPPER WIRE.
 COVER : OIL, WEATHER, OZONE, ABRASION AND SEA WATER RESISTANT, CHANNELED SPECIAL SYNTHETIC RUBBER.
 APPLICATION : FOR SUCTION AND DISCHARGE OF PETROLEUM PRODUCTS WITH AROMATIC CONTENT UP TO 50%.



SEELE : ÖL- UND KRAFTSTOFFBESTÄNDIG, NITRILGUMMI, SCHWARZ.
 EINLAGE : HOCHZUGFESTE SYNTHETISCHE TEXTILEINLAGE, STAHLDRAHTSPIRALE UND ANTISTATISCHER KUPFERLITZE.
 DECKE : ÖL-, OZON- UND WITTERUNGSBESTÄNDIG, ABRIEBFEST, SPEZIELL SYNTHETISCHER GUMMI, KORDELGERIPPT, GEEIGNET FÜR EINSATZ IM SALZHALTIGEN WASSER.
 ANWENDUNG : SAUG UND DRUCKSCHLAUCH FÜR MINERALÖLPRODUKTE MIT MAX. 50 % AROMATENGEHALT.



SOTTOSTRATO : GOMMA NBR NERA, RESISTENTE AI PRODOTTI PETROLIFERI.
 RINFORZO : INSERZIONI TESSILI AD ALTA TENACITÀ CON SPIRALE D'ACCIAIO E CORDICELLA DI RAME ANTISTATICA.
 COPERTURA : GOMMA SPECIALE NERA GRECATA, RESISTENTE AGLI OLI, ALL'OZONO, ALL'ABRASIONE, AGLI AGENTI ATMOSFERICI ED ALL'ACQUA DI MARE.
 IMPIEGO : PER ASPIRAZIONE E MANDATA DI PRODOTTI PETROLIFERI CON CONTENUTO AROMATICO FINO AL 50%.



TUBE : CAOUTCHOUC NBR, NOIR, RESISTANT AUX HUILES ET AUX HYDROCARBURES.
 RENFORCEMENT : INSERTION TEXTILE HAUTE TENACITE, SPIRALE EN ACIER ET FIL DE MASSE ANTISTATIQUE.
 REVETEMENT : CAOUTCHOUC SYNTHETIQUE SPECIAL ASPECT CRANELE, RESISTANT AUX HUILES, A L'ABRASION, A L'OZONE, AUX AGENTS ATMOSPHERIQUES ET A L'EAU DE MER.
 APPLICATION : POUR ASPIRATION ET REFOULEMENT D'HYDROCARBURES A TENEUR EN AROMATIQUES JUSQU'A 50%

ID		OD		WP		BP		VACUUM	BR/r	W	L
inch	mm	mm	mm	bar	psi	bar	psi	bar	mm	g/m	m
3/4"	19	29	10	145	30	435	-0.92	50	494	40-46-61	
1"	25.4	35	10	145	30	435	-0.92	70	601	40-46-61	
1 1/4"	32	42	10	145	30	435	-0.92	90	814	40-46-61	
1 1/2"	38	48	10	145	30	435	-0.92	105	948	40-46-61	
2"	50.8	63	10	145	30	435	-0.92	150	1584	40-46-61	
2 1/2"	63.5	74	10	145	30	435	-0.92	185	1786	40-46-61	
3"	76.2	90	10	145	30	435	-0.92	220	2570	40-46-61	
4"	101.6	117.5	10	145	30	435	-0.92	300	4234	40-46-61	
5"	127	146	10	145	30	435	-0.80	400	6018	40-46-61	
6"	152.4	172	10	145	30	435	-0.80	550	7063	40-46-61	

OPTIONS / OPTIONEN / OPZIONI / OPTIONS

Tube upon request : Conductive (Ω)
 Seele nach Anfrage : Leitfähig (Ω)
 Sottostrato su richiesta : Conduttiva (Ω)
 Tube sur demande : Conducteur (Ω)



-30°C / + 70°C
 -22°F / +158°F

MARKING / BESCHRIFTUNG / MARCATURA / MARQUAGE: **TRANSFER TAPE OR EMBOSSED**



NORMS NORMEN NORME NORMES	ISO 1307	COLOUR FARBEN COLORI COULEUR	
------------------------------------	----------	---------------------------------------	--



Oil Discharge 16 Bar



TUBE : OIL AND PETROL RESISTANT, BLACK NBR.
 REINFORCEMENT : HIGH TENSILE SYNTHETIC TEXTILE AND ANTISTATIC COPPER WIRE.
 COVER : ABRASION, OZONE, WEATHER AND OIL RESISTANT SPECIAL SYNTHETIC RUBBER.
 APPLICATION : FOR DELIVERY OF PETROLEUM PRODUCTS WITH AROMATIC CONTENT UP TO %50.



SEELE : ÖL-UND KRAFTSTOFFBESTÄNDIG, NITRILGUMMI, SCHWARZ.
 EINLAGE : HOCHZUGSFESTE SYNTHETISCHE TEXTILEINLAGE MIT ANTISTATISCHER KUPFERLITZE.
 DECKE : ÖL-, OZON UND WITTERUNGBESTÄNDIGER, SPEZIELLER SYNTHETIKGUMMI, ABRIEBFEST.
 ANWENDUNG : FÖRDERSCHLAUCH FÜR VERSCHIEDENE ÖLPRODUKTE MIT MAX. 50% AROMATENGHALT.



SOTTOSTRATO : GOMMA NBR NERA, RESISTENTE AI PRODOTTI PETROLIFERI.
 RINFORZO : INSERZIONI TESSILI AD ALTA TENACITÀ CON CORDICELLA DI RAME ANTISTATICA.
 COPERTURA : GOMMA SPECIALE NERA RESISTENTE AGLI OLI, ALL'OZONO, ALL'ABRASIONE ED AGLI AGENTI ATMOSFERICI.
 IMPIEGO : PER MANDATA DI PRODOTTI PETROLIFERI CON CONTENUTO AROMATICO FINO AL 50%.



TUBE : CAOUTCHOUC NBR, NOIR, RESISTANT AUX HUILES ET AUX HYDROCARBURES.
 REINFORCEMENT : INSERTION TEXTILE HAUTE TENACITE ET FIL DE MASSE ANTISTATIQUE.
 REVETEMENT : CAOUTCHOUC SYNTHETIQUE SPECIAL, RESISTANT AUX HUILES, A L'OZONE ET AUX AGENTS ATMOSPHERIQUES.
 APPLICATION : POUR REFOULEMENT D'HYDROCARBURES A TENEUR EN AROMATIQUES JUSQU'A 50%

ID		OD	WP		BP		W	L
inch	mm	mm	bar	psi	bar	psi	g/m	m
1"	25.4	36	16	232	48	696	652	40-46-61
1 1/4"	32	43	16	232	48	696	855	40-46-61
1 1/2"	38	49	16	232	48	696	965	40-46-61
1 3/4"	44.5	56	16	232	48	696	1230	40-46-61
2"	50.8	63	16	232	48	696	1390	40-46-61
2 1/2"	63.5	76	16	232	48	696	1790	40-46-61
3"	76.2	90	16	232	48	696	2325	40-46-61
3 1/2"	90	105	16	232	48	696	2957	40-46-61
4"	101.6	117	16	232	48	696	3350	40-46-61
5"	127	144	16	232	48	696	4550	40-46-61
6"	152.4	171	16	232	48	696	5960	40-46-61

OPTIONS / OPTIONEN / OPZIONI / OPTIONS

Tube upon request : Conductive (Ω)
 Seele nach Anfrage : Leitfähig (Ω)
 Sottostrato su richiesta : Conduttiva (Ω)
 Tube sur demande : Conducteur (Ω)



-30°C / + 70°C
 -22°F / +158°F

MARKING / BESCHRIFTUNG / MARCATURA / MARQUAGE: **TRANSFER TAPE OR EMBOSSED**



NORMS NORMEN NORME NORMES	ISO 1307	COLOUR FARBEN COLORI COULEUR	
------------------------------------	----------	---------------------------------------	--

Oil S&D 16 Bar



TUBE : OIL AND PETROL RESISTANT, BLACK NBR.
 REINFORCEMENT : HIGH TENSILE SYNTHETIC TEXTILE, STEEL WIRE HELIX AND ANTISTATIC COPPER WIRE.
 COVER : OIL, WEATHER, OZONE, ABRASION RESISTANT SPECIAL SYNTHETIC RUBBER.
 APPLICATION : FOR SUCTION AND DISCHARGE OF PETROLEUM PRODUCTS WITH AROMATIC CONTENT UP TO %50.



SEELE : ÖL-UND KRAFTSTOFFBESTÄNDIG, NITRILGUMMI, SCHWARZ.
 EINLAGE : HOCHZUGSFESTE SYNTHETISCHE TEXTILEINLAGE, STAHLDRAHTSPIRALE MIT ANTISTATISCHER KUPFERLITZE.
 DECKE : ÖL-, OZON UND WITTERUNGBESTÄNDIGER, SPEZIELLER SYNTHETIKGUMMI, ABRIEBFEST
 ANWENDUNG : SAUG UND DRUCKSCHLAUCH FÜR VERSCHIEDENE ÖLPRODUKTE MIT MAX. 50% AROMATENGEGHALT



SOTTOSTRATO : GOMMA NBR NERA, RESISTENTE AI PRODOTTI PETROLIFERI.
 RINFORZO : INSERZIONI TESSILI AD ALTA TENACITÀ CON SPIRALE D'ACCIAIO E CORDICELLA DI RAME ANTISTATICA.
 COPERTURA : GOMMA SPECIALE SINTETICA NERA, RESISTENTE AGLI OLI, ALL'OZONO, ALL'ABRASIONE ED AGLI AGENTI ATMOSFERICI
 IMPIEGO : PER ASPIRAZIONE E MANDATA DI PRODOTTI PETROLIFERI CON CONTENUTO AROMATICO FINO AL 50%.



TUBE : CAOUTCHOUC NBR, NOIR, RESISTANT AUX HUILES ET AUX HYDROCARBURES.
 RENFORCEMENT : INSERTION TEXTILE HAUTE TENACITE, SPIRALE EN ACIER ET FIL DE MASSE ANTISTATIQUE.
 REVETEMENT : CAOUTCHOUC SYNTHETIQUE SPECIAL, RESISTANT AUX HUILES, A L'ABRASION, A L'OZONE ET AUX AGENTS ATMOSPHERIQUES.
 APPLICATION : POUR ASPIRATION ET REFOULEMENT D'HYDROCARBURES A TENEUR EN AROMATIQUES JUSQU'A 50%

ID		OD		WP		BP		VACUUM	BR/r	W	L
inch	mm	mm	bar	psi	bar	psi	bar	mm	g/m	m	
1"	25.4	37	16	232	48	696	-0.92	110	795	40-46-61	
1 1/4"	32	44	16	232	48	696	-0.92	145	1042	40-46-61	
1 1/2"	38	51	16	232	48	696	-0.92	180	1366	40-46-61	
1 3/4"	44.5	58	16	232	48	696	-0.92	220	1620	40-46-61	
2"	50.8	65	16	232	48	696	-0.92	265	1885	40-46-61	
2 1/2"	63.5	79	16	232	48	696	-0.92	330	2475	40-46-61	
3"	76.2	92	16	232	48	696	-0.92	400	3255	40-46-61	
3 1/2"	90	107	16	232	48	696	-0.92	475	4025	40-46-61	
4"	101.6	118	16	232	48	696	-0.92	535	4305	40-46-61	
5"	127	148	16	232	48	696	-0.80	685	7035	40-46-61	
6"	152.4	175.5	16	232	48	696	-0.80	840	9625	40-46-61	

OPTIONS / OPTIONEN / OPZIONI / OPTIONS

Tube upon request : Conductive (Ω)
 Seele nach Anfrage : Leitfähig (Ω)
 Sottostrato su richiesta : Conduttiva (Ω)
 Tube sur demande : Conducteur (Ω)



-30°C / + 70°C
 -22°F / +158°F

MARKING / BESCHRIFTUNG / MARCATURA / MARQUAGE: **TRANSFER TAPE OR EMBOSSED**



NORMS NORMEN NORME NORMES	ISO 1307	COLOUR FARBEN COLORI COULEUR	
------------------------------------	----------	---------------------------------------	--



Oil Discharge 16 Bar

EN 1360 Type 1



TUBE : OIL AND PETROL RESISTANT BLACK NBR.
 REINFORCEMENT : HIGH TENSILE SYNTHETIC TEXTILE AND ANTISTATIC COPPER WIRE.
 COVER : ABRASION, OZONE, WEATHER, FLAME, HEAT, GASOLINE AND OIL RESISTANT SPECIAL SYNTHETIC RUBBER.
 APPLICATION : FOR DELIVERY OF PETROLEUM PRODUCTS WITH AROMATIC CONTENT UP TO %50.



SEELE : ÖL-UND KRAFTSTOFFBESTÄNDIG, NITRILGUMMI, SCHWARZ.
 EINLAGE : HOCHZUGSFESTE SYNTHETISCHE TEXTILEINLAGE MIT ANTISTATISCHER KUPFERLITZE.
 DECKE : ABRIEBFESTER, HITZE-, ÖL-, OZON- UND WITTERUNGBESTÄNDIGER, FLAMMWIDRIGER, SPEZIELLER SYNTHETIKGUMMI, BESTÄNDIG GEGEN KRAFTSTOFFE
 ANWENDUNG : FÖRDERSCHLAUCH FÜR VERSCHIEDENE ÖLPRODUKTE MIT MAX. 50% AROMATENGHALT



SOTTOSTRATO : GOMMA NBR NERA, RESISTENTE AI PRODOTTI PETROLIFERI.
 RINFORZO : INSERZIONI TESSILI AD ALTA TENACITÀ CON CORDICELLA DI RAME ANTISTATICA.
 COPERTURA : GOMMA SPECIALE SINTETICA NERA, RESISTENTE AGLI OLI, ALL'OZONO, ALL'ABRASIONE ED AGLI AGENTI ATMOSFERICI
 IMPIEGO : PER MANDATA DI PRODOTTI PETROLIFERI CON CONTENUTO AROMATICO FINO AL 50%.



TUBE : CAOUTCHOUC NBR, NOIR, RESISTANT AUX HUILES ET AUX HYDROCARBURES.
 REINFORCEMENT : INSERTION TEXTILE HAUTE TENACITE ET FIL DE MASSE ANTISTATIQUE.
 REVETEMENT : CAOUTCHOUC SYNTHETIQUE SPECIAL, RESISTANT AUX HUILES, A L'OZONE ET AUX AGENTS ATMOSPHERIQUES.
 APPLICATION : POUR REFOULEMENT D'HYDROCARBURES A TENEUR EN AROMATIQUES JUSQU'A 50%

ID		OD		WP		BP		BR/r	W	L
inch	mm	mm	mm	bar	psi	bar	psi	mm	g/m	m
1/2"	12.7	21.5	16	232	48	696	60	342	40-46-61	
5/8"	16	26	16	232	48	696	80	480	40-46-61	
3/4"	19	29	16	232	48	696	100	530	40-46-61	
1"	25.4	36	16	232	48	696	150	740	40-46-61	
1 1/4"	32	45	16	232	48	696	175	1100	40-46-61	
1 1/2"	38	51	16	232	48	696	225	1235	40-46-61	
1 9/16"	40	53	16	232	48	696	225	1292	40-46-61	

OPTIONS / OPTIONEN / OPZIONI / OPTIONS

- Tube upon request : Conductive (Ω)
- Seele nach Anfrage : Leitfähig (Ω)
- Sottostrato su richiesta : Conduttiva (Ω)
- Tube sur demande : Conducteur (Ω)



-30°C / + 70°C
 -22°F / +158°F



MARKING / BESCHRIFTUNG / MARCATURA / MARQUAGE: **TRANSFER TAPE OR EMBOSSED**

SEL **BARREL/16** OIL DISCHARGE HOSE - TS EN 1360 - Type 1 - M - NT - W.P. 16 BAR (232 PSI)

NORMS NORMEN NORME NORMES	TS EN 1360 TYPE 1 - CAT:M ISO 1307	COLOUR FARBEN COLORI COULEUR	
------------------------------------	---------------------------------------	---------------------------------------	--

Oil S&D16 Bar

EN 1360 Type 2



TUBE : OIL AND PETROL RESISTANT BLACK NBR.
 REINFORCEMENT : HIGH TENSILE SYNTHETIC TEXTILE, STEEL WIRE HELIX AND ANTISTATIC COPPER WIRE.
 COVER : ABRASION, OZONE, WEATHER, FLAME, HEAT, GASOLINE, OIL AND SEAWATER RESISTANT SPECIAL SYNTHETIC RUBBER.
 APPLICATION : FOR SUCTION AND DISCHARGE OF PETROLEUM PRODUCTS WITH AROMATIC CONTENT UP TO %50.



SEELE : ÖL-UND KRAFTSTOFFBESTÄNDIG, NITRILGUMMI, SCHWARZ.
 EINLAGE : HOCHZUGSFESTE SYNTHETISCHE TEXTILEINLAGE, STAHLDRAHTSPIRALE MIT ANTISTATISCHER KUPFERLITZE.
 DECKE : ABRIEBFESTER, HITZE-, ÖL-, OZON- UND WITTERUNGBESTÄNDIGER, FLAMMWIDRIGER, SPEZIELLER SYNTHETIKGUMMI, BESTÄNDIG GEGEN KRAFTSTOFFE
 ANWENDUNG : SAUG UND DRUCKSCHLAUCH FÜR VERSCHIEDENE ÖLPRODUKTE MIT MAX. 50% AROMATENGEHALT



SOTTOSTRATO : GOMMA NBR NERA, RESISTENTE AI PRODOTTI PETROLIFERI.
 RINFORZO : INSERZIONI TESSILI AD ALTA TENACITÀ CON SPIRALE D'ACCIAIO E CORDICELLA DI RAME ANTISTATICA.
 COPERTURA : GOMMA SPECIALE NERA, RESISTENTE AGLI OLI, ALL'OZONO, ALL'ABRASIONE, AGLI AGENTI ATMOSFERICI ED ALL'ACQUA DI MARE.
 IMPIEGO : PER ASPIRAZIONE E MANDATA DI PRODOTTI PETROLIFERI CON CONTENUTO AROMATICO FINO AL 50%.



TUBE : CAOUTCHOUC NBR, NOIR, RESISTANT AUX HUILES ET AUX HYDROCARBURES.
 RENFORCEMENT : INSERTION TEXTILE HAUTE TENACITE, SPIRALE EN ACIER ET FIL DE MASSE ANTISTATIQUE.
 REVETEMENT : CAOUTCHOUC SYNTHETIQUE SPECIAL, RESISTANT AUX HUILES, A L'ABRASION, A L'OZONE, AUX AGENTS ATMOSPHERIQUES ET A L'EAU DE MER.
 APPLICATION : POUR ASPIRATION ET REFOULEMENT D'HYDROCARBURES A TENEUR EN AROMATIQUES JUSQU'A 50%

ID		OD		WP		BP		VACUUM	BR/r	W	L
inch	mm	mm	mm	bar	psi	bar	psi	bar	mm	g/m	m
3/4"	19	30	16	232	48	696	-0.92	100	625	40-46-61	
1"	25.4	38	16	232	48	696	-0.92	150	930	40-46-61	
1 1/4"	32	45	16	232	48	696	-0.92	175	1180	40-46-61	
1 1/2"	38	51	16	232	48	696	-0.92	225	1445	40-46-61	
1 9/16"	40	54	16	232	48	696	-0.92	225	1660	40-46-61	

OPTIONS / OPTIONEN / OPZIONI / OPTIONS

Tube upon request : Conductive (Ω)
 Seele nach Anfrage : Leitfähig (Ω)
 Sottostrato su richiesta : Conduttiva (Ω)
 Tube sur demande : Conducteur (Ω)



-30°C / + 70°C
 -22°F / +158°F



MARKING / BESCHRIFTUNG / MARCATURA / MARQUAGE: **TRANSFER TAPE OR EMBOSSED**

SEL BARREL SD/16 OIL S / D HOSE - TS EN 1360 - Type 2 - M - NT - W.P. 16 BAR (232 PSI)

NORMS NORMEN NORME NORMES	TS EN 1360 TYPE 2 - CAT: M ISO 1307	COLOUR FARBEN COLORI COULEUR	
------------------------------------	--	---------------------------------------	--



Oil Discharge 16 Bar

EN 1761 Type D



TUBE : OIL AND PETROL RESISTANT BLACK NBR.
 REINFORCEMENT : HIGH TENSILE SYNTHETIC TEXTILE AND 2 ANTISTATIC COPPER WIRE.
 COVER : ABRASION, OZONE, WEATHER, FLAME, HEAT, GASOLINE AND OIL RESISTANT SPECIAL SYNTHETIC RUBBER.
 APPLICATION : FOR DELIVERY OF PETROLEUM PRODUCTS WITH AROMATIC CONTENT UP TO %50.



SEELE : ÖL-UND KRAFTSTOFFBESTÄNDIG, NITRILGUMMI, SCHWARZ.
 EINLAGE : HOCHZUGSFESTE SYNTHETISCHE TEXTILEINLAGE MIT 2 ANTISTATISCHE KUPFERLITZEN.
 DECKE : ABRIEBFESTER, HITZE-, ÖL-, OZON- UND WITTERUNGBESTÄNDIGER, FLAMMWIDRIGER, SPEZIELLER SYNTHETIKGUMMI, BESTÄNDIG GEGEN KRAFTSTOFFE.
 ANWENDUNG : FÖRDERSCHLAUCH FÜR VERSCHIEDENE ÖLPRODUKTE MIT MAX. 50% AROMATENGHEALT.



SOTTOSTRATO : GOMMA NBR NERA, RESISTENTE AI PRODOTTI PETROLIFERI.
 RINFORZO : INSERZIONI TESSILI AD ALTA TENACITÀ CON 2 CORDICELLE DI RAME ANTISTATICHE.
 COPERTURA : GOMMA SPECIALE SINTETICA NERA, RESISTENTE AGLI OLI, ALL'OZONO, ALL'ABRASIONE ED AGLI AGENTI ATMOSFERICI
 IMPIEGO : PER MANDATA DI PRODOTTI PETROLIFERI CON CONTENUTO AROMATICO FINO AL 50%.



TUBE : CAOUTCHOUC NBR, NOIR, RESISTANT AUX HUILES ET AUX HYDROCARBURES.
 RENFORCEMENT : INSERTION TEXTILE HAUTE TENACITE ET 2 FILS DE MASSE ANTISTATIQUES.
 REVETEMENT : CAOUTCHOUC SYNTHETIQUE SPECIAL, RESISTANT AUX HUILES, A L'ABRASION, A L'OZONE ET AUX AGENTS ATMOSPHERIQUES.
 APPLICATION : POUR REFOULEMENT D'HYDROCARBURES A TENEUR EN AROMATIQUES JUSQU'A 50%

ID		OD		WP		BP		BR/r	W	L
inch	mm	mm	mm	bar	psi	bar	psi	mm	g/m	m
3/4"	19	31	31	16	232	48	696	125	625	40-46-61
1"	25.4	37	37	16	232	48	696	150	730	40-46-61
1 1/4"	32	44	44	16	232	48	696	175	935	40-46-61
1 1/2"	38	51	51	16	232	48	696	225	1192	40-46-61
2"	50.8	67	67	16	232	48	696	275	1960	40-46-61
2 1/2"	63.5	79	79	16	232	48	696	300	2237	40-46-61
3"	76.2	92	92	16	232	48	696	350	2727	40-46-61
4"	101.6	118	118	16	232	48	696	450	3710	40-46-61
5"	127	145	145	16	232	48	696	635	4815	40-46-61
6"	152.4	172	172	16	232	48	696	750	6135	40-46-61

OPTIONS / OPTIONEN / OPZIONI / OPTIONS

Tube upon request : Conductive (Ω)
 Seele nach Anfrage : Leitfähig (Ω)
 Sottostrato su richiesta : Conduttiva (Ω)
 Tube sur demande : Conducteur (Ω)



-30°C / + 70°C
 -22°F / +158°F



MARKING / BESCHRIFTUNG / MARCATURA / MARQUAGE: **TRANSFER TAPE OR EMBOSSED**

SEL FOSSIL D/16 OIL DISCHARGE HOSE - TS 9464 EN 1761: 2002 - Type D - M - W.P. 16 BAR (232 PSI)

NORMS NORMEN NORME NORMES	TS 9464 EN 1761 TYPE D ISO 1307	COLOUR FARBEN COLORI COULEUR	
------------------------------------	------------------------------------	---------------------------------------	--

Oil S&D 16 BAR



EN 1761 Type SD



TUBE : OIL AND PETROL RESISTANT BLACK NBR.
 REINFORCEMENT : HIGH TENSILE SYNTHETIC TEXTILE, 2 STEEL WIRE HELIX AND 2 ANTISTATIC COPPER WIRE.
 COVER : ABRASION, OZONE, WEATHER, FLAME, HEAT, GASOLINE, OIL AND SEAWATER RESISTANT SPECIAL SYNTHETIC RUBBER.
 APPLICATION : FOR SUCTION AND DISCHARGE OF PETROLEUM PRODUCTS WITH AROMATIC CONTENT UP TO %50.



SEELE : ÖL-UND KRAFTSTOFFBESTÄNDIG, NITRILGUMMI, SCHWARZ.
 EINLAGE : HOCHZUGSFESTE SYNTHETISCHE TEXTILEINLAGE, 2 STAHLDRAHTSPIRALEN UND 2 ANTISTATISCHE KUPFERLITZEN.
 DECKE : ABRIEBFESTER, HITZE-, ÖL-, OZON- UND WITTERUNGBESTÄNDIGER, FLAMMWIDRIGER, SPEZIELLER SYNTHETIKGUMMI, BESTÄNDIG GEGEN KRAFTSTOFFE UND SALZWASSER.
 ANWENDUNG : SAUG UND DRUCKSCHLAUCH FÜR VERSCHIEDENE ÖLPRODUKTE MIT MAX. 50% AROMATENGHALT



SOTTOSTRATO : GOMMA NBR NERA, RESISTENTE AI PRODOTTI PETROLIFERI.
 RINFORZO : INSERZIONI TESSILI AD ALTA TENACITÀ CON 2 SPIRALI D'ACCIAIO E 2 CORDICELLE DI RAME ANTISTATICHE.
 COPERTURA : GOMMA SPECIALE NERA, RESISTENTE AGLI OLI, ALL'OZONO, ALL'ABRASIONE, AGLI AGENTI ATMOSFERICI ED ALL'ACQUA DI MARE.
 IMPIEGO : PER ASPIRAZIONE E MANDATA DI PRODOTTI PETROLIFERI CON CONTENUTO AROMATICO FINO AL 50%.



TUBE : CAOUTCHOUC NBR, NOIR, RESISTANT AUX HUILES ET AUX HYDROCARBURES.
 REINFORCEMENT : INSERTION TEXTILE HAUTE TENACITE, 2 SPIRALES EN ACIER ET 2 FILS DE MASSE ANTISTATIQUES.
 REVETEMENT : CAOUTCHOUC SYNTHETIQUE SPECIAL, RESISTANT AUX HUILES, A L'ABRASION, A L'OZONE, AUX AGENTS ATMOSPHERIQUES ET A L'EAU DE MER.
 APPLICATION : POUR ASPIRATION ET REFOULEMENT D'HYDROCARBURES A TENEUR EN AROMATIQUES JUSQU'A 50%.

ID		OD		WP		BP		VACUUM	BR/r	W	L
inch	mm	mm	bar	psi	bar	psi	bar	mm	g/m	m	
3/4"	19	31	16	232	48	696	-0.80	125	672	40-46-61	
1"	25.4	37	16	232	48	696	-0.80	150	810	40-46-61	
1 1/4"	32	44	16	232	48	696	-0.80	175	1035	40-46-61	
1 1/2"	38	51	16	232	48	696	-0.80	225	1375	40-46-61	
2"	50.8	67	16	232	48	696	-0.80	275	2215	40-46-61	
2 1/2"	63.5	79	16	232	48	696	-0.80	300	2625	40-46-61	
3"	76.2	92	16	232	48	696	-0.80	350	3375	40-46-61	
4"	101.6	118	16	232	48	696	-0.80	450	4415	40-46-61	
5"	127	145	16	232	48	696	-0.80	635	5800	40-46-61	
6"	152.4	172	16	232	48	696	-0.80	750	8145	40-46-61	

OPTIONS / OPTIONEN / OPZIONI / OPTIONS

Tube upon request : Conductive (Ω)
 Seele nach Anfrage : Leitfähig (Ω)
 Sottostrato su richiesta : Conduttiva (Ω)
 Tube sur demande : Conducteur (Ω)



-30°C / + 70°C
 -22°F / +158°F



MARKING / BESCHRIFTUNG / MARCATURA / MARQUAGE: **TRANSFER TAPE OR EMBOSSED**

SEL **FOSSIL SD/16** OIL S / D HOSE - TS 9464 EN 1761: 2002 - Type SD - M - W.P. 16 BAR (232 PSI)

NORMS NORMEN NORME NORMES	TS 9464 EN 1761 TYPE SD ISO 1307	COLOUR FARBEN COLORI COULEUR	
------------------------------------	-------------------------------------	---------------------------------------	--



Oil Discharge 16 Bar



EN 12115 Type D



TUBE : OIL AND PETROL RESISTANT CONDUCTIVE NBR.
 REINFORCEMENT : HIGH TENSILE SYNTHETIC TEXTILE AND 2 ANTISTATIC COPPER WIRE.
 COVER : OIL, WEATHER, FLAME, OZONE, ABRASION AND SEA WATER RESISTANT , SPECIAL SYNTHETIC RUBBER.
 APPLICATION : FOR DELIVERY OF PETROLEUM PRODUCTS WITH AROMATIC CONTENT UP TO 50%.



SEELE : ÖL-UND KRAFTSTOFFBESTÄNDIG, NITRILGUMMI, SCHWARZ.
 EINLAGE : HOCHZUGFESTE SYNTHETISCHE TEXTILEINLAGE MIT 2 ANTISTATISCHE KUPFERLITZEN.
 DECKE : ÖL-, OZON-, UND WITTERUNGSBESTÄNDIGER, FLAMMWIDRIGER, SPEZIELER SYNTHETIKGUMMI, BESTÄNDIG GEGEN MEERWASSER.
 ANWENDUNG : FÖRDERSCHLAUCH FÜR MINERALÖLPRODUKTE MIT MAX. %50 AROMATENGEHALT.



SOTTOSTRATO : GOMMA NBR NERA CONDUTTIVA, RESISTENTE AI PRODOTTI PETROLIFERI.
 RINFORZO : INSERZIONE TESSILI AD ALTA TENACITÀ CON 2 CORDICELLE DI RAME ANTISTATICHE.
 COPERTURA : GOMMA SPECIALE SINTETICA, RESISTENTE AGLI OLI, ALLA FIAMMA, ALL'OZONO, ALL' ABRASIONE ET AGLI AGENTI ATMOSFERICI ED ALL'ACQUA DI MARE.
 IMPIEGO : PER MANDATA DI PRODOTTI PETROLIFERI CON CONTENUTO AROMATICO FINO AL 50%.



TUBE : CAOUTCHOUC NBR, CONDUCTEUR, RESISTANT AUX HUILES ET AUX HYDROCARBURES.
 RENFORCEMENT : INSERTION TEXTILE HAUTE TENACITE ET 2 FILS DE MASSE ANTISTATIQUES..
 REVETEMENT : CAOUTCHOUC SYNTHETIQUE SPECIAL, RESISTANT AUX HUILES, A L'ABRASION, A L'OZONE, A LA FLAMME, A L'EAU DE MER ET AUX AGENTS ATMOSPHERIQUES.
 APPLICATION : POUR REFOULEMENT D'HYDROCARBURES A TENEUR EN AROMATIQUES JUSQU'A 50%.

ID		OD		WP		BP		BR/r	W	L
inch	mm	mm	mm	bar	psi	bar	psi	mm	g/m	m
3/4"	19	31	31	16	232	64	928	125	632	40-46-61
1"	25.4	37	37	16	232	64	928	150	777	40-46-61
1 1/4"	32	44	44	16	232	64	928	175	974	40-46-61
1 1/2"	38	51	51	16	232	64	928	225	1219	40-46-61
2"	50.8	67	67	16	232	64	928	275	2007	40-46-61
2 1/2"	63.5	79	79	16	232	64	928	300	2308	40-46-61
3"	76.2	92	92	16	232	64	928	350	2783	40-46-61
4"	101.6	118	118	16	232	64	928	450	3823	40-46-61



-20°C / + 70°C
 - 4°F / +158°F



MARKING / BESCHRIFTUNG / MARCATURA / MARQUAGE: **TRANSFER TAPE OR EMBOSSED**

SEL YAKIT-EN 12115/D-16 OIL DISCHARGE HOSE - TS EN 12115 - NBR - Type D - M - W.P. 16 BAR (232 PSI)

NORMS NORMEN NORME NORMES	EN 12115 TYPE D ISO 1307	COLOUR FARBEN COLORI COULEUR	
------------------------------------	-----------------------------	---------------------------------------	--

Oil S&D 16 BAR



EN 12115 Type SD



TUBE : OIL AND PETROL RESISTANT CONDUCTIVE NBR.
 REINFORCEMENT : HIGH TENSILE SYNTHETIC TEXTILE, STEEL WIRE HELIX AND 2 ANTISTATIC COPPER WIRE.
 COVER : OIL, WEATHER, FLAME, OZONE, ABRASION AND SEA WATER RESISTANT, SPECIAL SYNTHETIC RUBBER.
 APPLICATION : FOR SUCTION AND DISCHARGE OF PETROLEUM PRODUCTS WITH AROMATIC CONTENT UP TO 50%.



SEELE : ÖL-UND KRAFTSTOFFBESTÄNDIG, NITRILGUMMI, SCHWARZ.
 EINLAGE : HOCHZUGFESTE SYNTHETISCHE TEXTILEINLAGE MIT 2 ANTISTATISCHE KUPFERLITZEN.
 DECKE : ÖL-, OZON-, UND WITTERUNGSBESTÄNDIGER, FLAMMWIDRIGER, SPEZIELER SYNTHETIKGUMMI, BESTÄNDIG GEGEN MEERWASSER.
 ANWENDUNG : SAUG UND DRUCKSCHLAUCH FÜR MINERALÖLPRODUKTE MIT MAX. %50 AROMATENGEGHALT.



SOTTOSTRATO : GOMMA NBR NERA CONDUTTIVA, RESISTENTE AI PRODOTTI PETROLIFERI.
 RINFORZO : INSERZIONE TESSILI AD ALTA TENACITÀ CON SPIRALE D'ACCIAIO E 2 CORDICELLE DI RAME ANTISTATICHE.
 COPERTURA : GOMMA SPECIALE SINTETICA, RESISTENTE AGLI OLII, ALLA FIAMMA, ALL'OZONO, ALL' ABRASIONE, AGLI AGENTI ATMOSFERICI ED ALL'ACQUA DIMARE.
 IMPIEGO : PER ASPIRAZIONE E MANDATA DI PRODOTTI PETROLIFERI CON CONTENUTO AROMATICO FINO AL 50%.



TUBE : CAOUTCHOUC NBR, CONDUCTEUR, RESISTANT AUX HUILES ET AUX HYDROCARBURES.
 RENFORCEMENT : INSERTION TEXTILE HAUTE TENACITE, SPIRALE EN ACIER ET 2 FILS DE MASSE ANTISTATIQUES.
 REVETEMENT : CAOUTCHOUC SYNTHETIQUE SPECIAL, RESISTANT AUX HUILES, A L'ABRASION, A L'OZONE, A LA FLAMME, A L'EAU DE MER ET AUX AGENTS ATMOSPHERIQUES.
 APPLICATION : POUR ASPIRATION ET REFOULEMENT D'HYDROCARBURES A TENEUR EN AROMATIQUES JUSQU'A 50%

ID		OD		WP		BP		VACUUM	BR/r	W	L
inch	mm	mm	bar	psi	bar	psi	bar	mm	g/m	m	
3/4"	19	31	16	232	64	928	-0.92	125	673	40-46-61	
1"	25.4	37	16	232	64	928	-0.92	150	842	40-46-61	
1 1/4"	32	44	16	232	64	928	-0.92	175	1037	40-46-61	
1 1/2"	38	51	16	232	64	928	-0.92	225	1408	40-46-61	
2"	50.8	67	16	232	64	928	-0.92	275	2205	40-46-61	
2 1/2"	63.5	79	16	232	64	928	-0.92	300	2739	40-46-61	
3"	76.2	92	16	232	64	928	-0.80	350	3304	40-46-61	
4"	101.6	118	16	232	64	928	-0.80	450	4542	40-46-61	



-20°C / + 70°C
 - 4°F / +158°F



MARKING / BESCHRIFTUNG / MARCATURA / MARQUAGE: **TRANSFER TAPE OR EMBOSSED**

SEL YAKIT-EN 12115/SD-16 OIL S/D DISCHARGE HOSE - TS EN 12115 - NBR - Type SD - M - W.P. 16 BAR (232 PSI)

NORMS NORMEN NORME NORMES	EN 12115 TYPE SD	COLOUR FARBEN COLORI COULEUR	
------------------------------------	------------------	---------------------------------------	--



Textile Hydraulic R4



TUBE : HYDRAULIC OIL RESISTANT SPECIAL NBR RUBBER.
 REINFORCEMENT : HIGH TENSILE SYNTHETIC TEXTILE AND STEEL WIRE HELIX.
 COVER : OIL, HEAT, ABRASION, OZONE AND WEATHER RESISTANT SPECIAL CR RUBBER.
 APPLICATION : IN OIL RETURN LINES OF HYDRAULIC SYSTEMS OF INDUSTRIAL AND AGRICULTURAL APPLICATIONS.



SEELE : SPEZIELLES NBR GUMMI, BESTÄNDIG GEGEN HYDRAULIKÖLE.
 EINLAGE : HOCHZUGFESTE, SYNTHETISCHE TEXTILEINLAGE MIT ZUSÄTZLICHER STAHLDRAHTSPIRALE.
 DECKE : SPEZIELLES CR GUMMI, ÖL-, ABRIE- UND WITTERUNGSBESTÄNDIG.
 ANWENDUNG : GEEIGNET ALS S/D SCHLAUCH FÜR MINERALÖLE IN DER INDUSTRIE UND ALS ÖLRÜCKLAUFSCHLAUCH FÜR LANDWIRTSCHAFTSMASCHINEN.



SOTTOSTRATO : GOMMA IN NBR, RESISTENTE AGLI OLI IDRAULICI.
 RINFORZO : INSERZIONI TESSILI AD ALTA TENACITÀ CON SPIRALE D'ACCIAIO.
 COPERTURA : GOMMA SPECIALE IN CR, RESISTENTE AGLI OLI, ALL'OZONO, ALL'ABRASIONE ED AGLI AGENTI ATMOSFERICI.
 IMPIEGO : MANDATA ED ASPIRAZIONE DI FLUIDI IDRAULICI A BASE DI OLI MINERALI PER CIRCUITI OLEODINAMICI.



TUBE : CAOUTCHOUC SPECIAL NBR RESISTANT AUX HUILES HYDRAULIQUES.
 RENFORCEMENT : INSERTION TEXTILE HAUTE TENACITE, SPIRALE EN ACIER NOYEE.
 REVETEMENT : CAOUTCHOUC SPECIAL EN CR RESISTANT A L'OZONE, AUX HUILES, CARBURANTS ET AGENTS ATMOSPHERIQUES.
 APPLICATION : POUR ASPIRATION ET REFOULEMENT D'HUILE DANS LES SYSTEMES HYDRAULIQUES.

Dash Size	ID		OD	WP		BP		VACUUM	BR/r	W	L
	inch	mm	mm	bar	psi	bar	psi	bar	mm	g/m	m
-12	3/4"	19	32	21	305	84	1218	-0.80	125	755	40-46-61
-16	1"	25.4	37.4	17	247	68	986	-0.80	150	885	40-46-61
-20	1 1/4"	31.8	45	14	203	56	812	-0.80	200	1140	40-46-61
-24	1 1/2"	38.1	52	10	145	40	580	-0.80	255	1550	40-46-61
-28	1 3/4"	44.5	58	10	145	40	580	-0.80	270	1775	40-46-61
-32	2"	50.8	64	7	102	28	406	-0.80	300	1890	40-46-61
-40	2 1/2"	63.5	77	4	58	16	232	-0.80	355	2377	40-46-61
-48	3"	76.2	90	4	58	16	232	-0.80	460	3121	40-46-61
-56	3 1/2"	88.9	103	3	44	12	174	-0.80	530	3416	40-46-61
-64	4"	101.6	116	2	29	8	116	-0.80	610	4171	40-46-61

OPTIONS / OPTIONEN / OPZIONI / OPTIONS

Tube upon request : Conductive (Ω)
 Seele nach Anfrage : Leitfähig (Ω)
 Sottostrato su richiesta : Conduttiva (Ω)
 Tube sur demande : Conducteur (Ω)

Upon request :
 Auf Anfrage :
 Su richiesta :
 Sur demande :



-40°C / +100°C
 -40°F / +212°F

MARKING / BESCHRIFTUNG / MARCATURA / MARQUAGE: **TRANSFER TAPE OR EMBOSSED**



NORMS NORMEN NORME NORMES	SAE J 517 ISO 1307	COLOUR FARBEN COLORI COULEUR	
------------------------------------	-----------------------	---------------------------------------	--

Hydraulic Oil S/D Economic



TUBE : HYDRAULIC OIL RESISTANT SPECIAL SYNTHETIC RUBBER.
 REINFORCEMENT : HIGH TENSILE SYNTHETIC TEXTILE AND STEEL WIRE HELIX.
 COVER : OIL,HEAT,ABRASION,OZON AND WEATHER RESISTANT SPECIAL SYNTHETIC RUBBER.
 APPLICATION : IN OIL RETURN LINES OF HYDRAULIC SYSTEMS OF INDUSTRIAL AND AGRICULTURAL APPLICATIONS.



SEELE : SPEZIELLES SYNTHETISCHES GUMMI, BESTÄNDIG GEGEN HYDRAULIKÖLE.
 EINLAGE : HOCHZUGFESTE, SYNTHETISCHE TEXTILEINLAGE MIT ZUSÄTZLICHER STAHLDRAHTSPIRALE.
 DECKE : SPEZIELLES SYNTHETISCHES GUMMI, ÖL-, OZON- UND WITTERUNGSBESTÄNDIG.
 ANWENDUNG : GEEIGNET ALS S/D SCHLAUCH FÜR MINERALÖLE IN DER INDUSTRIE UND ALS ÖLRÜCKLAUFSCHLAUCH FÜR LANDWIRTSCHAFTSMASCHINEN.



SOTTOSTRATO : GOMMA NERA ,RESISTENTE AGLI OLI IDRAULICI.
 RINFORZO : INSERZIONI TESSILI AD ALTA TENACITÀ CON SPIRALE D'ACCIAIO.
 COPERTURA : GOMMA SPECIALE SINTETICA ,RESISTENTE AGLI OLI, ALL'OZONO, ALL'ABRASIONE ED AGLI AGENTI ATMOSFERICI.
 IMPIEGO : MANDATA ED ASPIRAZIONE DI FLUIDI IDRAULICI A BASE DI OLI MINERALI PER CIRCUITI OLEODINAMICI.



TUBE : CAOUTCHOUC SPECIAL SYNTHETIQUE RESISTANT AUX HUILES HYDRAULIQUES.
 RENFORCEMENT : INSERTION TEXTILE HAUTE TENACITE, SPIRALE EN ACIER NOYEE
 REVETEMENT : CAOUTCHOUC SPECIAL SYNTHETIQUE RESISTANT A L'OZONE, AUX HUILES, CARBURANTS ET AGENTS ATMOSPHERIQUES.
 APPLICATION : POUR ASPIRATION ET REFOULEMENT D'HUILE DANS LES SYSTEMES HYDRAULIQUES.

Dash Size	ID		OD	WP		BP		VACUUM	BR/r	W	L
	inch	mm	mm	bar	psi	bar	psi	bar	mm	g/m	m
-12	3/4"	19	29	21	305	84	1218	-0.80	100	530	40-46-61
-16	1"	25.4	35	17	247	68	986	-0.80	125	665	40-46-61
-20	1 1/4"	31.8	42	14	203	56	812	-0.80	150	825	40-46-61
-24	1 1/2"	38.1	49	10	145	40	580	-0.80	200	1235	40-46-61
-28	1 3/4"	44.5	56	10	145	40	580	-0.80	225	1480	40-46-61
-32	2"	50.8	62	7	102	28	406	-0.80	250	1570	40-46-61
-40	2 1/2"	63.5	75.5	4	58	16	232	-0.80	350	2105	40-46-61
-48	3"	76.2	88	4	58	16	232	-0.80	400	2695	40-46-61
-56	3 1/2"	88.9	103	3	44	12	174	-0.80	450	3400	40-46-61
-64	4"	101.6	115	2	29	8	116	-0.80	550	3900	40-46-61

OPTIONS / OPTIONEN / OPZIONI / OPTIONS

Tube upon request : Conductive (Ω)
 Seele nach Anfrage : Leitfähig (Ω)
 Sottostrato su richiesta : Conduttiva (Ω)
 Tube sur demande : Conducteur (Ω)



-30°C / + 70°C
 -22°F / +158°F

MARKING / BESCHRIFTUNG / MARCATURA / MARQUAGE: **TRANSFER TAPE OR EMBOSSED**



NORMS NORMEN NORME NORMES	ISO 1307	COLOUR FARBEN COLORI COULEUR	
------------------------------------	----------	---------------------------------------	--



Textile Hydraulic R4-X



X-Flexibility



TUBE : HYDRAULIC OIL RESISTANT SPECIAL NBR RUBBER.
 REINFORCEMENT : HIGH TENSILE SYNTHETIC TEXTILE AND STEEL WIRE HELIX.
 COVER : OIL, HEAT, ABRASION, OZONE AND WEATHER RESISTANT SPECIAL CR RUBBER.
 APPLICATION : IN OIL RETURN LINES OF HYDRAULIC SYSTEMS OF INDUSTRIAL AND AGRICULTURAL APPLICATIONS.



SEELE : SPEZIELLES NBR GUMMI, BESTÄNDIG GEGEN HYDRAULIKÖLE.
 EINLAGE : HOCHZUGFESTE, SYNTHETISCHE TEXTILEINLAGE MIT ZUSÄTZLICHER STAHLDRAHTSPIRALE.
 DECKE : SPEZIELLES CR GUMMI, ÖL-, OZON- UND WITTERUNGSBESTÄNDIG.
 ANWENDUNG : GEEIGNET ALS S/D SCHLAUCH FÜR MINERALÖLE IN DER INDUSTRIE UND ALS ÖLRÜCKLAUFSCHLAUCH FÜR LANDWIRTSCHAFTSMASCHINEN.



SOTTOSTRATO : GOMMA IN NBR, RESISTENTE AGLI OLI IDRAULICI.
 RINFORZO : INSERZIONI TESSILI AD ALTA TENACITÀ CON SPIRALE D'ACCIAIO.
 COPERTURA : GOMMA SPECIALE IN CR, RESISTENTE AGLI OLI, ALL'OZONO, ALL'ABRASIONE ED AGLI AGENTI ATMOSFERICI.
 IMPIEGO : MANDATA ED ASPIRAZIONE DI FLUIDI IDRAULICI A BASE DI OLI MINERALI PER CIRCUITI OLEODINAMICI.



TUBE : CAOUTCHOUC SPECIAL NBR RESISTANT AUX HUILES HYDRAULIQUES.
 REINFORCEMENT : INSERTION TEXTILE HAUTE TENACITE, SPIRALE EN ACIER NOYEE.
 REVETEMENT : CAOUTCHOUC SPECIAL EN CR RESISTANT A L'OZONE, AUX HUILES, CARBURANTS ET AGENTS ATMOSPERIQUES.
 APPLICATION : POUR ASPIRATION ET REFOULEMENT D'HUILE DANS LES SYSTEMES HYDRAULIQUES.

Dash Size	ID		OD	WP		BP		VACUUM	BR/r	W	L
	inch	mm	mm	bar	psi	bar	psi	bar	mm	g/m	m
-12	3/4"	19	29	21	305	84	1218	-0.80	50	522	40-46-61
-16	1"	25.4	35	17	247	68	986	-0.80	65	638	40-46-61
-20	1 1/4"	31.8	42	14	203	56	812	-0.80	85	825	40-46-61
-24	1 1/2"	38.1	49	10	145	40	580	-0.80	95	1075	40-46-61
-28	1 3/4"	44.5	56	10	145	40	580	-0.80	110	1396	40-46-61
-32	2"	50.8	62	7	102	28	406	-0.80	135	1544	40-46-61
-40	2 1/2"	63.5	75.5	4	58	16	232	-0.80	180	2018	40-46-61
-48	3"	76.2	88	4	58	16	232	-0.80	225	2505	40-46-61
-56	3 1/2"	88.9	103	3	44	12	174	-0.80	270	3162	40-46-61
-64	4"	101.6	115	2	29	8	116	-0.80	390	3635	40-46-61

OPTIONS / OPTIONEN / OPZIONI / OPTIONS

- Tube upon request : Conductive (Ω)
- Seele nach Anfrage : Leitfähig (Ω)
- Sottostrato su richiesta : Conduttiva (Ω)
- Tube sur demande : Conducteur (Ω)



-40°C / +100°C
 -40°F / +212°F

MARKING / BESCHRIFTUNG / MARCATURA / MARQUAGE: **TRANSFER TAPE OR EMBOSSED**



NORMS	SAE J 517	COLOUR FARBEN COLORI COULEUR	
NORMEN	ISO 1307		
NORME			
NORMES			

Textile Hydraulic R4 - High Temp.

+135 °C



TUBE : HIGH TEMPERATURE HYDRAULIC OIL RESISTANT SPECIAL SYNTHETIC RUBBER.
 REINFORCEMENT : HIGH TENSILE SYNTHETIC TEXTILE AND STEEL WIRE HELIX.
 COVER : OIL, HEAT, ABRASION, OZONE AND WEATHER RESISTANT SPECIAL SYNTHETIC RUBBER.
 APPLICATION : IN OIL RETURN LINES OF HYDRAULIC SYSTEMS OF INDUSTRIAL AND AGRICULTURAL APPLICATIONS, WHERE OPERATING TEMPERATURES ARE UP TO 150 °C.



SEELE : SPEZIELLES SYNTETHISCHES GUMMI, BESTÄNDIG GEGEN HYDRAULIKÖLE MIT HOHEN ANWENDUNGSTEMPERATUREN.
 EINLAGE : HOCHZUGFESTE, SYNTHETISCHE TEXTILEINLAGEN MIT ZUSÄTZLICHER STAHLDRAHTSPIRALE.
 DECKE : SPEZIELLES SYNTETHISCHES GUMMI, ÖL-, ABRIEB- UND WITTERUNGSBESTÄNDIG.
 ANWENDUNG : GEEIGNET ALS S/D SCHLAUCH FÜR MINERALÖLE IN DER INDUSTRIE UND ALS ÖLRÜCKLAUFSCHAUCH FÜR LANDWIRTSCHAFTSMASCHINEN. EINSATZFÄHIG BIS ZU 150 °C BETRIEBSTEMPERATUR.



SOTTOSTRATO : GOMMA SPECIALE SINTETICA, RESISTENTE AGLI OLI IDRAULICI AD ALTA TEMPERATURA..
 RINFORZO : INSERZIONI TESSILI AD ALTA TENACITÀ CON SPIRALE METALLICA.
 COPERTURA : GOMMA SPECIALE SINTETICA, RESISTENTE AGLI OLI, ALL'OZONO, ALL'ABRASIONE ED AGLI AGENTI ATMOSFERICI.
 IMPIEGO : MANDATA ED ASPIRAZIONE DEI FLUIDI IDRAULICI A BASE DEGLI OLI MINERALI PER CIRCUITI OLEODINAMICI, AD ALTA TEMPERATURA FINO A 150 °C.



TUBE : CAOUTCHOUC SPECIAL SYNTHETIQUE RESISTANT AUX HUILES HYDRAULIQUES HAUTE TEMPERATURE.
 RENFORCEMENT : INSERTION TEXTILE HAUTE TENACITE, SPIRALE EN ACIER NOYEE.
 REVETEMENT : CAOUTCHOUC SPECIAL SYNTHETIQUE RESISTANTE A L'OZONE, AUX HUILES, CARBURANTS ET AGENTS ATMOSPHERIQUES.
 APPLICATION : POUR ASPIRATION ET REFOULEMENT D'HUILE DANS LES SYSTEMES HYDRAULIQUES POUVANT ATTEINDRE 150 °C EN POINTE.

Dash Size	ID		OD		WP		BP		VACUUM	BR/r	W	L
	inch	mm	mm	mm	bar	psi	bar	psi	bar	mm	g/m	m
-12	3/4"	19	32	21	305	84	1218	-0.80	125	767	40-46-61	
-16	1"	25.4	37.4	17	247	68	986	-0.80	150	898	40-46-61	
-20	1 1/4"	31.8	45	14	203	56	812	-0.80	200	1179	40-46-61	
-24	1 1/2"	38.1	52	10	145	40	580	-0.80	255	1525	40-46-61	
-28	1 3/4"	44.5	58	10	140	40	580	-0.80	270	1745	40-46-61	
-32	2"	50.8	64	7	102	28	406	-0.80	300	1926	40-46-61	
-40	2 1/2"	63.5	77	4	58	16	232	-0.80	355	2433	40-46-61	
-48	3"	76.2	90	4	58	16	232	-0.80	460	2980	40-46-61	
-56	3 1/2"	88.9	103	3	44	12	174	-0.80	530	3244	40-46-61	
-64	4"	101.6	116	2	29	8	116	-0.80	610	3983	40-46-61	



-40 °C / +135 °C
 -40 °F / +275 °F

(+150 °C DISCONTINUOUS)
 (+302 °F DISCONTINUOUS)

MARKING / BESCHRIFTUNG / MARCATURA / MARQUAGE: **TRANSFER TAPE OR EMBOSSED**

SEL **ULTIMATE R4** SAE J 517 - WP *** Bar / **** PSI ** mm

NORMS NORMEN NORME NORMES	SAE J 517 ISO 1307	COLOUR FARBEN COLORI COULEUR	
------------------------------------	-----------------------	---------------------------------------	--

Dock Oil

EN 1765 Type S



TUBE : OIL AND PETROL RESISTANT NBR RUBBER.
 REINFORCEMENT : HIGH TENSILE SYNTHETIC TEXTILE, 2 STEEL WIRE HELIX AND ANTISTATIC COPPER WIRE.
 COVER : OIL, WEATHER, OZONE, ABRASION AND SEA WATER RESISTANT, SPECIAL SYNTHETIC RUBBER.
 APPLICATION : FOR SUCTION AND DISCHARGE OF PETROLEUM PRODUCTS WITH AROMATIC CONTENT UP TO 50% FROM TANKERS AND BARGES BUNKERING SERVICES AND INDUSTRIAL APPLICATIONS.



SEELE : ÖL-UND KRAFTSTOFFBESTÄNDIGER NBR-GUMMI.
 EINLAGE : HOCHZUGFESTE SYNTHETISCHE TEXTILEINLAGE, 2 STAHLDRAHTSPIRALEN UND ANTISTATISCHER KUPFERLITZE.
 DECKE : ABRIEFEST, ÖL-, MEERWASSER-, UND WITTERUNGSBESTÄNDIG, SPEZIELER SYNTHETIKGUMMI.
 ANWENDUNG : SAUG UND DRUCKSCHLAUCH FÜR TANKER, BETANKUNGSFAHRZEUGE UND SCHIFFE MIT BENZIN, DIESEL, HEIZÖL UND MINERALÖLE MIT 50% AROMATENGEHALT.



SOTTOSTRATO : GOMMA NBR, RESISTENTE AI PRODOTTI PETROLIFERI.
 RINFORZO : INSERZIONI TESSILI AD ALTA TENACITÀ CON 2 SPIRALI D'ACCIAIO E CORDICELLA DI RAME ANTISTATICA.
 COPERTURA : GOMMA SPECIALE SINTETICA NERA, RESISTENTE AGLI OLI, ALL'OZONO, ALL'ABRASIONE, AGLI AGENTI ATMOSFERICI ED ALL'ACQUA DI MARE.
 IMPIEGO : ASPIRAZIONE E MANDATA DI PRODOTTI PETROLIFERI CON CONTENUTO AROMATICO FINO AL 50% NEL BUNKERAGGIO ED ALTRE APPLICAZIONI INDUSTRIALI.



TUBE : CAOUTCHOUC NBR, RESISTANT AUX HUILES ET HYDROCARBURES.
 RENFORCEMENT : INSERTION TEXTILE HAUTE TENACITE, 2 SPIRALES EN ACIER ET FIL DE MASSE ANTISTATIQUE.
 REVETEMENT : CAOUTCHOUC SYNTHETIQUE SPECIAL, RESISTANT A L'ABRASION, A L'OZONE, AUX HUILES, A L'EAU DE MER ET AUX AGENTS ATMOSPHERIQUES.
 APPLICATION : POUR ASPIRATION ET REFOULEMENT DES PRODUITS PETROLIERS AVEC TENEUR EN AROMATIQUES JUSQU'A 50% ENTRE LES NAVIRES PETROLIERS OU LES BARGES VERS LES SITES INDUSTRIELS.



DOH 459 - Dock Oil Hose EN 1765: Type S10

inch	mm	mm	bar	psi	bar	psi	bar	mm	g/m	m
4"	101.6	128	10	145	40	580	-0.92	500	6820	40-46-61
5"	127	156	10	145	40	580	-0.92	650	9395	40-46-61
6"	152.4	185	10	145	40	580	-0.92	750	13150	40-46-61
8"	203	239	10	145	40	580	-0.92	950	18490	20
10"	254	293	10	145	40	580	-0.92	1200	25520	10

DOH 460 - Dock Oil Hose EN 1765: Type S15

inch	mm	mm	bar	psi	bar	psi	bar	mm	g/m	m
4"	101.6	130	15	217.5	60	870	-0.92	500	6980	40-46-61
5"	127	158	15	217.5	60	870	-0.92	650	9650	40-46-61
6"	152.4	188	15	217.5	60	870	-0.92	750	14385	40-46-61
8"	203	242	15	217.5	60	870	-0.92	950	20170	20
10"	254	296	15	217.5	60	870	-0.92	1200	27490	10



-30°C /+ 82°C
 -50°F /+ 180°F

AROMATIC CONTENT: ≤ % 50



MARKING / BESCHRIFTUNG / MARCATURA / MARQUAGE: **TRANSFER TAPE OR EMBOSSED**



NORMS NORMEN NORME NORMES	TS-EN 1765 TYPE S10 TS-EN 1765 TYPE S15 ISO 1307	COLOUR FARBEN COLORI COULEUR	
------------------------------------	--	---------------------------------------	--

Swaged Flanges Petroleum S&D Hose For Tankers & Bunkering

EN 1765 Type S10



TUBE : OIL AND PETROL RESISTANT NBR RUBBER.
 REINFORCEMENT : HIGH TENSILE SYNTHETIC TEXTILE, 2 STEEL WIRE HELIX AND ANTISTATIC COPPER WIRE.
 COVER : OIL, WEATHER, OZONE, ABRASION AND SEA WATER RESISTANT, SPECIAL SYNTHETIC RUBBER.
 APPLICATION : FOR SUCTION AND DISCHARGE OF PETROLEUM PRODUCTS WITH AROMATIC CONTENT UP TO 50% FROM TANKERS AND BARGES BUNKERING SERVICES AND INDUSTRIAL APPLICATIONS.



SEELE : ÖL-UND KRAFTSTOFFBESTÄNDIGER NBR-GUMMI
 EINLAGE : HOCHZUGFESTE SYNTHETISCHE TEXTILEINLAGE, 2 STAHLDRAHTSPIRALEN UND ANTISTATISCHER KUPFERLITZE
 DECKE : ABRIEBFEST, ÖL-, MEERWASSER-, UND WITTERUNGSBESTÄNDIG, SPEZIELER SYNTHETIKGUMMI
 ANWENDUNG : SAUG UND DRUCKSCHLAUCH FÜR TANKER, BETANKUNGSFAHRZEUGE UND SCHIFFE MIT BENZIN, DIESEL, HEIZÖL UND MINERALÖLE MIT 50% AROMATENGEGHALT, EINGEPRESST



SOTTOSTRATO : GOMMA NBR, RESISTENTE AI PRODOTTI PETROLIFERI.
 RINFORZO : INSERZIONI TESSILI AD ALTA TENACITÀ CON 2 SPIRALI D'ACCIAIO E CORDICELLA DI RAME ANTISTATICA.
 COPERTURA : GOMMA SPECIALE SINTETICA NERA, RESISTENTE AGLI OLI, ALL'OZONO, ALL'ABRASIONE, AGLI AGENTI ATMOSFERICI ED ALL'ACQUA DI MARE.
 IMPIEGO : ASPIRAZIONE E MANDATA DI PRODOTTI PETROLIFERI CON CONTENUTO AROMATICO FINO AL 50% NEL BUNKERAGGIO ED ALTRE APPLICAZIONI INDUSTRIALI.



TUBE : CAOUTCHOUC NBR, RESISTANT AUX HUILES ET HYDROCARBURES.
 RENFORCEMENT : INSERTION TEXTILE HAUTE TENACITE, 2 SPIRALES EN ACIER ET FIL DE MASSE ANTISTATIQUE.
 REVETEMENT : CAOUTCHOUC SYNTHETIQUE SPECIAL, RESISTANT A L'ABRASION, A L'OZONE, AUX HUILES, A L'EAU DE MER ET AUX AGENTS ATMOSPHERIQUES.
 APPLICATION : POUR ASPIRATION ET REFOULEMENT DES PRODUITS PETROLIERS AVEC TENEUR EN AROMATIQUES JUSQU'A 50% ENTRE LES NAVIRES PETROLIERS OU LES BARGES VERS LES SITES INDUSTRIELS.

ID		OD		WP		BP		VACUUM	BR/r	W	L
inch	mm	mm	bar	psi	bar	psi	bar	mm	g/m	m	
2"	50.8	68	10	145	40	580	-0.92	200	2280	6 ~ 40	
3"	76.2	97	10	145	40	580	-0.92	400	4055	6 ~ 40	
4"	101.6	128	10	145	40	580	-0.92	500	6820	6 ~ 40	
5"	127	156	10	145	40	580	-0.92	650	9395	6 ~ 40	
6"	152.4	185	10	145	40	580	-0.92	750	13150	6 ~ 40	
8"	203	239	10	145	40	580	-0.92	950	18490	6 ~ 12	

TO BE SPECIFIED : ELECTRICALLY CONTINUOUS OR DISCONTINUOUS
 SPEZIFIZIET : ZWISCHEN VOLL- UND TEILLEICHTFÄHIGKEIT WÄHLBAR.
 DA SPECIFICARE : ELETTIRICAMENTE CONTINUO O DISCONTINUO
 A PRECISER : ELECTRIQUEMENT CONDUCTEUR OU NON-CONDUCTEUR

MARKING / BESCHRIFTUNG / MARCATURA / MARQUAGE

NOTES ON ORDERING
 A - Inside diameter
 B - Length (Overall Length)
 C - Working pressure
 D - Type ends or end fittings
 E - Applications (Much detail as possible)
 F - Working temperature

BEMERKUNGEN ZUM AUFTRAG
 A - Innendurchmesser
 B - Schlauchlänge F-F
 C - Betriebsdruck
 D - Flanschbezeichnung
 E - Einsatzbedingungen (Möglichst viele Information angeben)
 F - Betriebstemperatur

NOTE ORDINI
 A - Diametro interno
 B - Lunghezza (Flange Incluso)
 C - Pressione di lavoro
 D - Specificazioni per le flange
 E - Applicazione (Massimo dettagli possibile)
 F - Temperatura di lavoro

PRECISIONS NECESSAIRES
 A - Diametre interieur
 B - Longueur (Brides incluses)
 C - Pression de service
 D - Specifications des brides
 E - Applications (Plus de details possible)
 F - Temperature de travail

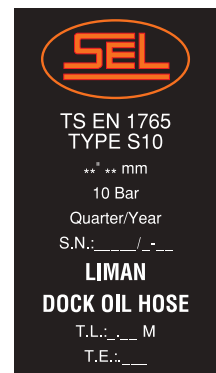

-30°C / + 82°C
 -50°F / +180°F

AROMATIC CONTENT: ≤ % 50

NORMS NORMEN NORME NORMES	TS EN 1765 S10	COLOUR FARBEN COLORI COULEUR	
------------------------------------	----------------	---------------------------------------	--



Built-In Flanges Petroleum S&D Hose For Tankers & Bunkering

EN 1765 Type S10



TUBE : OIL AND PETROL RESISTANT NBR RUBBER.
 REINFORCEMENT : HIGH TENSILE SYNTHETIC TEXTILE, 2 STEEL WIRE HELIX AND ANTISTATIC COPPER WIRE.
 COVER : OIL, WEATHER, OZONE, ABRASION AND SEA WATER RESISTANT, SPECIAL SYNTHETIC RUBBER.
 APPLICATION : FOR SUCTION AND DISCHARGE OF PETROLEUM PRODUCTS WITH AROMATIC CONTENT UP TO 50% FROM TANKERS AND BARGES BUNKERING SERVICES AND INDUSTRIAL APPLICATIONS.



SEELE : ÖL-UND KRAFTSTOFFBESTÄNDIGER NBR-GUMMI.
 EINLAGE : HOCHZUGFESTE SYNTHETISCHE TEXTILENLAGE, 2 STAHLDRAHTSPIRALEN UND ANTISTATISCHER KUPFERLITZE.
 DECKE : ABRIEBFEST, ÖL-, MEERWASSER-, UND WITTERUNGSBESTÄNDIG, SPEZIELER SYNTHETIKGUMMI.
 ANWENDUNG : SAUG UND DRUCKSCHLAUCH FÜR TANKER, BETANKUNGSFAHRZEUGE UND SCHIFFE MIT BENZIN, DIESEL, HEIZÖL UND MINERALÖLE MIT 50% AROMATENGHALT, VULKANISIERT



SOTTOSTRATO : GOMMA NBR, RESISTENTE AI PRODOTTI PETROLIFERI.
 RINFORZO : INSERZIONI TESSILI AD ALTA TENACITÀ CON 2 SPIRALI D'ACCIAIO E CORDICELLA DI RAME ANTISTATICA.
 COPERTURA : GOMMA SPECIALE SINTETICA NERA, RESISTENTE AGLI OLI, ALL'OZONO, ALL'ABRASIONE, AGLI AGENTI ATMOSFERICI ED ALL'ACQUA DI MARE.
 IMPIEGO : ASPIRAZIONE E MANDATA DI PRODOTTI PETROLIFERI CON CONTENUTO AROMATICO FINO AL 50% NEL BUNKERAGGIO ED ALTRE APPLICAZIONI INDUSTRIALI.



TUBE : CAOUTCHOUC NBR, RESISTANT AUX HUILES ET HYDROCARBURES.
 RENFORCEMENT : INSERTION TEXTILE HAUTE TENACITE, 2 SPIRALES EN ACIER ET FIL DE MASSE ANTISTATIQUE.
 REVETEMENT : CAOUTCHOUC SYNTHETIQUE SPECIAL, RESISTANT A L'ABRASION, A L'OZONO, AUX HUILES, A L'EAU DE MER ET AUX AGENTS ATMOSPHERIQUES.
 APPLICATION : POUR ASPIRATION ET REFOULEMENT DES PRODUITS PETROLIERS AVEC TENEUR EN AROMATIQUES JUSQU'A 50% ENTRE LES NAVIRES PETROLIERS OU LES BARGES VERS LES SITES INDUSTRIELS.

ID		OD	WP		BP		VACUUM	BR/r	W	L
inch	mm	mm	bar	psi	bar	psi	bar	mm	g/m	m
2"	50.8	72	10	145	40	580	-0.92	200	3500	6 ~ 40
3"	76.2	100	10	145	40	580	-0.92	400	5560	6 ~ 40
4"	101.6	129	10	145	40	580	-0.92	500	7970	6 ~ 40
5"	127	162	10	145	40	580	-0.92	650	14070	6 ~ 40
6"	152.4	190	10	145	40	580	-0.92	750	17325	6 ~ 40
8"	203	243	10	145	40	580	-0.92	950	24150	6 ~ 12
10"	254	302	10	145	40	580	-0.92	1200	38630	6 ~ 12
12"	305.8	356	10	145	40	580	-0.92	1500	48500	6 ~ 12
14"	355.6	408	10	145	40	580	-0.92	2150	60000	6 ~ 12
16"	406	460	10	145	40	580	-0.92	2800	72500	6 ~ 12

TO BE SPECIFIED : ELECTRICALLY CONTINUOUS OR DISCONTINUOUS
 SPEZIFIZIET : ZWISCHEN VOLL- UND TEILLEICHTFÄHIGKEIT WÄHLBAR.
 DA SPECIFICARE : ELETTRICAMENTE CONTINUO O DISCONTINUO
 A PRECISER : ELECTRIQUEMENT CONDUCTEUR OU NON-CONDUCTEUR

MARKING / BESCHRIFTUNG / MARCATURA / MARQUAGE

NOTES ON ORDERING
 A- Inside diameter
 B- Length (Overall Length)
 C- Working pressure
 D- Type ends or end fittings
 E- Applications (Much detail as possible)
 F- Working temperature

BEMERKUNGEN ZUM AUFTRAG
 A- Innendurchmesser
 B- Schlauchlänge F-F
 C- Betriebsdruck
 D- Flanschbezeichnung
 E- Einsatzbedingungen (Möglichst viele Information angeben)
 F- Betriebstemperatur

NOTE ORDINI
 A- Diametro interno
 B- Lunghezza (Flange Incluso)
 C- Pressione di lavoro
 D- Specificazioni per le flange
 E- Applicazione (Massimo dettagli possibile)
 F- Temperatura di lavoro

PRECISIONS NECESSAIRES
 A- Diametre interieur
 B- Longueur (Brides incluses)
 C- Pression de service
 D- Specifications des brides
 E- Applications (Plus de details possible)
 F- Temperature de travail



-30 °C / + 82 °C
 -50 °F / +180 °F

AROMATIC CONTENT: ≤ % 50

NORMS
 NORMEN
 NORME
 NORMES

TS EN 1765 S10

COLOUR
 FARBEN
 COLORI
 COULEUR

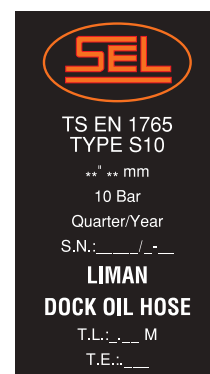

Swaged Flanges Petroleum S&D Hose For Tankers & Bunkering

EN 1765 Type S15



TUBE : OIL AND PETROL RESISTANT NBR RUBBER.
 REINFORCEMENT : HIGH TENSILE SYNTHETIC TEXTILE, 2 STEEL WIRE HELIX AND ANTISTATIC COPPER WIRE.
 COVER : OIL, WEATHER, OZONE, ABRASION AND SEA WATER RESISTANT, SPECIAL SYNTHETIC RUBBER.
 APPLICATION : FOR SUCTION AND DISCHARGE OF PETROLEUM PRODUCTS WITH AROMATIC CONTENT UP TO 50% FROM SHIP TO SHIP OR FROM SHIP TO DOCK.



SEELE : ÖL-UND KRAFTSTOFFBESTÄNDIGER NBR-GUMMI.
 EINLAGE : HOCHZUGFESTE SYNTHETISCHE TEXTILEINLAGE, 2 STAHLDRAHTSPIRALEN UND ANTISTATISCHER KUPFERLITZE.
 DECKE : ABRIEBFEST, ÖL-, MEERWASSER-, UND WITTERUNGSBESTÄNDIG, SPEZIELER SYNTHETIKGUMMI.
 ANWENDUNG : SAUG UND DRUCKSCHLAUCH FÜR SCHIFFE MIT BENZIN, DIESEL, HEIZÖL UND MINERALÖLE MIT 50% AROMATENGEHALT, EINGEPRESST, SCHIFF ZU SCHIFF ODER SCHIFF ZU DOCK VERBINDUNG.



SOTTOSTRATO : GOMMA NBR, RESISTENTE AI PRODOTTI PETROLIFERI.
 RINFORZO : INSERZIONI TESSILI AD ALTA TENACITÀ CON 2 SPIRALI D'ACCIAIO E CORDICELLA DI RAME ANTISTATICA.
 COPERTURA : GOMMA SPECIALE SINTETICA NERA, RESISTENTE AGLI OLI, ALL'OZONO, ALL'ABRASIONE, AGLI AGENTI ATMOSFERICI ED ALL'ACQUA DI MARE.
 IMPIEGO : ASPIRAZIONE E MANDATA DI PRODOTTI PETROLIFERI CON CONTENUTO AROMATICO FINO AL 50% DA NAVE A NAVE O DA NAVE AL BANCHINA.



TUBE : CAOUTCHOUC NBR, RESISTANT AUX HUILES ET HYDROCARBURES.
 RENFORCEMENT : INSERTION TEXTILE HAUTE TENACITE, 2 SPIRALES EN ACIER ET FIL DE MASSE ANTISTATIQUE.
 REVETEMENT : CAOUTCHOUC SYNTHETIQUE SPECIAL, RESISTANT A L'ABRASION, A L'OZONE, AUX HUILES, A L'EAU DE MER ET AUX AGENTS ATMOSPERIQUES.
 APPLICATION : POUR ASPIRATION ET REFOULEMENT DES PRODUITS PETROLIERS AVEC TENEUR EN AROMATIQUES JUSQU'A 50% DE NAVIRE A NAVIRE OU ENTRE LE NAVIRE ET LE QUAI.

ID		OD		WP		BP		VACUUM	BR/r	W	L
inch	mm	mm	bar	psi	bar	psi	bar	mm	g/m	m	
2"	50,8	70	15	217,5	60	870	-0,92	200	2695	6 ~ 40	
3"	76,2	100	15	217,5	60	870	-0,92	400	4610	6 ~ 40	
4"	101,6	130	15	217,5	60	870	-0,92	500	6980	6 ~ 40	
5"	127	158	15	217,5	60	870	-0,92	650	9650	6 ~ 40	
6"	152,4	188	15	217,5	60	870	-0,92	750	14385	6 ~ 40	
8"	203	242	15	217,5	60	870	-0,92	950	20170	6 ~ 12	

TO BE SPECIFIED : ELECTRICALLY CONTINUOUS OR DISCONTINUOUS
 SPEZIFIZIET : ZWISCHEN VOLL- UND TEILLEICHTFÄHIGKEIT WÄHLBAR.
 DA SPECIFICARE : ELETTIRICAMENTE CONTINUO O DISCONTINUO
 A PRECISER : ELECTRIQUEMENT CONDUCTEUR OU NON-CONDUCTEUR

MARKING / BESCHRIFTUNG / MARCATURA / MARQUAGE

NOTES ON ORDERING

A - Inside diameter
 B - Length (Overall Length)
 C - Working pressure
 D - Type ends or end fittings
 E - Applications (Much detail as possible)
 F - Working temperature

BEMERKUNGEN ZUM AUFTRAG

A - Innendurchmesser
 B - Schlauchlänge F-F
 C - Betriebsdruck
 D - Flanschbezeichnung
 E - Einsatzbedingungen (Möglichst viele Information angeben)
 F - Betriebstemperatur

NOTE ORDINI

A - Diametro interno
 B - Lunghezza (Flange Incluso)
 C - Pressione di lavoro
 D - Specificazioni per le flange
 E - Applicazione (Massimo dettagli possibile)
 F - Temperatura di lavoro

PRECISIONS NECESSAIRES

A - Diametre interieur
 B - Longueur (Brides incluses)
 C - Pression de service
 D - Specifications des brides
 E - Applications (Plus de details possible)
 F - Temperature de travail

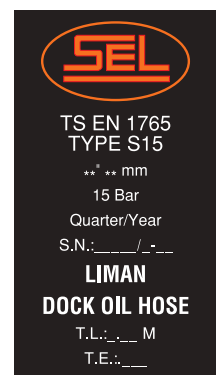

-30°C / + 82°C
 -50°F / +180°F

AROMATIC CONTENT: ≤ % 50

NORMS NORMEN NORME NORMES	TS EN 1765 S15	COLOUR FARBEN COLORI COULEUR	
------------------------------------	----------------	---------------------------------------	--



Built-In Flanges Petroleum S&D Hose For Tankers & Bunkering

EN 1765 Type S15

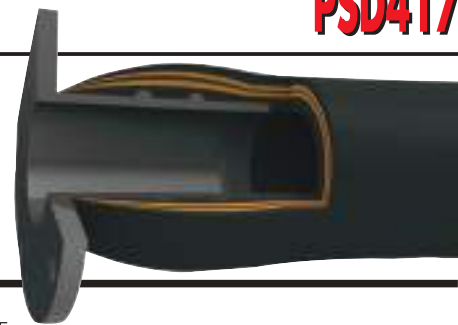

TUBE : OIL AND PETROL RESISTANT NBR RUBBER.
 REINFORCEMENT : HIGH TENSILE SYNTHETIC TEXTILE, 2 STEEL WIRE HELIX AND ANTISTATIC COPPER WIRE.
 COVER : OIL, WEATHER, OZONE, ABRASION AND SEA WATER RESISTANT, SPECIAL SYNTHETIC RUBBER.
 APPLICATION : FOR SUCTION AND DISCHARGE OF PETROLEUM PRODUCTS WITH AROMATIC CONTENT UP TO 50% FROM SHIP TO SHIP OR FROM SHIP TO DOCK.



SEELE : ÖL-UND KRAFTSTOFFBESTÄNDIGER NBR-GUMMI.
 EINLAGE : HOCHZUGFESTE SYNTHETISCHE TEXTILEINLAGE, 2 STAHLDRAHTSPIRALEN UND ANTISTATISCHER KUPFERLITZE.
 DECKE : ABRIEFEST, ÖL-, MEERWASSER-, UND WITTERUNGSBESTÄNDIG, SPEZIELER SYNTHETIKGUMMI.
 ANWENDUNG : SAUG UND DRUCKSCHLAUCH FÜR SCHIFFE MIT BENZIN, DIESEL, HEIZÖL UND MINERALÖLE MIT 50% AROMATENGEHALT, VULKANISIERT, SCHIFF ZU SCHIFF ODER SCHIFF ZU DOCK VERBINDUNG.



SOTTOSTRATO : GOMMA NBR, RESISTENTE AI PRODOTTI PETROLIFERI.
 RINFORZO : INSERZIONI TESSILI AD ALTA TENACITÀ CON 2 SPIRALI D'ACCIAIO E CORDICELLA DI RAME ANTISTATICA.
 COPERTURA : GOMMA SPECIALE SINTETICA NERA, RESISTENTE AGLI OLI, ALL'OZONO, ALL' ABRASION, AGLI AGENTI ATMOSFERICI ED ALL'ACQUA DI MARE.
 IMPIEGO : ASPIRAZIONE E MANDATA DI PRODOTTI PETROLIFERI CON CONTENUTO AROMATICO FINO AL 50% DA NAVE A NAVE O DA NAVE AL BANCHINA.



TUBE : CAOUTCHOUC NBR, RESISTANT AUX HUILES ET HYDROCARBURES.
 RENFORCEMENT : INSERTION TEXTILE HAUTE TENACITE, 2 SPIRALES EN ACIER ET FIL DE MASSE ANTISTATIQUE.
 REVETEMENT : CAOUTCHOUC SYNTHETIQUE SPECIAL, RESISTANT A L'ABRASION, A L'OZONE, AUX HUILES, A L'EAU DE MER ET AUX AGENTS ATMOSPHERIQUES.
 APPLICATION : POUR ASPIRATION ET REFOULEMENT DES PRODUITS PETROLIERS AVEC TENEUR EN AROMATIQUES JUSQU'A 50% DE NAVIRE A NAVIRE OU ENTRE LE NAVIRE ET LE QUAI.

ID		OD		WP		BP		VACUUM	BR/r	W	L
inch	mm	mm	bar	psi	bar	psi	bar	mm	g/m	m	
2"	50.8	74	15	217,5	60	870	-0.92	200	3900	6 ~ 40	
3"	76.2	104	15	217,5	60	870	-0.92	400	6150	6 ~ 40	
4"	101.6	134	15	217,5	60	870	-0.92	500	9350	6 ~ 40	
5"	127	162	15	217,5	60	870	-0.92	650	13750	6 ~ 40	
6"	152.4	190	15	217,5	60	870	-0.92	750	17450	6 ~ 40	
8"	203	245	15	217,5	60	870	-0.92	950	25000	6 ~ 12	
10"	254	303	15	217,5	60	870	-0.92	1200	38250	6 ~ 12	
12"	305.8	362	15	217,5	60	870	-0.92	1500	50750	6 ~ 12	
14"	355.6	416	15	217,5	60	870	-0.92	2150	65225	6 ~ 12	
16"	406	479	15	217,5	60	870	-0.92	2800	82250	6 ~ 12	

TO BE SPECIFIED : ELECTRICALLY CONTINUOUS OR DISCONTINUOUS
 SPEZIFIZIET : ZWISCHEN VOLL- UND TEILLEICHTFÄHIGKEIT WÄHLBAR.
 DA SPECIFICARE : ELETTIRICAMENTE CONTINUO O DISCONTINUO
 A PRECISER : ELECTRIQUEMENT CONDUCTEUR OU NON-CONDUCTEUR

MARKING / BESCHRIFTUNG / MARCATURA / MARQUAGE

NOTES ON ORDERING
 A- Inside diameter
 B- Length (Overall Length)
 C- Working pressure
 D- Type ends or end fittings
 E- Applications (Much detail as possible)
 F- Working temperature

BEMERKUNGEN ZUM AUFTRAG
 A- Innendurchmesser
 B- Schlauchlänge F-F
 C- Betriebsdruck
 D- Flanschbezeichnung
 E- Einsatzbedingungen (Möglichst viele Information angeben)
 F- Betriebstemperatur

NOTE ORDINI
 A- Diametro interno
 B- Lunghezza (Flange Incluso)
 C- Pressione di lavoro
 D- Specificazioni per le flange
 E- Applicazione (Massimo dettagli possibile)
 F- Temperatura di lavoro

PRECISIONS NECESSAIRES
 A- Diametre interieur
 B- Longueur (Brides incluses)
 C- Pression de service
 D- Specifications des brides
 E- Applications (Plus de details possible)
 F- Temperature de travail

TS EN 1765
 TYPE S15
 ** ** mm
 15 Bar
 Quarter/Year
 S.N.: ____ / ____
LIMAN
DOCK OIL HOSE
 T.L.: ____ M
 T.E.: ____



-30°C / + 82°C
 -50°F / +180°F

AROMATIC CONTENT: ≤ % 50

NORMS NORMEN NORME NORMES	TS EN 1765 S15	COLOUR FARBEN COLORI COULEUR	
------------------------------------	----------------	---------------------------------------	--

Asphalt S&D



 TUBE : HEAT RESISTANT, SPECIAL SYNTHETIC ACRYLIC RUBBER.
 REINFORCEMENT : HIGH TENSILE SYNTHETIC TEXTILE, 2 STEEL WIRE HELIX AND ANTISTATIC COPPER WIRE.
 COVER : ABRASION, HEAT, WEATHER, OIL AND ASPHALT RESISTANT SPECIAL SYNTHETIC RUBBER.
 APPLICATION : FOR SUCTION AND DISCHARGE OF TAR AND HOT ASPHALT ON TANK TRUCKS & TANK CARS ETC. IN ROAD CONSTRUCTIONS UP TO 180 °C.

 SEELE : HITZEBESTÄNDIGER, SPEZIELLER SYNTHETIC ACRYLIC-GUMMI.
 EINLAGE : HOCHZUGFESTE SYNTHETISCHE TEXTILEINLAGE, 2 STAHLDRAHTSPIRALEN UND ANTISTATISCHER KUPFERLITZE.
 DECKE : ABRIEBFEST, HITZE-, OZON-, WITTERUNGSBESTÄNDIGER SPEZIELLER GUMMI, BESTÄNDIG GEGEN ÖLE UND ASPHALT.
 ANWENDUNG : SAUG UND DRUCKSCHLAUCH FÜR FAHRZEUGE MIT HEISSEM TEER UND ASPHALT BEI TEMPERATUREN VON BIS ZU 180°C.

 SOTTOSTRATO : GOMMA SPECIALE SINTETICA ACRILICA RESISTENTE AL CALORE.
 RINFORZO : INSERZIONI TESSILI AD ALTA TENACITÀ CON 2 SPIRALE D'ACCIAIO E CORDICELLA DI RAME ANTISTATICA.
 COPERTURA : GOMMA SPECIALE SINTETICA CON OTTIMA RESISTENZA AL BITUME CALDO ALL' ABRASIONE, OLII, ED AGLI AGENTI ATMOSFERICI.
 IMPIEGO : PER IL CARICO E LO SCARICO DI BITUME CALDO FINO A 180 °C NEI CAMION, NEI VAGONI CISTERNA ETC. NELLE COSTRUZIONI STRADALI.

 TUBE : CAOUTCHOUC ACRYLIQUE SYNTHETIQUE SPECIAL RESISTANT A LA CHALEUR.
 RENFORCEMENT : INSERTION TEXTILE HAUTE TENACITE, 2 SPIRALES EN ACIER ET FIL DE MASSE ANTISTATIQUE.
 REVETEMENT : CAOUTCHOUC SYNTHETIQUE SPECIAL, RESISTANT A L'ABRASION, A LA CHALEUR, BITUME CHAUD ET AUX AGENTS ATMOSPHERIQUES.
 APPLICATION : POUR ASPIRATION ET REFOULEMENT DE GOUDRON ET BITUME CHAUD JUSQU'A 180 °C. POUR LA FABRICATION DES ROUTES.

ID		OD		WP		BP		VACUUM	BR/r	W	L
inch	mm	mm	bar	psi	bar	psi	bar	mm	g/m	m	
1"	25.4	43	18	261	54	783	-0.92	115	1238	40-46-61	
1 1/4"	32	50	18	261	54	783	-0.92	150	1496	40-46-61	
1 1/2"	38	56	18	261	54	783	-0.92	180	1830	40-46-61	
1 3/4"	44.5	64	18	261	54	783	-0.92	220	2344	40-46-61	
2"	50.8	71	18	261	54	783	-0.92	250	2776	40-46-61	
2 1/2"	63.5	83	10	145	30	435	-0.92	320	3129	40-46-61	
3"	76.2	97	10	145	30	435	-0.92	400	4107	40-46-61	
4"	101.6	126	10	145	30	435	-0.92	520	6168	40-46-61	
5"	127	153	10	145	30	435	-0.92	680	8152	40-46-61	
6"	152.4	179	10	145	30	435	-0.92	850	10229	40-46-61	

* THE HOSE MUST BE PROPERLY DRAINED AND CLEANED FROM THE TAR AFTER BEING USED.
 * DER SCHLAUCH MUSS NACH JEDEM GEBRAUCH VOM TEER BEFREIT UND GESAEUBERT WERDEN
 * I TUBI VANNO DRENATI E OPPORTUNAMENTE PULITI DAL BITUME UNA VOLTA TERMINATA L'OPERAZIONE
 * LE TUYAU DOIT ETRE BIEN VIDE ET NETTOYE DE BITUME APRES UTILISATION



-40°C /+180°C
 -40°F /+ 356°F

MARKING / BESCHRIFTUNG / MARCATURA / MARQUAGE: **TRANSFER TAPE OR EMBOSSED**

SEL ASPHALT ASPHALT S/D HOSE - W.P. * BAR (**** PSI) 180 °C**

NORMS NORMEN NORME NORMES	ISO 1307	COLOUR FARBEN COLORI COULEUR	
------------------------------------	----------	---------------------------------------	--

Aircraft Refueling

EN 1361 Type B



TUBE : AVIATION GASOLINES AND JET FUELS RESISTANT, CONDUCTIVE NBR RUBBER.
 REINFORCEMENT : HIGH TENSILE SYNTHETIC TEXTILE AND 2 ANTISTATIC COPPER WIRE.
 COVER : ABRASION, OZONE, WEATHER, HEAT AND OIL RESISTANT SPECIAL SYNTHETIC RUBBER.
 APPLICATION : FOR THE GROUND REFUELLING OF AIRCRAFTS HAVING AN AROMATIC CONTENT UP TO 30 %.



SEELE : FLUGZEUG- UND JETKRAFTSTOFFBESTÄNDIG, ISOLIEREND, NBR GUMMI, SCHWARZ.
 EINLAGE : HOCHZUGSFESTE SYNTETISCHE TEXTILEINLAGE UND 2 ANTISTATISCHER KUPFERLITZE ZUR BESSEREN LEITFÄHIGKEIT.
 DECKE : ABRIEFEST, OZON-, WETTER-, HITZE- UND ÖLBESTÄNDIG, SPEZIELLER SYNTHETIKGUMMI.
 ANWENDUNG : ZUR FLUGZEUGBETÄNKUNG AM BODEN, MIT 30% MAX. AROMATENANTEIL.



SOTTOSTRATO : GOMMA NBR CONDUTTIVA, RESISTENTE AGLI OLI ED AI CARBURANTI DEGLI AEREI.
 RINFORZO : INSERZIONI TESSILI AD ALTA TENACITÀ E 2 CORDICELLE DI RAME ANTISTATICHE.
 COPERTURA : GOMMA SPECIALE SINTETICA RESISTENTE AGLI OLI MINERALI, ALL'OZONO, ALL'ABRASIONE ED AGLI AGENTI ATMOSFERICI.
 IMPIEGO : PER RIFORNIMENTO A TERRA D'AEREI CON OLI E CARBURANTI CON CONTENUTO AROMATICO FINO AL 30%.



TUBE : CAOUTCHOUC NBR CONDUCTEUR, RESISTANT AUX CARBURANTS AERONAUTIQUES.
 RENFORCEMENT : INSERTION TEXTILE HAUTE TENACITE ET 2 FILS DE MASSE ANTISTATIQUES.
 REVETEMENT : CAOUTCHOUC SYNTHETIQUE SPECIAL, RESISTANT AUX HUILES, A L'OZONE, A LA CHALEUR ET AUX AGENTS ATMOSPHERIQUES.
 APPLICATION : POUR L'AVITAILLEMENT AU SOL DES AERONEFS DE CARBURANT AVEC TENEUR EN AROMATIQUES JUSQU'A 30%.

ID		OD	WP		BP		BR/r	W	L
inch	mm	mm	bar	psi	bar	psi	mm	g/m	m
3/4"	19	29	20	290	80	1160	113	522	40-46-61
1"	25.4	38	20	290	80	1160	150	842	40-46-61
1 1/4"	32	45	20	290	80	1160	190	1003	40-46-61
1 1/2"	38	51	20	290	80	1160	225	1162	40-46-61
2"	50.8	65	20	290	80	1160	275	1699	40-46-61
2 1/2"	63.5	79	20	290	80	1160	300	2063	40-46-61
3"	76.2	92	20	290	80	1160	300	2562	40-46-61
4"	101.6	120	20	290	80	1160	450	3734	40-46-61



-30°C / + 65°C
 -22°F / +149°F



MARKING / BESCHRIFTUNG / MARCATURA / MARQUAGE: **TRANSFER TAPE OR EMBOSSED**

SEL AERO - B AIRCRAFT REFUELING HOSE - TS EN 1361 TYPE B - M - W.P. 20 BAR (290 PSI)

NORMS NORMEN NORME NORMES	EN ISO 1825 TYPE-B TS EN 1361 TYPE - B TS EN ISO 1825 TYPE-B	COLOUR FARBEN COLORI COULEUR	
------------------------------------	--	---------------------------------------	--

Aircraft Refueling

EN 1361 Type C



TUBE : AVIATION GASOLINES AND JET FUELS RESISTANT, CONDUCTIVE NBR RUBBER.
 REINFORCEMENT : HIGH TENSILE SYNTHETIC TEXTILE BRAID.
 COVER : ABRASION, OZONE, WEATHER, HEAT AND OIL RESISTANT SPECIAL SYNTHETIC RUBBER.
 APPLICATION : FOR THE GROUND REFUELLING OF AIRCRAFTS HAVING AN AROMATIC CONTENT UP TO 30 %.



SEELE : FLUGZEUG- UND JETKRAFTSTOFFBESTÄNDIG, ISOLIEREND, NBR GUMMI, SCHWARZ.
 EINLAGE : HOCHZUGSFESTE SYNTETISCHE TEXTILEINLAGE.
 DECKE : ABRIEFEST, OZON-, WETTER-, HITZE- UND ÖLBESTÄNDIG, SPEZIELLER SYNTHETIKGUMMI.
 ANWENDUNG : ZUR BETANKUNG VON FLUGZEUGEN, MIT 30% MAX. AROMATENANTEIL.



SOTTOSTRATO : GOMMA NBR CONDUTTIVA, RESISTENTE AGLI OLI ED AI CARBURANTI DEGLI AEREI.
 RINFORZO : TRECCIA TESSILE AD ALTA TENACITÀ.
 COPERTURA : GOMMA SPECIALE SINTETICA NERA RESISTENTE AGLI OLI MINERALI, ALL'OZONO, ALL'ABRASIONE ED AGLI AGENTI ATMOSFERICI.
 IMPIEGO : PER RIFORMIMENTO A TERRA D'AEREI CON OLI E CARBURANTI CON CONTENUTO AROMATICO FINO AL 30%.



TUBE : CAOUTCHOUC NBR CONDUCTEUR, RESISTANT AUX CARBURANTS AERONAUTIQUES.
 RENFORCEMENT : TRESSE TEXTILE HAUTE TENACITE.
 REVETEMENT : CAOUTCHOUC SYNTHETIQUE SPECIAL, RESISTANT AUX HUILES, A L'ABRASION, A L'OZONE, A LA CHALEUR ET AUX AGENTS ATMOSPHERIQUES.
 APPLICATION : POUR L'AVITAILLEMENT AU SOL DES AERONEFS DE CARBURANT AVEC TENEUR EN AROMATIQUES JUSQU'A 30%.

ID		OD	WP		BP		BR/r	W	L
inch	mm	mm	bar	psi	bar	psi	mm	g/m	m
3/4"	19	29	20	290	80	1160	113	522	40-46-61
1"	25.4	38	20	290	80	1160	150	840	40-46-61
1 1/4"	32	45	20	290	80	1160	190	1000	40-46-61
1 1/2"	38	51	20	290	80	1160	225	1155	40-46-61
2"	50.8	65	20	290	80	1160	275	1710	40-46-61
2 1/2"	63.5	79	20	290	80	1160	300	2070	40-46-61
3"	76.2	92	20	290	80	1160	300	2580	40-46-61
4"	101.6	120	20	290	80	1160	450	3760	40-46-61



-30°C / + 65°C
 -22°F / +149°F



MARKING / BESCHRIFTUNG / MARCATURA / MARQUAGE: **TRANSFER TAPE OR EMBOSSED**

SEL AERO - C AIRCRAFT REFUELING HOSE - TS EN 1361 TYPE C - Q - W.P. 20 BAR (290 PSI)

NORMS NORMEN NORME NORMES	EN ISO 1825 TYPE - C TS EN 1361 TYPE - C TS EN ISO 1825 TYPE - C	COLOUR FARBEN COLORI COULEUR	
------------------------------------	--	---------------------------------------	--



Aircraft Refueling S&D

EN 1361 Type E



TUBE : AVIATION GASOLINES AND JET FUELS RESISTANT, CONDUCTIVE NBR RUBBER.
 REINFORCEMENT : HIGH TENSILE SYNTHETIC TEXTILE, 2 STEEL WIRE HELIX AND 2 ANTISTATIC COPPER WIRE.
 COVER : ABRASION, OZONE, WEATHER, HEAT AND OIL RESISTANT SPECIAL SYNTHETIC RUBBER.
 APPLICATION : FOR THE GROUND REFUELLING AND FUEL DISCHARGING OF AIRCRAFTS HAVING AN AROMATIC CONTENT UP TO 30 %.



SEELE : LUGZEUG- UND JETKRAFTSTOFFBESTÄNDIG, ISOLIEREND, NBR GUMMI, SCHWARZ.
 EINLAGE : HOCHZUGSFESTE SYNTETISCHE TEXTILEINLAGE, 2 STAHLDRAHTSPIRALEN UND 2 ANTISTATISCHER KUPFERLITZEN ZUR BESSEREN LEITFÄHIGKEIT.
 DECKE : ABRIEBFEST, OZON-, WETTER-, HITZE-, UND ÖLBESTÄNDIG, SPEZIELLER SYNTHETIKGUMMI.
 ANWENDUNG : ZUR BE- UND ENTTANKUNG VON FLUGZEUGEN, MIT 30% MAX. AROMATENANTEIL.



SOTTOSTRATO : GOMMA NBR CONDUTTIVA, RESISTENTE AGLI OLI ED AI CARBURANTI DEGLI AEREI.
 RINFORZO : INSERZIONI TESSILI AD ALTA TENACITÀ CON 2 SPIRALI D'ACCIAIO E 2 CORDICELLE DI RAME ANTISTATICHE.
 COPERTURA : GOMMA SPECIALE SINTETICA NERA RESISTENTE AGLI OLI MINERALI, ALL'OZONO, ALL'ABRASIONE ED AGLI AGENTI ATMOSFERICI.
 IMPIEGO : PER RIFORNIMENTO A TERRA D'AEREI CON OLI E CARBURANTI CON CONTENUTO AROMATICO FINO AL 30%.



TUBE : CAOUTCHOUC NBR CONDUCTEUR, RESISTANT AUX CARBURANTS AERONAUTIQUES.
 RENFORCEMENT : INSERTION TEXTILE HAUTE TENACITE, 2 SPIRALES EN ACIER ET 2 FILS DE MASSE ANTISTATIQUES.
 REVETEMENT : CAOUTCHOUC SYNTHETIC SPECIAL, RESISTANT AUX HUILES, A L'ABRASION, A L'OZONO, A LA CHALEUR ET AUX AGENTS ATMOSPHERIQUES.
 APPLICATION : POUR L'AVITAILLEMENT AU SOL DES AERONEFS DE CARBURANT ET REFOULEMENT DES AVIONS AVEC TENEUR EN AROMATIQUES JUSQU'A 30%.

ID		OD		WP		BP		VACUUM	BR/r	W	L
inch	mm	mm	mm	bar	psi	bar	psi	bar	mm	g/m	m
3/4"	19	31	20	290	80	1160	-0.92	113	686	40-46-61	
1"	25.4	39	20	290	80	1160	-0.92	150	972	40-46-61	
1 1/4"	32	46	20	290	80	1160	-0.92	190	1218	40-46-61	
1 1/2"	38	53	20	290	80	1160	-0.92	225	1592	40-46-61	
2"	50.8	67	20	290	80	1160	-0.92	275	2320	40-46-61	
2 1/2"	63.5	81	20	290	80	1160	-0.92	300	2860	40-46-61	
3"	76.2	95	20	290	80	1160	-0.92	300	3701	40-46-61	
4"	101.6	123	20	290	80	1160	-0.92	450	5166	40-46-61	



-30°C / + 65°C
 -22°F / +149°F



MARKING / BESCHRIFTUNG / MARCATURA / MARQUAGE: **TRANSFER TAPE OR EMBOSSED**

SEL AERO - E AIRCRAFT REFUELING HOSE - TS EN 1361 TYPE E - M - W.P. 20 BAR (290 PSI)

NORMS NORMEN NORME NORMES	EN ISO 1825 TYPE - E TS EN 1361 TYPE - E TS EN ISO 1825 TYPE - E	COLOUR FARBEN COLORI COULEUR	
------------------------------------	--	---------------------------------------	--

LPG Discharge-Ω

EN 1762



TUBE : LPG RESISTANT, CONDUCTIVE BLACK NBR RUBBER.
 REINFORCEMENT : HIGH TENSILE SYNTHETIC TEXTILE.
 COVER : OZONE, WEATHER, HEAT, FLAME AND OIL RESISTANT, SPECIAL PIN-PRICKED SYNTHETIC RUBBER.
 APPLICATION : FOR DELIVERY OF LPG.



SEELE : LPG-BESTÄNDIG, NITRIL-GUMMI SCHWARZ, ISOLIEREND.
 EINLAGE : HOCHZUGFESTE SYNTHETISCHE TEXTILEINLAGE.
 DECKE : ABRIEBFEST, OZON-, WETTER-, HITZE- UND ÖLBESTÄNDIG, FLAMMWIDRIGER, GEPRICKTER, SPEZIELLER SYNTHETIKGUMMI.
 ANWENDUNG : LPG FÜLLSYSTEME.



SOTTOSTRATO : GOMMA NBR NERA CONDUTTIVA, RESISTENTE AL GPL.
 RINFORZO : INSERZIONI TESSILI AD ALTA TENACITÀ.
 COPERTURA : GOMMA SPECIALE SINTETICA NERA MICRO-FORATA, RESISTENTE AGLI OLI, ALLA FIAMMA, ALL'OZONO, ED AGLI AGENTI ATMOSFERICI.
 IMPIEGO : PER MANDATA DI GPL.



TUBE : CAOUTCHOUC NBR, CONDUCTEUR, RESISTANT AU GPL.
 REINFORCEMENT : INSERTION TEXTILE HAUTE TENACITE.
 REVETEMENT : CAOUTCHOUC SYNTHETIQUE SPECIAL, MICRO-PERFORE, RESISTANT AUX HUILES, A L'OZONE, A LA CHALEUR, A LA FLAMME ET AUX AGENTS ATMOSPHERIQUES.
 APPLICATION : POUR REFOULEMENT DE GPL.

ID		OD		WP		BP		BR/r	W	L
inch	mm	mm	bar	psi	bar	psi	mm	g/m	m	
1/2"	12.7	23	25	363	100	1450	100	392	40-46-61	
5/8"	16	26	25	363	100	1450	125	466	40-46-61	
3/4"	19	31	25	363	100	1450	160	630	40-46-61	
1"	25.4	38	25	363	100	1450	200	835	40-46-61	
1 1/4"	32	45	25	363	100	1450	250	1051	40-46-61	
1 1/2"	38	52	25	363	100	1450	320	1210	40-46-61	
2"	50.8	67	25	363	100	1450	400	1832	40-46-61	
2 1/2"	63.5	81	25	363	100	1450	550	2502	40-46-61	
3"	76.2	94	25	363	100	1450	650	3020	40-46-61	
4"	101.6	120	25	363	100	1450	800	3865	40-46-61	



CODE 278 : TYPE D: -30°C /+70°C (-22°F / + 158°F)
 CODE 27D : TYPE D-LT: -50°C /+70°C (-58°F / + 158°F)



MARKING / BESCHRIFTUNG / MARCATURA / MARQUAGE: **TRANSFER TAPE OR EMBOSSED**

SEL LPG / D	LPG HOSE - TS EN 1762 TYPE D - Ω W.P. 25 Bar (363 PSI)				
SEL LPG / D - LT	LPG HOSE - TS EN 1762 TYPE D - LT - Ω W.P. 25 Bar (363 PSI)				

NORMS NORMEN NORME NORMES	TS EN 1762 TYPE - D TS EN 1762 TYPE - D - LT	COLOUR FARBEN COLORI COULEUR	
------------------------------------	---	---------------------------------------	--

LPG S&D - Ω



EN 1762



TUBE : LPG RESISTANT, CONDUCTIVE, BLACK NBR RUBBER.
 REINFORCEMENT : HIGH TENSILE SYNTHETIC TEXTILE, STAINLESS STEEL WIRE HELIX.
 COVER : OZONE, WEATHER, HEAT, FLAME AND OIL RESISTANT, SPECIAL PIN-PRICKED SYNTHETIC RUBBER.
 APPLICATION : FOR SUCTION AND DELIVERY OF LPG.



SEELE : LPG-BESTÄNDIG, NITRIL-GUMMI SCHWARZ, ISOLIEREND.
 EINLAGE : HOCHZUGFESTE SYNTHETISCHE TEXTILEINLAGE UND ROSTFREIEM STAHLDRAHT.
 DECKE : ABRIEBFEST, OZON-, WETTER-, HITZE- UND ÖLBESTÄNDIG, FLAMMWIDRIGER, GEPRICKTER, SPEZIELLER SYNTHETIKGUMMI.
 ANWENDUNG : LPG FÜLLSYSTEME, S&D.



SOTTOSTRATO : GOMMA NBR NERA CONDUTTIVA, RESISTENTE AL GPL.
 RINFORZO : INSERZIONI TESSILI AD ALTA TENACITÀ CON SPIRALE D'ACCIAIO INOX.
 COPERTURA : GOMMA SPECIALE SINTETICA NERA MICRO-FORATA, RESISTENTE AGLI OLI, ALLA FIAMMA, ALL'OZONO ED AGLI AGENTI ATMOSFERICI.
 IMPIEGO : PER ASPIRAZIONE E MANDATA DI GPL.



TUBE : CAOUTCHOUC NBR, CONDUCTEUR, RESISTANT AU GPL.
 REINFORCEMENT : INSERTION TEXTILE HAUTE TENACITE ET SPIRALE EN ACIER INOX.
 REVETEMENT : CAOUTCHOUC SYNTHETIQUE SPECIAL, MICROPERFORE, RESISTANT AUX HUILES, A L'OZONE, A LA CHALEUR, A LA FLAMME ET AUX AGENTS ATMOSPHERIQUES.
 APPLICATION : POUR ASPIRATION ET REFOULEMENT DE GPL.

ID		OD		WP		BP		VACUUM	BR/r	W	L
inch	mm	mm	mm	bar	psi	bar	psi	bar	mm	g/m	m
1/2"	12.7	23	25	363	100	1450	-0.80	90	441	40-46-61	
5/8"	16	26	25	363	100	1450	-0.80	95	519	40-46-61	
3/4"	19	31	25	363	100	1450	-0.80	100	681	40-46-61	
1"	25.4	38	25	363	100	1450	-0.80	150	902	40-46-61	
1 1/4"	32	45	25	363	100	1450	-0.80	200	1174	40-46-61	
1 1/2"	38	52	25	363	100	1450	-0.80	280	1504	40-46-61	
2"	50.8	67	25	363	100	1450	-0.80	350	2196	40-46-61	
2 1/2"	63.5	81	25	363	100	1450	-0.80	480	2909	40-46-61	
3"	76.2	94	25	363	100	1450	-0.80	550	3577	40-46-61	
4"	101.6	120	25	363	100	1450	-0.80	720	4557	40-46-61	



CODE 279 : TYPE SD: -30°C /+ 70°C (-22°F / + 158°F)
 CODE 27S : TYPE SD-LTS: -50°C /+70°C (-58°F / + 158°F)



MARKING / BESCHRIFTUNG / MARCATURA / MARQUAGE: **TRANSFER TAPE OR EMBOSSED**

	LPG / SD	LPG HOSE - TS EN 1762 TYPE SD - Ω W.P. 25 BAR (363 PSI)		
	LPG / SD - LTS	LPG HOSE - TS EN 1762 TYPE SD - LTS - Ω W.P. 25 BAR (363 PSI)		

NORMS NORMEN NORME NORMES	TS EN 1762 TYPE : SD TS EN 1762 TYPE : SD - LTS	COLOUR FARBEN COLORI COULEUR	
------------------------------------	--	---------------------------------------	--

Oil Nitrile Tube



TUBE : OIL AND FUEL RESISTANT NITRILE RUBBER.
APPLICATION : OIL DISCHARGE SERVICES.



SEELE : ÖL-UND KRAFTSTOFFBESTÄNDIGER NITRIL-GUMMI.
ANWENDUNG : ÖL-UND KRAFTSTOFFRÜCKLAUFSCHLAUCH.



SOTTOSTRATO : GOMMA NITRILICA NERA, RESISTENTE AGLI OLI ED AL GASOLIO.
IMPIEGO : MANDATA DI GASOLIO E DI BENZINA.



TUBE : CAOUTCHOUC NITRILE RESISTANT AUX HUILES ET HYDROCARBURES.
APPLICATION : POUR REFOULEMENT DES HYDROCARBURES.

ID		OD	WP		BP		BR/r	W	L
inch	mm	mm	bar	psi	bar	psi	mm	g/m	m
-	3.2	6	-	-	-	-	-	30	>10
-	3.5	6.5	-	-	-	-	-	35	>10
-	4	7	-	-	-	-	-	40	>10
-	4.5	8	-	-	-	-	-	50	>10
-	5	9	-	-	-	-	-	65	>10
-	5.5	9.5	-	-	-	-	-	70	>10
-	6	10	-	-	-	-	-	75	>10
-	7	11	-	-	-	-	-	80	>10
-	7.5	11	-	-	-	-	-	75	>10
-	8	12	-	-	-	-	-	90	>10
-	10	14	-	-	-	-	-	110	>10
-	12	18	-	-	-	-	-	205	>10
-	16	22	-	-	-	-	-	260	>10
-	19	26	-	-	-	-	-	360	>10



-35°C / + 70°C
-31°F / +158°F

MARKING / BESCHRIFTUNG / MARCATURA / MARQUAGE: **EMBOSSED OR INK JET**

SEL OIL TUBE ONT020 I.D. (mm) x O.D. (mm) (YEAR)



NORMS
NORMEN
NORME
NORMES

ISO 1307

COLOUR
FARBEN
COLORI
COULEUR



Textile Reinforced Oil

10 NL - 20 NL

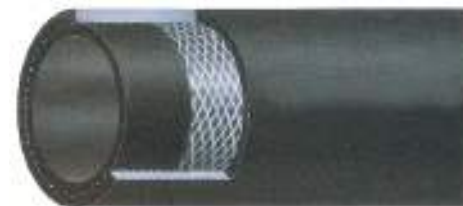

TUBE : FUEL AND OIL RESISTANT, SMOOTH NBR RUBBER.
 REINFORCEMENT : HIGH TENSILE SYNTHETIC TEXTILE.
 COVER : ABRASION, OZONE, WEATHER AND OIL RESISTANT SPECIAL SYNTHETIC RUBBER.
 APPLICATION : FOR DELIVERY OF FUELS IN INTERNAL COMBUSTION ENGINES FOR LUBRIFICATION AND GREASING SERVICES.



SEELE : KRAFTSTOFF- UND ÖLBESTÄNDIG, ISOLIEREND, NBR, GLATT.
 EINLAGE : HOCHZUGFESTE SYNTHETISCHE TEXTILEINLAGE.
 DECKE : ABRIEBFEST, ÖL-, OZON- UND WITTERUNGSBESTÄNDIG, SPEZIELLER SYNTHETIK GUMMI.
 ANWENDUNG : KRAFTSTOFFSCHLAUCH FÜR KRAFTFAHRZEUGE UND FETTPUMPEN.



SOTTOSTRATO : GOMMA NBR LISCIA NERA, RESISTENTE AGLI OLI ED AI CARBURANTI.
 RINFORZO : INSERZIONI TESSILI AD ALTA TENACITÀ.
 COPERTURA : GOMMA SPECIALE LISCIA NERA, RESISTENTE AGLI OLI, AI CARBURANTI, ALL' ABRASIONE, ED AGLI AGENTI ATMOSFERICI.
 IMPIEGO : PER MANDATA DI CARBURANTI NEI MOTORI A COMBUSTIONE INTERNA E PER LUBRIFICAZIONE ED INGRASSAGGIO NEI VARI SERVIZI.



TUBE : CAOUTCHOUC NBR LISSE, RESISTANT AUX HUILES ET HYDROCARBURES.
 RENFORCEMENT : INSERTION TEXTILE HAUTE TENACITE.
 REVETEMENT : CAOUTCHOUC SYNTHETIQUE SPECIAL, RESISTANT A L'ABRASION, A L'OZONE, AUX HUILES ET AUX AGENTS ATMOSPHERIQUES.
 APPLICATION : POUR LE TRANSFER DE CARBURANT DANS LES MOTEURS A COMBUSTION INTERNE, POUR LA LUBRIFICATION ET LE GRAISSAGE.

ID		OD		WP		BP		W	L
inch	mm	mm		bar	psi	bar	psi	g/m	m

10 NL

1/4"	6	12	10	145	30	435	115	10-100
5/16"	8	14	10	145	30	435	145	10-100
3/8"	10	16	10	145	30	435	170	10-100
1/2"	13	20	10	145	30	435	265	10-100
5/8"	16	24	10	145	30	435	350	10-100
3/4"	19	27	10	145	30	435	400	10-100
1"	25	35	10	145	30	435	655	10-100

20 NL

1/4"	6	14	20	290	60	870	175	10-100
5/16"	8	17	20	290	60	870	245	10-100
3/8"	10	19	20	290	60	870	285	10-100
1/2"	13	22.5	20	290	60	870	380	10-100
5/8"	16	26	20	290	60	870	460	10-100
3/4"	19	30	20	290	60	870	590	10-100
1"	25	37	20	290	60	870	815	10-100



-35°C /+ 70°C
 -31°F /+ 158°F

MARKING / BESCHRIFTUNG / MARCATURA / MARQUAGE: **EMBOSSED OR INK JET**

SEL **TEXTOIL** **OIL HOSE - W.P. *** Bar (**** PSI) (** mm)**

NORMS NORMEN NORME NORMES	ISO 1307	COLOUR FARBEN COLORI COULEUR	
------------------------------------	----------	---------------------------------------	--

Oil



DIN 73379 Type B



TUBE : OIL AND FUEL RESISTANT NBR RUBBER.
 COVER : TEXTILE BRAID.
 APPLICATION : FOR DELIVERY OIL, FUEL OIL, GASOLINE ETC.



SEELE : ÖL-UND KRAFTSTOFFBESTÄNDIG, ISOLIEREND, NBR, SCHWARZ.
 DECKE : TEXTILGEFLECHT.
 ANWENDUNG : ZUR FÖRDERUNG VON ÖL UND KRAFTSTOFFEN IM KFZ-BEREICH.



SOTTOSTRATO : GOMMA SINTETICA NERA NBR, RESISTENTE ALL' OLIO ED AL GASOLIO.
 COPERTURA : TRECCIA TESSILE.
 IMPIEGO : MANDATA D'OLIO, BENZINA E DI GASOLIO.



TUBE : CAOUTCHOUC NBR, RESISTANT AUX HUILES ET AUX HYDROCARBURES.
 REVETEMENT : TRESSE TEXTILE.
 APPLICATION : POUR REFOULEMENT DES HUILES ET DES HYDROCARBURES.

ID		OD		WP		BP		BR/r	W	L
inch	mm	mm	mm	bar	psi	bar	psi	mm	g/m	m
-	3.2	7	7	10	145	30	435	40	38	+10
-	3.5	7.5	7.5	10	145	30	435	45	43	+10
-	4	8	8	10	145	30	435	45	46	+10
-	4	9	9	10	145	30	435	45	62	+10
-	4.5	9.5	9.5	10	145	30	435	50	70	+10
-	5	9	9	10	145	30	435	55	55	+10
-	5	10	10	10	145	30	435	55	76	+10
-	5.5	10.5	10.5	10	145	30	435	60	80	+10
-	6	11	11	10	145	30	435	60	90	+10
-	6	12	12	10	145	30	435	60	113	+10
-	6.5	11	11	10	145	30	435	60	81	+10
-	7	12	12	10	145	30	435	60	97	+10
-	7.5	12.5	12.5	10	145	30	435	70	101	+10
-	7.5	14.5	14.5	10	145	30	435	70	163	+10
-	8	13	13	10	145	30	435	80	113	+10
-	8	15	15	10	145	30	435	80	170	+10
-	9	15	15	10	145	30	435	80	147	+10
-	9.5	14.5	14.5	10	145	30	435	80	125	+10
-	10	15	15	10	145	30	435	80	132	+10
-	10	16	16	10	145	30	435	80	162	+10
-	10	17	17	10	145	30	435	80	204	+10
-	11	16	16	10	145	30	435	80	145	+10
-	11	17.5	17.5	10	145	30	435	80	198	+10
-	11	19	19	10	145	30	435	80	257	+10
-	12	17	17	10	145	30	435	100	149	+10
-	12	18	18	10	145	30	435	100	191	+10
-	12.5	19	19	10	145	30	435	100	217	+10
-	13	18	18	10	145	30	435	100	163	+10
-	14	22	22	10	145	30	435	100	316	+10
-	15	20	20	10	145	30	435	100	185	+10
-	16	23	23	10	145	30	435	-	272	+10
-	18	26	26	10	145	30	435	-	388	+10
-	19	27	27	10	145	30	435	-	395	+10



-30°C /+ 90°C
 -22°F /+194°F

MARKING / BESCHRIFTUNG / MARCATURA / MARQUAGE: **EMBOSSED OR INK JET**

SEL COTTON OIL-B DIN 73379 TYPE B - W.P. 10 Bar (145 PSI) (** mm)

NORMS NORMEN NORME NORMES	DIN 73379 TYPE B ISO 1307	COLOUR FARBEN COLORI COULEUR	
------------------------------------	------------------------------	---------------------------------------	--



Oil

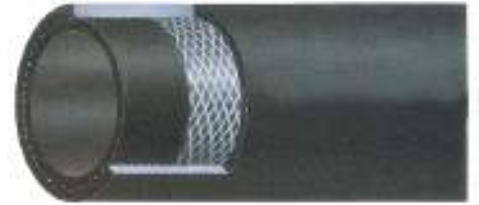

DIN 73379 Type 1A



TUBE : FUEL AND OIL RESISTANT, SMOOTH NBR RUBBER.
 REINFORCEMENT : HIGH TENSILE SYNTHETIC TEXTILE.
 COVER : ABRASION, FLAME, OZONE, WEATHER AND OIL RESISTANT SPECIAL SYNTHETIC RUBBER.
 APPLICATION : FOR DELIVERY OF FUELS IN INTERNAL COMBUSTION ENGINES FOR LUBRIFICATION AND GREASING SERVICES.



SEELE : KRAFTSTOFF- UND ÖLBESTÄNDIG, ISOLIEREND, NBR, GLATT.
 EINLAGE : HOCHZUGFESTE SYNTHETISCHE TEXTILEINLAGE.
 DECKE : ABRIEBFEST, ÖL-, OZON- UND WITTERUNGSBESTÄNDIG, SPEZIELLER SYNTHETIK GUMMI.
 ANWENDUNG : KRAFTSTOFFSCHLAUCH FÜR KRAFTFAHRZEUGE UND FETTPUMPEN.



SOTTOSTRATO : GOMMA NBR LISCIA NERA, RESISTENTE AGLI OLI ED AI CARBURANTI.
 RINFORZO : INSERZIONI TESSILI AD ALTA TENACITÀ.
 COPERTURA : GOMMA SPECIALE SINTETICA LISCIA NERA, RESISTENTE AGLI OLI, AI CARBURANTI, ALLA FIAMMA, ALL' ABRASIONE, ED AGLI AGENTI ATMOSFERICI.
 IMPIEGO : PER MANDATA DI CARBURANTI NEI MOTORI A COMBUSTIONE INTERNA O PER LUBRIFICAZIONE ED INGRASSAGGIO NEI VARI SERVIZI.



TUBE : CAOUTCHOUC NBR LISSE, RESISTANT AUX HUILES ET HYDROCARBURES.
 RENFORCEMENT : INSERTION TEXTILE HAUTE TENACITE.
 REVETEMENT : CAOUTCHOUC SYNTHETIQUE SPECIAL, RESISTANT A L'ABRASION, A LA FLAMME, A L'OZONE, AUX HUILES ET AUX AGENTS ATMOSPERIQUES.
 APPLICATION : POUR LE TRANSFER DE CARBURANT DANS LES MOTEURS A COMBUSTION INTERNE, POUR LA LUBRIFICATION ET LE GRAISSAGE.

ID		OD	WP		BP		BR/r	W	L
inch	mm	mm	bar	psi	bar	psi	mm	g/m	m
-	3,5	9,5	10	145	30	435	45	85	10-100
-	4	10	10	145	30	435	45	90	10-100
-	4,5	10,5	10	145	30	435	50	95	10-100
-	4,5	11,5	10	145	30	435	50	120	10-100
-	5	11	10	145	30	435	55	100	10-100
-	5	12	10	145	30	435	55	125	10-100
-	5,5	11,5	10	145	30	435	60	110	10-100
-	6	12	10	145	30	435	60	115	10-100
-	7	12	10	145	30	435	60	100	10-100
-	7	13	10	145	30	435	60	130	10-100
-	7,3	13,3	10	145	30	435	70	130	10-100
-	7,3	14,3	10	145	30	435	70	160	10-100
-	7,5	13,5	10	145	30	435	70	135	10-100
-	8	14	10	145	30	435	80	140	10-100
-	8	15	10	145	30	435	80	170	10-100
-	9	15	10	145	30	435	80	155	10-100
-	9,5	15,3	10	145	30	435	80	155	10-100
-	10	16	10	145	30	435	80	165	10-100
-	10	17	10	145	30	435	80	200	10-100
-	11	17	10	145	30	435	80	180	10-100
-	11	18	10	145	30	435	80	215	10-100
-	11,5	18,5	10	145	30	435	80	225	10-100
-	12,5	20	10	145	30	435	100	260	10-100
-	14	22	10	145	30	435	100	310	10-100
-	16	24	10	145	30	435	110	340	10-100



-30 °C / + 50 °C
 -22 °F / +122 °F

MARKING / BESCHRIFTUNG / MARCATURA / MARQUAGE: **EMBOSSED OR INK JET**

SEL OIL-1A DIN 73379 TYPE 1A - W.P. 10 Bar (145 PSI) (mm)**

NORMS
 NORMEN
 NORME
 NORMES

DIN 73379 TYPE 1A
 ISO 1307

COLOUR
 FARBEN
 COLORI
 COULEUR



Oil

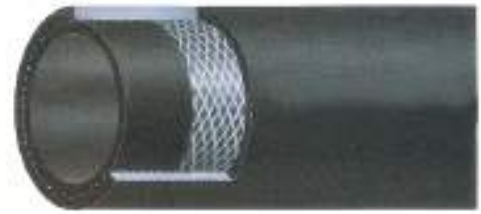

DIN 73379 Type 2A



TUBE : FUEL AND OIL RESISTANT, SMOOTH NBR RUBBER.
 REINFORCEMENT : HIGH TENSILE SYNTHETIC TEXTILE.
 COVER : ABRASION, FLAME, OZONE, WEATHER AND OIL RESISTANT SPECIAL CR RUBBER.
 APPLICATION : FOR DELIVERY OF FUELS IN INTERNAL COMBUSTION ENGINES FOR LUBRIFICATION AND GREASING SERVICES.



SEELE : KRAFTSTOFF- UND ÖLBESTÄNDIG, ISOLIEREND, NBR, GLATT.
 EINLAGE : HOCHZUGFESTE SYNTHETISCHE TEXTILEINLAGE.
 DECKE : ABRIEBFEST, ÖL-, OZON- UND WITTERUNGSBESTÄNDIG, SPEZIELLER CR GUMMI.
 ANWENDUNG : KRAFTSTOFFSCHLAUCH FÜR KRAFTFAHRZEUGE UND FETTPUMPEN.



SOTTOSTRATO : GOMMA NBR LISCIA NERA, RESISTENTE AGLI OLI ED AI CARBURANTI.
 RINFORZO : INSERZIONI TESSILI AD ALTA TENACITÀ.
 COPERTURA : GOMMA SPECIALE CR LISCIA NERA, RESISTENTE AGLI OLI, AI CARBURANTI, ALLA FIAMMA, ALL' ABRASIONE, ED AGLI AGENTI ATMOSFERICI.
 IMPIEGO : PER MANDATA DI CARBURANTI NEI MOTORI A COMBUSTIONE INTERNA O PER LUBRIFICAZIONE ED INGRASSAGGIO NEI VARI SERVIZI.



TUBE : CAOUTCHOUC NBR LISSE, RESISTANT AUX HUILES ET HYDROCARBURES.
 RENFORCEMENT : INSERTION TEXTILE HAUTE TENACITE.
 REVETEMENT : CAOUTCHOUC SPECIAL CR, RESISTANT A L'ABRASION, A LA FLAMME, A L'OZONE, AUX HUILES ET AUX AGENTS ATMOSPHERIQUES.
 APPLICATION : POUR LE TRANSFER DE CARBURANT DANS LES MOTEURS A COMBUSTION INTERNE, POUR LA LUBRIFICATION ET LE GRAISSAGE.

ID		OD		WP		BP		BR/r		W		L	
inch	mm	mm	mm	bar	psi	bar	psi	mm	g/m	m			
-	3.5	9.5	10	145	30	435	45	85	10-100				
-	4	10	10	145	30	435	45	90	10-100				
-	4.5	10.5	10	145	30	435	50	100	10-100				
-	4.5	11.5	10	145	30	435	50	120	10-100				
-	5	11	10	145	30	435	55	105	10-100				
-	5	12	10	145	30	435	55	130	10-100				
-	5.5	11.5	10	145	30	435	60	110	10-100				
-	6	12	10	145	30	435	60	115	10-100				
-	7	12	10	145	30	435	60	105	10-100				
-	7	13	10	145	30	435	60	130	10-100				
-	7.3	13.3	10	145	30	435	70	135	10-100				
-	7.3	14.3	10	145	30	435	70	165	10-100				
-	7.5	13.5	10	145	30	435	70	135	10-100				
-	8	14	10	145	30	435	80	145	10-100				
-	8	15	10	145	30	435	80	175	10-100				
-	9	15	10	145	30	435	80	155	10-100				
-	9.5	15.3	10	145	30	435	80	155	10-100				
-	10	16	10	145	30	435	80	170	10-100				
-	10	17	10	145	30	435	80	205	10-100				
-	11	17	10	145	30	435	80	185	10-100				
-	11	18	10	145	30	435	80	220	10-100				
-	11.5	18.5	10	145	30	435	80	230	10-100				
-	12.5	20	10	145	30	435	100	265	10-100				
-	14	22	10	145	30	435	100	315	10-100				
-	16	24	10	145	30	435	110	350	10-100				



-30°C /+ 90°C
 -22°F /+194°F

MARKING / BESCHRIFTUNG / MARCATURA / MARQUAGE: **EMBOSSED OR INK JET**

SEL OIL-2A **DIN 73379 TYPE 2A - W.P. 10 Bar (145 PSI) (** mm)**

NORMS NORMEN NORME NORMES	DIN 73379 TYPE 2A ISO 1307	COLOUR FARBEN COLORI COULEUR	
------------------------------------	-------------------------------	---------------------------------------	--



Oil

DIN 73379 Type 2B

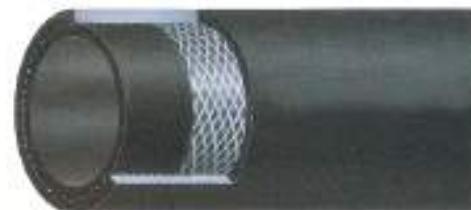

TUBE : FUEL AND OIL RESISTANT, SMOOTH NBR RUBBER.
 REINFORCEMENT : HIGH TENSILE SYNTHETIC TEXTILE.
 COVER : ABRASION, FLAME, OZONE, WEATHER AND OIL RESISTANT SPECIAL CSM RUBBER.
 APPLICATION : FOR DELIVERY OF FUELS IN INTERNAL COMBUSTION ENGINES FOR LUBRIFICATION AND GREASING SERVICES.



SEELE : KRAFTSTOFF- UND ÖLBESTÄNDIG, ISOLIEREND, NBR, GLATT.
 EINLAGE : HOCHZUGFESTE SYNTHETISCHE TEXTILEINLAGE.
 DECKE : ABRIEBFEST, ÖL-, OZON- UND WITTERUNGSBESTÄNDIG, SPEZIELLER CSM GUMMI.
 ANWENDUNG : KRAFTSTOFFSCHLAUCH FÜR KRAFTFAHRZEUGE UND FETTPUMPEN.



SOTTOSTRATO : GOMMA NBR LISCIA NERA, RESISTENTE AGLI OLI ED AI CARBURANTI.
 RINFORZO : INSERZIONI TESSILI AD ALTA TENACITÀ.
 COPERTURA : GOMMA SPECIALE CSM LISCIA NERA, RESISTENTE AGLI OLI, AI CARBURANTI, ALLA FIAMMA, ALL' ABRASIONE, ED AGLI AGENTI ATMOSFERICI.
 IMPIEGO : PER MANDATA DI CARBURANTI NEI MOTORI A COMBUSTIONE INTERNA O PER LUBRIFICAZIONE ED INGRASSAGGIO NEI VARI SERVIZI.



TUBE : CAOUTCHOUC NBR LISSE, RESISTANT AUX HUILES ET HYDROCARBURES.
 RENFORCEMENT : INSERTION TEXTILE HAUTE TENACITE.
 REVETEMENT : CAOUTCHOUC SPECIAL CSM, RESISTANT A L'ABRASION, A LA FLAMME, A L'OZONE, AUX HUILES ET AUX AGENTS ATMOSPHERIQUES.
 APPLICATION : POUR LE TRANSFER DE CARBURANT DANS LES MOTEURS A COMBUSTION INTERNE, POUR LA LUBRIFICATION ET LE GRAISSAGE.

ID		OD		WP		BP		BR/r	W	L
inch	mm	mm	mm	bar	psi	bar	psi	mm	g/m	m
-	3.5	9.5		10	145	30	435	45	86	10-100
-	4	10		10	145	30	435	45	92	10-100
-	4.5	10.5		10	145	30	435	50	99	10-100
-	4.5	11.5		10	145	30	435	50	122	10-100
-	5	11		10	145	30	435	55	105	10-100
-	5	12		10	145	30	435	55	130	10-100
-	5.5	11.5		10	145	30	435	60	111	10-100
-	6	12		10	145	30	435	60	118	10-100
-	7	12		10	145	30	435	60	104	10-100
-	7	13		10	145	30	435	60	132	10-100
-	7.3	13.3		10	145	30	435	70	136	10-100
-	7.3	14.3		10	145	30	435	70	165	10-100
-	7.5	13.5		10	145	30	435	70	138	10-100
-	8	14		10	145	30	435	80	144	10-100
-	8	15		10	145	30	435	80	176	10-100
-	9	15		10	145	30	435	80	158	10-100
-	9.5	15.3		10	145	30	435	80	162	10-100
-	10	16		10	145	30	435	80	172	10-100
-	10	17		10	145	30	435	80	207	10-100
-	11	17		10	145	30	435	80	185	10-100
-	11	18		10	145	30	435	80	223	10-100
-	11.5	18.5		10	145	30	435	80	231	10-100
-	12.5	20		10	145	30	435	100	267	10-100
-	14	22		10	145	30	435	100	315	10-100
-	16	24		10	145	30	435	110	350	10-100



-30°C /+ 90°C
 -22°F /+194°F

MARKING / BESCHRIFTUNG / MARCATURA / MARQUAGE: **EMBOSSED OR INK JET**

SEL OIL -2B DIN 73379 TYPE 2B - W.P. 10 Bar (145 PSI) (mm)**

NORMS NORMEN NORME NORMES	DIN 73379 TYPE 2B ISO 1307	COLOUR FARBEN COLORI COULEUR	
------------------------------------	-------------------------------	---------------------------------------	--

Galvanized Wire Braided Oil









 **TUBE** : OIL AND FUEL RESISTANT NBR RUBBER.
COVER : GALVANIZED WIRE BRAID.
APPLICATION : FOR DELIVERY OF TRANSMISSION OIL, FUEL OIL, GASOLINE, ETC.

 **SEELE** : ÖL-UND KRAFTSTOFFBESTÄNDIG, NBR-GUMMI.
DECKE : MIT VERZINKTEM STAHLDRAHTGEFLECHT.
ANWENDUNG : ZUM DURCHLEITEN VON KRAFTSTOFFEN WIE ÖL, GAS, HEIZÖL ETC.

 **SOTTOSTRATO** : GOMMA SINTETICA NBR, RESISTENTE AI PRODOTTI PETROLIFERI.
COPERTURA : TRECCIA ZINCATO.
IMPIEGO : PER MANDATA D'OLIO, BENZINA, GASOLIO E DI LUBRIFICANTI ETC.

 **TUBE** : CAOUTCHOUC NBR, RESISTANT AUX HUILES ET HYDROCARBURES.
REVETEMENT : TRESSE GALVANISEE.
APPLICATION : POUR REFOULEMENT DES HUILES ET DES HYDROCARBURES.

 ID mm	 OD mm	 WP		 BP		 W g/m	 L m
		bar	psi	bar	psi		
5	10	25	365	75	1088	80	100
6	11	25	365	75	1088	90	100
8	13	25	365	75	1088	115	100
9	14	25	365	75	1088	125	100
10	15	25	365	75	1088	135	100
13	19	20	290	60	870	185	100
16	22	20	290	60	870	290	50
19	25	15	218	45	653	330	50
25	33	15	218	45	653	500	50



-35°C /+ 90°C
 -31°F /+194°F

NORMS
 NORMEN
 NORME
 NORMES

ISO 1307

COLOUR
 FARBEN
 COLORI
 COULEUR



Petroleum Dispensing

Tankstellenzapfschläuch

Distribuzione del Carburante

Distribution Carburant



Petrol Pump

-40 °C



TUBE : OIL, GASOLINE AND DIESEL RESISTANT SMOOTH, BLACK, NITRILE RUBBER.
 REINFORCEMENT : HIGH TENSILE SYNTHETIC TEXTILE AND ANTISTATIC COPPER WIRE.
 COVER : FLAME, OIL, FUEL, ABRASION, OZONE, HEAT AND WEATHER RESISTANT, SYNTHETIC RUBBER.
 APPLICATION : FOR ALL TYPES OF GASOLINE DISPENSING APPLICATIONS. (REGULAR, PREMIUM GASOLINE AND DIESEL).



SEELE : ÖL-, DIESEL- UND KRAFTSTOFFBESTÄNDIG, GLATT, SCHWARZ, NITRILGUMMI.
 EINLAGE : HOCHZUGFESTE SYNTHETISCHE TEXTILEINLAGE MIT ANTISTATISCHER KUPFERLITZE.
 DECKE : ABRIEB-, HITZE-, ÖL- UND WITTERUNGBESTÄNDIGER, FLAMMWIDRIGER, SPEZIELLER SYNTHETIKGUMMI.
 ANWENDUNG : FÜR TANKSTELLEN ZUM FÖRDERN VON VERSCHIEDENEN ÖLPRODUKTEN (ANWENDUNGEN MIT NORMALEN UND HOCHWERTIGEN KRAFTSTOFFEN UND DIESEL).



SOTTOSTRATO : GOMMA NITRILICA NERA, RESISTENTE AI PRODOTTI PETROLIFERI.
 RINFORZO : INSERZIONI TESSILI AD ALTA TENACITÀ E CORDICELLA DI RAME ANTISTATICA.
 COPERTURA : GOMMA SPECIALE RESISTENTE AGLI OLI, ALLA FIAMMA, ALL'OZONO , ALL 'ABRASIONE ET AGLI AGENTI ATMOSFERICI.
 IMPIEGO : EROGAZIONE DI CARBURANTI NELLE STAZIONI DI SERVIZIO (BENZINA, BENZINA VERDE, GASOLIO).



TUBE : CAOUTCHOUC NITRILE, NOIR LISSE RESISTANT AUX HUILES, A L'ESSENCE, AU GAZ-OIL.
 RENFORCEMENT : INSERTION TEXTILE HAUTE TENACITE ET FIL DE MASSE ANTISTATIQUE.
 REVETEMENT : CAOUTCHOUC SYNTHETIQUE, RESISTANT A LA FLAMME, AUX HUILES, A L'ESSENCE, A L'ABRASION, A L'OZONE, A LA CHALEUR ET AUX AGENTS ATMOSPHERIQUES.
 APPLICATION : POUR LES EQUIPEMENTS DES POMPES A ESSENCES POUR LA DISTRIBUTION VOLUMETRIQUE DE CARBURANT. (ESSENCE ORDINAIRE, SUPER, SANS PLOMB ET GAZ-OIL).

ID		OD		WP		BP		BR/r	W	L
inch	mm	mm	mm	bar	psi	bar	psi	mm	g/m	m
1/2"	12.7	21.5	16	232	48	696	60	295	>6	
5/8"	16	26	16	232	48	696	80	425	>6	
3/4"	19	29	16	232	48	696	100	475	>6	
1"	25.4	36.5	16	232	48	696	150	690	>6	

OPTIONS / OPTIONEN / OPZIONI / OPTIONS

- Tube upon request : Conductive (Ω)
- Seele nach Anfrage : Leitfähig (Ω)
- Sottostrato su richiesta : Conduttiva (Ω)
- Tube sur demande : Conducteur (Ω)



-40°C / + 55°C
 -40°F / +131°F



MARKING / BESCHRIFTUNG / MARCATURA / MARQUAGE: **EMBOSSED, INK JET OR TRANSFER TAPE**

SEL POMPA/L PETROL PUMP HOSE - TS EN 1360 - Type 1 - M - NT - W.P. 16 BAR (232 PSI)

NORMS NORMEN NORME NORMES	TS EN 1360 TYPE 1 ISO 1307	COLOUR FARBEN COLORI COULEUR	
------------------------------------	-------------------------------	---------------------------------------	--



Petrol Pump



TUBE : OIL, GASOLINE AND DIESEL RESISTANT SMOOTH, BLACK, NITRILE RUBBER.
 REINFORCEMENT : HIGH TENSILE SYNTHETIC TEXTILE AND ANTISTATIC COPPER WIRE.
 COVER : FLAME, OIL, FUEL, ABRASION, OZONE, HEAT AND WEATHER RESISTANT, SYNTHETIC RUBBER.
 APPLICATION : FOR ALL TYPES OF GASOLINE DISPENSING APPLICATIONS. (REGULAR, PREMIUM GASOLINE AND DIESEL).



SEELE : ÖL-, DIESEL- UND KRAFTSTOFFBESTÄNDIG, GLATT, SCHWARZ, NITRILGUMMI.
 EINLAGE : HOCHZUGFESTE SYNTHETISCHE TEXTILEINLAGE MIT ANTISTATISCHER KUPFERLITZE.
 DECKE : ABRIEB-, HITZE-, ÖL- UND WITTERUNGBESTÄNDIGER, FLAMMWIDRIGER, SPEZIELLER SYNTHETIKGUMMI.
 ANWENDUNG : FÜR TANKSTELLEN ZUM FÖRDERN VON VERSCHIEDENEN ÖLPRODUKTEN (ANWENDUNGEN MIT NORMALEN UND HOCHWERTIGEN KRAFTSTOFFEN UND DIESEL).



SOTTOSTRATO : GOMMA NITRILICA NERA, RESISTENTE AI PRODOTTI PETROLIFERI.
 RINFORZO : INSERZIONI TESSILI AD ALTA TENACITÀ E CORDICELLA DI RAME ANTISTATICA.
 COPERTURA : GOMMA SPECIALE RESISTENTE AGLI OLI, ALLA FIAMMA, ALL'OZONO, ALL' ABRASIONE ET AGLI AGENTI ATMOSFERICI.
 IMPIEGO : EROGAZIONE DI CARBURANTI NELLE STAZIONI DI SERVIZIO (BENZINA, BENZINA VERDE, GASOLIO)



TUBE : CAOUTCHOUC NITRILE, NOIR LISSE RESISTANT AUX HUILES, A L'ESSENCE, AU GAZ-OIL.
 RENFORCEMENT : INSERTION TEXTILE HAUTE TENACITE ET FIL DE MASSE ANTISTATIQUE.
 REVETEMENT : CAOUTCHOUC SYNTHETIQUE, RESISTANT A LA FLAMME, AUX HUILES, A L'ESSENCE, A L'ABRASION, A L'OZONE, A LA CHALEUR ET AUX AGENTS ATMOSPHERIQUES.
 APPLICATION : POUR LES EQUIPEMENTS DES POMPES A ESSENCES POUR LA DISTRIBUTION VOLUMETRIQUE DE CARBURANT. (ESSENCE ORDINAIRE, SUPER, SANS PLOMB ET GAZ-OIL).

ID		OD	BR/r	W	L
inch	mm	mm	mm	g/m	m
1/2"	12.7	21.5	89	330	>6
5/8"	16	25.4	89	430	>6
3/4"	19	28.6	89	490	>6
1"	25.4	34.9	89	625	>6

* Tested for -54°C in accordance with UL 330.



-40°C / + 85°C
 -40°F / +185°F



MARKING / BESCHRIFTUNG / MARCATURA / MARQUAGE: **EMBOSSED, INK JET OR TRANSFER TAPE**

SEL LISTED - MH45766 - 3JYR - (**mm) TYPE 1 GASOLINE HOSE EXCEEDS -54 °C (QUARTER / YEAR) 100108-328 (LOT)

NORMS NORMEN NORME NORMES	UL 330 ISO 1307	COLOUR FARBEN COLORI COULEUR	
------------------------------------	--------------------	---------------------------------------	--

Petrol Pump Steel Wire Braided

-40 °C



TUBE : OIL, GASOLINE AND DIESEL RESISTANT SMOOTH, BLACK, NITRILE RUBBER.
 REINFORCEMENT : 1 HIGH TENSILE STEEL WIRE BRAID.
 COVER : FLAME, OIL, FUEL, ABRASION, OZONE, HEAT AND WEATHER RESISTANT, SYNTHETIC RUBBER.
 APPLICATION : FOR ALL TYPES OF GASOLINE DISPENSING APPLICATIONS. (REGULAR, PREMIUM GASOLINE AND DIESEL).



SEELE : ÖL-, DIESEL- UND KRAFTSTOFFBESTÄNDIG, GLATT, SCHWARZ, NITRILGUMMI.
 EINLAGE : HOCHZUGFESTES, EINLAGIGES STAHLDRAHTGEFLECHT.
 DECKE : ABRIEB-, HITZE-, ÖL- UND WITTERUNGBESTÄNDIGER, FLAMMWIDRIGER, SPEZIELLER SYNTHETIKGUMMI.
 ANWENDUNG : FÜR TANKSTELLEN ZUM FÖRDERN VON VERSCHIEDENEN ÖLPRODUKTEN (ANWENDUNGEN MIT NORMALEN UND HOCHWERTIGEN KRAFTSTOFFEN UND DIESEL).



SOTTOSTRATO : GOMMA NITRILICA NERA, RESISTENTE AI PRODOTTI PETROLIFERI.
 RINFORZO : 1 TRECCA IN ACCIAIO AD ALTA TENACITÀ
 COPERTURA : GOMMA SPECIALE RESISTENTE AGLI OLI, ALLA FIAMMA, ALL'OZONO, ALL'ABRASIONE ET AGLI AGENTI ATMOSFERICI.
 IMPIEGO : EROGAZIONE DI CARBURANTI NELLE STAZIONI DI SERVIZIO (BENZINA, BENZINA VERDE, GASOLIO).



TUBE : CAOUTCHOUC NITRILE, NOIR LISSE RESISTANT AUX HUILES, A L'ESSENCE, AU GAZ-OIL.
 RENFORCEMENT : 1 TRESSE D'ACIER TRES RESISTANTE.
 REVETEMENT : CAOUTCHOUC SYNTHETIQUE, RESISTANT A LA FLAMME, AUX HUILES, A L'ESSENCE, A L'ABRASION, A L'OZONE, A LA CHALEUR ET AUX AGENTS ATMOSPHERIQUES.
 APPLICATION : POUR LES EQUIPEMENTS DES POMPES A ESSENCES POUR LA DISTRIBUTION VOLUMETRIQUE DE CARBURANT. (ESSENCE ORDINAIRE, SUPER, SANS PLOMB ET GAZ-OIL).

ID		OD		WP		BP		BR/r		W		L	
inch	mm	mm	mm	bar	psi	bar	psi	mm	g/m	m			
1/2"	12.7	21.5	16	232	48	696	60	385	>6				
5/8"	16	26	16	232	48	696	80	525	>6				
3/4"	19	29	16	232	48	696	100	595	>6				
1"	25.4	36.5	16	232	48	696	150	860	>6				

OPTIONS / OPTIONEN / OPZIONI / OPTIONS

Tube upon request : Conductive (Ω)
 Seele nach Anfrage : Leitfähig (Ω)
 Sottostrato su richiesta : Conduttiva (Ω)
 Tube sur demande : Conducteur (Ω)



-30°C / + 55°C (OPTIONAL -40°C /+ 55°C)
 -22°F / +131°F (OPTIONAL -40°F /+ 131°F)

MARKING / BESCHRIFTUNG / MARCATURA / MARQUAGE: **EMBOSSED, INK JET OR TRANSFER TAPE**

SEL POMPA SWB PETROL PUMP HOSE - TS EN 1360 - Type 3 - M - NT - W.P. 16 BAR (232 PSI)

NORMS NORMEN NORME NORMES	TS EN 1360 TYPE 3 ISO 1307	COLOUR FARBEN COLORI COULEUR	
------------------------------------	-------------------------------	---------------------------------------	--

Petrol Pump Steel Wire Braided



TUBE : OIL, GASOLINE AND DIESEL RESISTANT SMOOTH, BLACK, NITRILE RUBBER.
 REINFORCEMENT : 1 HIGH TENSILE STEEL WIRE BRAID.
 COVER : FLAME, OIL, FUEL, ABRASION, OZONE, HEAT AND WEATHER RESISTANT, SYNTHETIC RUBBER.
 APPLICATION : FOR ALL TYPES OF GASOLINE DISPENSING APPLICATIONS. (REGULAR, PREMIUM GASOLINE AND DIESEL).



SEELE : ÖL-, DIESEL- UND KRAFTSTOFFBESTÄNDIG, GLATT, SCHWARZ, NITRILGUMMI.
 EINLAGE : HOCHZUGFESTES, EINLAGIGES STAHLDRAHTEGFLICHT.
 DECKE : ABRIEB-, HITZE-, ÖL- UND WITTERUNGBESTÄNDIGER, FLAMMWIDRIGER, SPEZIELLER SYNTHETIKGUMMI.
 ANWENDUNG : FÜR TANKSTELLEN ZUM FÖRDERN VON VERSCHIEDENEN ÖLPRODUKTEN (ANWENDUNGEN MIT NORMALEN UND HOCHWERTIGEN KRAFTSTOFFEN UND DIESEL).



SOTTOSTRATO : GOMMA NITRILICA NERA, RESISTENTE AI PRODOTTI PETROLIFERI.
 RINFORZO : 1 TRECCA IN ACCIAIO AD ALTA TENACITÀ.
 COPERTURA : GOMMA SPECIALE RESISTENTE AGLI OLI, ALLA FIAMMA, ALL'OZONO, ALL' ABRASIONE ET AGLI AGENTI ATMOSFERICI.
 IMPIEGO : EROGAZIONE DI CARBURANTI NELLE STAZIONI DI SERVIZIO (BENZINA, BENZINA VERDE, GASOLIO).



TUBE : CAOUTCHOUC NITRILE, NOIR LISSE RESISTANT AUX HUILES, A L'ESSENCE AU GAZ-OIL.
 REINFORCEMENT : 1 TRESSE D'ACIER TRES RESISTANTE.
 REVETEMENT : CAOUTCHOUC SYNTHETIQUE, RESISTANT A LA FLAMME, AUX HUILES, A L'ESSENCE, A L'ABRASION, A L'OZONE, A LA CHALEUR ET AUX AGENTS ATMOSPHERIQUES.
 APPLICATION : POUR LES EQUIPEMENTS DES POMPES A ESSENCES POUR LA DISTRIBUTION VOLUMETRIQUE DE CARBURANT. (ESSENCE ORDINAIRE, SUPER, SANS PLOMB ET GAZ-OIL).

ID		OD	BR/r	W	L
inch	mm	mm	mm	g/m	m
1/2"	12.7	21.5	89	470	>6
5/8"	16	25.4	89	575	>6
3/4"	19	28.6	89	655	>6
1"	25.4	34.9	89	815	>6

* Tested for -54°C in accordance with UL 330.



-40°C / + 85°C
 -40°F / +185°F



MARKING / BESCHRIFTUNG / MARCATURA / MARQUAGE: **EMBOSSED, INK JET OR TRANSFER TAPE**

SEL LISTED - MH45766 - 3JYR - (**mm) TYPE 3 GASOLINE HOSE EXCEEDS -54 ° C (QUARTER / YEAR) 100108-328 (LOT)

NORMS NORMEN NORME NORMES	UL 330 ISO 1307	COLOUR FARBEN COLORI COULEUR	
------------------------------------	--------------------	---------------------------------------	--

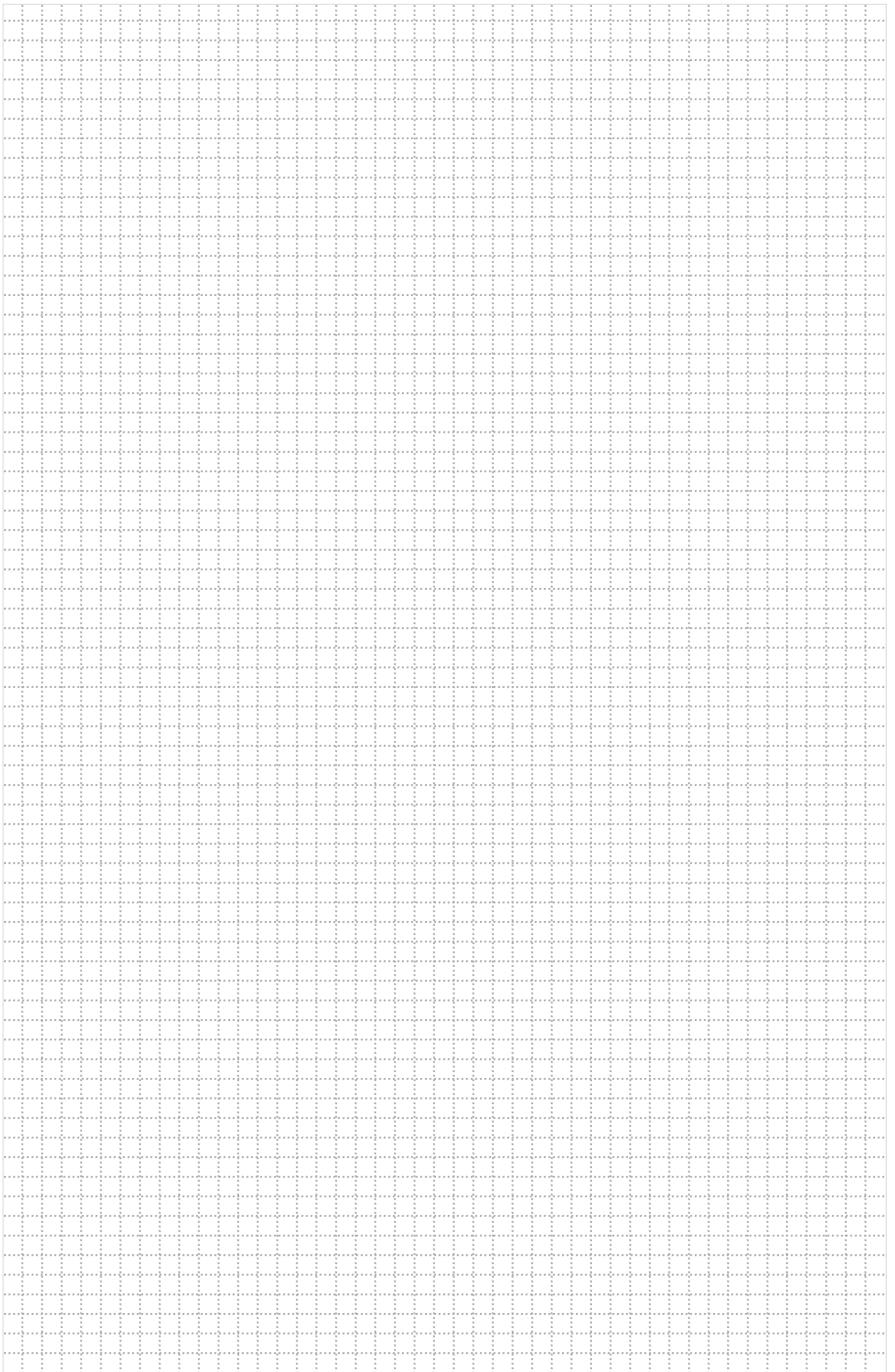

Chemical

Chemie

Prodotti Chimici

Produits Chimiques



Chemical Delivery EPDM



TUBE : CHEMICAL RESISTANT BLACK EPDM RUBBER.
 REINFORCEMENT : HIGH TENSILE SYNTHETIC TEXTILE AND ANTISTATIC COPPER WIRE.
 COVER : WEATHER, OZONE AND ABRASION RESISTANT EPDM RUBBER.
 APPLICATION : FOR DISCHARGE WIDE RANGE OF CHEMICALS (SEE SEL CHEMICAL RESISTANCE CHART), SEA AND INDUSTRIAL WATER.



SEELE : BESTÄNDIG GEGEN CHEMIKALIEN, SCHWARZ, EPDM
 EINLAGE : HOCHZUGFESTE SYNTHETISCHE TEXTILEINLAGE UND ANTISTATISCHER KUPFERLITZE
 DECKE : OZON- UND WITTERUNGSBESTÄNDIGER, ABRIEBSFESTER EPDM GUMMI
 ANWENDUNG : DRUCKSCHLAUCH GEEIGNET FÜR VIELE CHEMIKALIEN (SIEHE SEL BESTÄNDIGKEITSLISTE) MEER- UND INDUSTRIEWASSER



SOTTOSTRATO : GOMMA EPDM NERA RESISTENTE AGLI ACIDI ED AI PRODOTTI CHIMICI.
 RINFORZO : INSERZIONI TESSILI AD ALTA TENACITÀ CON CORDICELLA DI RAME ANTISTATICA.
 COPERTURA : GOMMA EPDM RESISTENTE ALL'ABRASIONE, ALL'OZONO ED AGLI AGENTI ATMOSFERICI.
 IMPIEGO : PER MANDATA DI PRODOTTI CHIMICI (VEDERE LA TABELLA SEL DELLA RESISTENZA CHIMICA), ACQUA DI MARE ED INDUSTRIALE.



TUBE : CAOUTCHOUC EPDM NOIR RESISTANT AUX PRODUITS CHIMIQUES.
 RENFORCEMENT : INSERTION TEXTILE HAUTE TENACITE ET FIL DE MASSE ANTISTATIQUE.
 REVETEMENT : CAOUTCHOUC EPDM, RESISTANT A L'ABRASION, A L'OZONE ET AUX AGENTS ATMOSPHERIQUES.
 APPLICATION : POUR REFOULEMENT DE PRODUITS CHIMIQUES (VOIR LE TABLEAU DE RESISTANCE CHIMIQUE SEL), EAU DE MER ET INDUSTRIELLE.

ID		OD	WP		BP		W	L
inch	mm	mm	bar	psi	bar	psi	g/m	m
3/4"	19	29	10	145	40	580	475	40-46-61
1"	25.4	35	10	145	40	580	600	40-46-61
1 1/4"	32	43	10	145	40	580	855	40-46-61
1 1/2"	38	49	10	145	40	580	985	40-46-61
1 3/4"	44.5	56	10	145	40	580	1180	40-46-61
2"	50.8	64	10	145	40	580	1545	40-46-61
2 1/2"	63.5	77	10	145	40	580	1905	40-46-61
2 3/4"	70	84	10	145	40	580	2190	40-46-61
3"	76.2	90	10	145	40	580	2365	40-46-61
4"	101.6	116	10	145	40	580	3110	40-46-61

IMPORTANT : When ordering: Clearly specify working conditions such as characteristics of fluid, concentration and working temperature. Other diameters, pressures, colours, cover type and double steel wire helix can be made upon request.

WICHTIG : Bei Aufträgen bitte Material, Konzentrat und Betriebsdruck genau angeben. Weitere Sonderwünsche wie besondere Abmessungen, Aufdrucktypen, Farben, Aussengummi und Doppelspirale auf Anfrage möglich.

IMPORTANTE : In sede d'ordine specificare: Caratteristiche del fluido, della concentrazione e della temperatura d'esercizio. Altri diametri, pressioni, colori, tipo di copertura e doppio spirale d'acciaio realizzabili su richiesta.

IMPORTANT : Mentionner avec la commande les caracteristiques de la matiere, la concentration et la pression de service. Les autres diametres, pressions, couleurs, type de revetement et double helice acier peuvent etre produits selon la commande.



-40°C / +120°C
 -40°F / +248°F

MARKING / BESCHRIFTUNG / MARCATURA / MARQUAGE: **TRANSFER TAPE OR EMBOSSED**



NORMS NORMEN NORME NORMES	ISO 1307	COLOUR FARBEN COLORI COULEUR	
------------------------------------	----------	---------------------------------------	--



Chemical S&D EPDM



TUBE : CHEMICAL RESISTANT BLACK EPDM RUBBER.
 REINFORCEMENT : HIGH TENSILE SYNTHETIC TEXTILE, STEEL WIRE HELIX AND ANTISTATIC COPPER WIRE.
 COVER : WEATHER, OZONE AND ABRASION RESISTANT EPDM RUBBER.
 APPLICATION : FOR SUCTION AND DISCHARGE WIDE RANGE OF CHEMICALS (SEE SEL CHEMICAL RESISTANCE CHART), SEA AND INDUSTRIAL WATER.



SEELE : BESTÄNDIG GEGEN CHEMIKALIEN, SCHWARZ, EPDM.
 EINLAGE : HOCHZUGFESTE SYNTHETISCHE TEXTILEINLAGE MIT EINER STAHLDRAHTSPIRALE UND ANTISTATISCHER KUPFERLITZE.
 DECKE : OZON- UND WITTERUNGSBESTÄNDIGER, ABRIEBSFESTER EPDM GUMMI.
 ANWENDUNG : SAUG- DRUCKSCHLAUCH GEEIGNET FÜR VIELE CHEMIKALIEN (SIEHE SEL BESTÄNDIGKEITSLISTE) MEER- UND INDUSTRIEWASSER.



SOTTOSTRATO : GOMMA EPDM NERA RESISTENTE AGLI ACIDI ED AI PRODOTTI CHIMICI.
 RINFORZO : INSERZIONI TESSILI AD ALTA TENACITÀ, CON SPIRALE D'ACCIAIO E CORDICELLA DI RAME ANTISTATICA.
 COPERTURA : GOMMA EPDM RESISTENTE ALL'ABRASIONE, ALL'OZONO ED AGLI AGENTI ATMOSFERICI.
 IMPIEGO : PER ASPIRAZIONE E MANDATA DI PRODOTTI CHIMICI (VEDERE LA TABELLA SEL DELLA RESISTENZA CHIMICA), ACQUA DI MARE ED INDUSTRIALE



TUBE : CAOUTCHOUC EPDM NOIR RESISTANT AUX PRODUITS CHIMIQUES.
 RENFORCEMENT : INSERTION TEXTILE HAUTE TENACITE, SPIRALE EN ACIER ET FIL DE MASSE ANTISTATIQUE.
 REVETEMENT : CAOUTCHOUC EPDM, RESISTANT A L'ABRASION, A L'OZONE ET AUX AGENTS ATMOSPHERIQUES.
 APPLICATION : POUR ASPIRATION ET REFOULEMENT DE PRODUITS CHIMIQUES (VOIR LE TABLEAU DE RESISTANCE CHIMIQUE SEL), EAU DE MER ET INDUSTRIELLE.

ID		OD		WP		BP		VACUUM	BR/r	W	L
inch	mm	mm	mm	bar	psi	bar	psi	bar	mm	g/m	m
3/4"	19	30	30	10	145	40	580	-0.92	75	605	40-46-61
1"	25.4	36	36	10	145	40	580	-0.92	100	720	40-46-61
1 1/4"	32	44	44	10	145	40	580	-0.92	125	1020	40-46-61
1 1/2"	38	51	51	10	145	40	580	-0.92	150	1355	40-46-61
1 3/4"	44.5	58	58	10	145	40	580	-0.92	190	1625	40-46-61
2"	50.8	66	66	10	145	40	580	-0.92	225	2080	40-46-61
2 1/2"	63.5	79	79	10	145	40	580	-0.92	280	2700	40-46-61
2 3/4"	70	86	86	10	145	40	580	-0.92	315	3005	40-46-61
3"	76.2	92	92	10	145	40	580	-0.92	340	3240	40-46-61
4"	101.6	118	118	10	145	40	580	-0.92	455	4050	40-46-61

IMPORTANT : When ordering: Clearly specify working conditions such as characteristics of fluid, concentration and working temperature.
 Other diameters, pressures, colours, cover type and double steel wire helix can be made upon request.

WICHTIG : Bei Aufträgen bitte Material, Konzentrat und Betriebsdruck genau angeben. Weitere Sonderwünsche wie besondere Abmessungen, Aufdrucktypen, Farben, Aussengummi und Doppelspirale auf Anfrage möglich.

IMPORTANTE : In sede d'ordine specificare: Caratteristiche del fluido, della concentrazione e della temperatura d'esercizio.
 Altri diametri, pressioni, colori, tipo di copertura e doppio spirale d'acciaio realizzabili su richiesta.

IMPORTANT : Mentionner avec la commande les caracteristiques de la matiere, la concentration et la pression de service.
 Les autres diametres, pressions, couleurs, type de revetement et double helice acier peuvent etre produits selon la commande.



-40°C / + 120°C
 -40°F / + 248°F

MARKING / BESCHRIFTUNG / MARCATURA / MARQUAGE: **TRANSFER TAPE OR EMBOSSED**



NORMS NORMEN NORME NORMES	ISO 1307	COLOUR FARBEN COLORI COULEUR	
------------------------------------	----------	---------------------------------------	--

Chemical S&D EPDM

CORRUGATED



TUBE : CHEMICAL RESISTANT BLACK EPDM RUBBER.
 REINFORCEMENT : HIGH TENSILE SYNTHETIC TEXTILE, STEEL WIRE HELIX AND ANTISTATIC COPPER WIRE.
 COVER : OZON- UND WITTERUNGSBESTÄNDIGER, ABRIEBSFESTER EPDM GUMMI, GEWELLT.
 APPLICATION : FOR SUCTION AND DISCHARGE WIDE RANGE OF CHEMICALS (SEE SEL CHEMICAL RESISTANCE CHART), SEA AND INDUSTRIAL WATER.



SEELE : BESTÄNDIG GEGEN CHEMIKALIEN, SCHWARZ, EPDM.
 EINLAGE : HOCHZUGFESTE SYNTHETISCHE TEXTILEINLAGE MIT EINER STAHLDRAHTSPIRALE UND ANTISTATISCHER KUPFERLITZE.
 DECKE : OZON- UND WITTERUNGSBESTÄNDIGER, ABRIEBSFESTER EPDM GUMMI, GEWELLT.
 ANWENDUNG : SAUG - DRUCKSCHLAUCH GEEIGNET FÜR VIELE CHEMIKALIEN (SIEHE SEL BESTÄNDIGKEITSLISTE) MEER- UND INDUSTRIEWASSER.



SOTTOSTRATO : GOMMA EPDM NERA RESISTENTE AGLI ACIDI ED AI PRODOTTI CHIMICI.
 RINFORZO : INSERZIONI TESSILI AD ALTA TENACITÀ, CON SPIRALE D'ACCIAIO E CORDICELLA DI RAME ANTISTATICA.
 COPERTURA : GOMMA EPDM ONDULATO RESISTENTE ALL'ABRASIONE, ALL'OZONO ED AGLI AGENTI ATMOSFERICI.
 IMPIEGO : PER ASPIRAZIONE E MANDATA DI PRODOTTI CHIMICI (VEDERE LA TABELLA SEL DELLA RESISTENZA CHIMICA), ACQUA DI MARE ED INDUSTRIALE.



TUBE : CAOUTCHOUC EPDM NOIR RESISTANT AUX PRODUITS CHIMIQUES.
 RENFORCEMENT : INSERTION TEXTILE HAUTE TENACITE, SPIRALE EN ACIER ET FIL DE MASSE ANTISTATIQUE.
 REVETEMENT : CAOUTCHOUC EPDM ONDULE, RESISTANT A L'ABRASION, A L'OZONE ET AUX AGENTS ATMOSPHERIQUES.
 APPLICATION : POUR ASPIRATION ET REFOULEMENT DE PRODUITS CHIMIQUES (VOIR LE TABLEAU DE RESISTANCE CHIMIQUE SEL), EAU DE MER ET INDUSTRIELLE.

ID		OD		WP		BP		VACUUM	BR/r	W	L
inch	mm	mm	mm	bar	psi	bar	psi	bar	mm	g/m	m
3/4"	19	29.5	10	145	40	580	-0.92	75	612	40-46-61	
1"	25.4	36	10	145	40	580	-0.92	100	761	40-46-61	
1 1/4"	32	43	10	145	40	580	-0.92	125	995	40-46-61	
1 1/2"	38	49	10	145	40	580	-0.92	150	1153	40-46-61	
1 3/4"	44.5	56.5	10	145	40	580	-0.92	190	1410	40-46-61	
2"	50.8	63	10	145	40	580	-0.92	240	1727	40-46-61	
2 1/2"	63.5	77	10	145	40	580	-0.92	305	2470	40-46-61	
2 3/4"	70	83.5	10	145	40	580	-0.92	335	2697	40-46-61	
3"	76.2	92.5	10	145	40	580	-0.92	380	3400	40-46-61	
4"	101.6	118	10	145	40	580	-0.92	525	4418	40-46-61	

IMPORTANT : When ordering: Clearly specify working conditions such as characteristics of fluid, concentration and working temperature.
 Other diameters, pressures, colours, cover type and double steel wire helix can be made upon request.

WICHTIG : Bei Aufträgen bitte Material, Konzentrat und Betriebsdruck genau angeben. Weitere Sonderwünsche wie besondere Abmessungen, Aufdrucktypen, Farben, Aussengummi und Doppelspirale auf Anfrage möglich.

IMPORTANTE : In sede d'ordine specificare: Caratteristiche del fluido, della concentrazione e della temperatura d'esercizio.
 Altri diametri, pressioni, colori, tipo di copertura e doppio spirale d'acciaio realizzabili su richiesta.

IMPORTANT : Mentionner avec la commande les caracteristiques de la matiere, la concentration et la pression de service.
 Les autres diametres, pressions, couleurs, type de revetement et double helice acier peuvent etre produits selon la commande.



-40°C / +120°C
 -40°F / +248°F

MARKING / BESCHRIFTUNG / MARCATURA / MARQUAGE: **TRANSFER TAPE OR EMBOSSED**



NORMS NORMEN NORME NORMES	ISO 1307	COLOUR FARBEN COLORI COULEUR	
------------------------------------	----------	---------------------------------------	--



Chemical Delivery EPDM

EN 12115



TUBE : CHEMICAL RESISTANT BLACK EPDM RUBBER.
 REINFORCEMENT : HIGH TENSILE SYNTHETIC TEXTILE AND 2 ANTISTATIC COPPER WIRES.
 COVER : WEATHER, OZONE, FLAME AND ABRASION RESISTANT CR RUBBER.
 APPLICATION : FOR DISCHARGE WIDE RANGE OF CHEMICALS (SEE SEL CHEMICAL RESISTANCE CHART), SEA AND INDUSTRIAL WATER.



SEELE : BESTÄNDIG GEGEN CHEMIKALIEN, SCHWARZ, EPDM.
 EINLAGE : HOCHZUGFESTE SYNTHETISCHE TEXTILEINLAGE MIT 2 ANTISTATISCHE KUPFERLITZEN.
 DECKE : OZON- UND WITTERUNGSBESTÄNDIGER, ABRIEBSFESTER, FLAMMWIDRIGER CR GUMMI.
 ANWENDUNG : DRUCKSCHLAUCH GEEIGNET FÜR VIELE CHEMIKALIEN (SIEHE SEL BESTÄNDIGKEITSLISTE) MEER- UND INDUSTRIEWASSER.



SOTTOSTRATO : GOMMA EPDM NERA RESISTENTE AGLI ACIDI ED AI PRODOTTI CHIMICI.
 RINFORZO : INSERZIONI TESSILI AD ALTA TENACITÀ CON 2 CORDICELLE DI RAME ANTISTATICHE.
 COPERTURA : GOMMA CR RESISTENTE ALL'ABRASIONE, ALL'OZONO, ALLA FIAMMA AGLI AGENTI ATMOSFERICI.
 IMPIEGO : PER MANDATA DI PRODOTTI CHIMICI (VEDERE LA TABELLA SEL DELLA RESISTENZA CHIMICA), ACQUA DI MARE ED INDUSTRIALE.



TUBE : CAOUTCHOUC EPDM NOIR RESISTANT AUX PRODUITS CHIMIQUES.
 REINFORCEMENT : INSERTION TEXTILE HAUTE TENACITE ET 2 FILS DE MASSE ANTISTATIQUES.
 REVETEMENT : CAOUTCHOUC CR, RESISTANT A L'ABRASION, A L'OZONE, A LA FLAMME ET AUX AGENTS ATMOSPHERIQUES.
 APPLICATION : POUR REFOULEMENT DE PRODUITS CHIMIQUES (VOIR LE TABLEAU DE RESISTANCE CHIMIQUE SEL), EAU DE MER ET INDUSTRIELLE.

ID		OD		WP		BP		BR/r	W	L
inch	mm	mm	mm	bar	psi	bar	psi	mm	g/m	m
3/4"	19	31	16	232	64	928	125	626	40-46-61	
1"	25.4	37	16	232	64	928	150	746	40-46-61	
1 1/4"	32	44	16	232	64	928	175	934	40-46-61	
1 1/2"	38	51	16	232	64	928	225	1200	40-46-61	
2"	50.8	67	16	232	64	928	275	1943	40-46-61	
2 1/2"	63.5	79	16	232	64	928	300	2306	40-46-61	
3"	76.2	92	16	232	64	928	350	2713	40-46-61	
4"	101.6	118	16	232	64	928	450	3721	40-46-61	

IMPORTANT : When ordering: Clearly specify working conditions such as characteristics of fluid, concentration and working temperature. Other diameters, pressures, colours, cover type and double steel wire helix can be made upon request.

WICHTIG : Bei Aufträgen bitte Material, Konzentrat und Betriebsdruck genau angeben. Weitere Sonderwünsche wie besondere Abmessungen, Aufdrucktypen, Farben, Aussengummi und Doppelspirale auf Anfrage möglich.

IMPORTANTE : In sede d'ordine specificare: Caratteristiche del fluido, della concentrazione e della temperatura d'esercizio. Altri diametri, pressioni, colori, tipo di copertura e doppio spirale d'acciaio realizzabili su richiesta.

IMPORTANT : Mentionner avec la commande les caractéristiques de la matière, la concentration et la pression de service. Les autres diamètres, pressions, couleurs, type de revêtement et double hélice acier peuvent être produits selon la commande.



-40°C / +120°C
 -40°F / +248°F

MARKING / BESCHRIFTUNG / MARCATURA / MARQUAGE: **TRANSFER TAPE OR EMBOSSED**

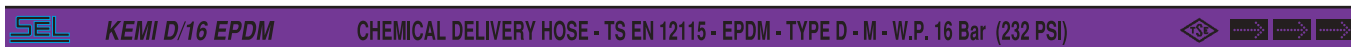

NORMS NORMEN NORME NORMES	TS EN 12115 TYPE D	COLOUR FARBEN COLORI COULEUR	
------------------------------------	--------------------	---------------------------------------	--

Chemical S&D EPDM

EN 12115



TUBE : CHEMICAL RESISTANT BLACK EPDM RUBBER.
 REINFORCEMENT : HIGH TENSILE SYNTHETIC TEXTILE, 2 STEEL WIRE HELIX AND 2 ANTISTATIC COPPER WIRES.
 COVER : WEATHER, OZONE, FLAME AND ABRASION RESISTANT CR RUBBER.
 APPLICATION : FOR SUCTION AND DISCHARGE WIDE RANGE OF CHEMICALS (SEE SEL CHEMICAL RESISTANCE CHART), SEA AND INDUSTRIAL WATER.



SEELE : BESTÄNDIG GEGEN CHEMIKALIEN, SCHWARZ, EPDM.
 EINLAGE : HOCHZUGFESTE SYNTHETISCHE TEXTILEINLAGE MIT 2 STAHLDRAHTSPIRALEN UND 2 ANTISTATISCHE KUPFERLITZEN.
 DECKE : OZON- UND WITTERUNGSBESTÄNDIGER, ABRIEBSFESTER, FLAMMWIDRIGER CR GUMMI.
 ANWENDUNG : SAUG - DRUCKSCHLAUCH GEEIGNET FÜR VIELE CHEMIKALIEN (SIEHE SEL BESTÄNDIGKEITSLISTE) MEER- UND INDUSTRIEWASSER.



SOTTOSTRATO : GOMMA EPDM NERA RESISTENTE AGLI ACIDI ED AI PRODOTTI CHIMICI.
 RINFORZO : INSERZIONI TESSILI AD ALTA TENACITÀ, CON 2 SPIRALI D'ACCIAIO E 2 CORDICELLE DI RAME ANTISTATICHE.
 COPERTURA : GOMMA CR ONDULATA RESISTENTE ALL'ABRASIONE, ALL'OZONO, ALLA FIAMMA ED AGLI AGENTI ATMOSFERICI.
 IMPIEGO : PER ASPIRAZIONE E MANDATA DI PRODOTTI CHIMICI (VEDERE LA TABELLA SEL DELLA RESISTENZA CHIMICA), ACQUA DI MARE ED INDUSTRIALE.



TUBE : CAOUTCHOUC EPDM NOIR RESISTANT AUX PRODUITS CHIMIQUES.
 RENFORCEMENT : INSERTION TEXTILE HAUTE TENACITE, 2 SPIRALES EN ACIER ET 2 FILS DE MASSE ANTISTATIQUES.
 REVETEMENT : CAOUTCHOUC CR, RESISTANT A L'ABRASION, A L'OZONE, A LA FLAMME ET AUX AGENTS ATMOSPHERIQUES.
 APPLICATION : POUR ASPIRATION ET REFOULEMENT DE PRODUITS CHIMIQUES (VOIR LE TABLEAU DE RESISTANCE CHIMIQUE SEL), EAU DE MER ET INDUSTRIELLE.

ID		OD	WP		BP		VACUUM	BR/r	W	L
inch	mm	mm	bar	psi	bar	psi	bar	mm	g/m	m
3/4"	19	31	16	232	64	928	-0.92	125	633	40-46-61
1"	25.4	37	16	232	64	928	-0.92	150	781	40-46-61
1 1/4"	32	44	16	232	64	928	-0.92	175	1027	40-46-61
1 1/2"	38	51	16	232	64	928	-0.92	225	1416	40-46-61
2"	50.8	67	16	232	64	928	-0.92	275	2203	40-46-61
2 1/2"	63.5	79	16	232	64	928	-0.92	300	2665	40-46-61
3"	76.2	92	16	232	64	928	-0.80	350	3159	40-46-61
4"	101.6	118	16	232	64	928	-0.80	450	4360	40-46-61

IMPORTANT : When ordering: Clearly specify working conditions such as characteristics of fluid, concentration and working temperature. Other diameters, pressures, colours, cover type and double steel wire helix can be made upon request.

WICHTIG : Bei Aufträgen bitte Material, Konzentrat und Betriebsdruck genau angeben. Weitere Sonderwünsche wie besondere Abmessungen, Aufdrucktypen, Farben, Aussengummi und Doppelspirale auf Anfrage möglich.

IMPORTANTE : In sede d'ordine specificare: Caratteristiche del fluido, della concentrazione e della temperatura d'esercizio. Altri diametri, pressioni, colori, tipo di copertura e doppio spirale d'acciaio realizzabili su richiesta.

IMPORTANT : Mentionner avec la commande les caracteristiques de la matiere, la concentration et la pression de service. Les autres diametres, pressions, couleurs, type de revetement et double helice acier peuvent etre produits selon la commande.



-40°C / +120°C
 -40°F / +248°F

MARKING / BESCHRIFTUNG / MARCATURA / MARQUAGE: **TRANSFER TAPE OR EMBOSSED**

SEL KEMI SD/16 EPDM CHEMICAL S/D HOSE - TS EN 12115 - EPDM - TYPE SD - M - W.P. 16 Bar (232 PSI)



NORMS
 NORMEN
 NORME
 NORMES

TS EN 12115 TYPE SD

COLOUR
 FARBEN
 COLORI
 COULEUR



Chemical Delivery CSM



TUBE : HIGH CORROSIVE CHEMICAL RESISTANT BLACK, CSM RUBBER,
 REINFORCEMENT : HIGH TENSILE SYNTHETIC TEXTILE AND ANTISTATIC COPPER WIRE.
 COVER : WEATHER, OZONE AND ABRASION RESISTANT NBR RUBBER.
 APPLICATION : FOR DISCHARGE WIDE RANGE OF CHEMICALS (SEE SEL CHEMICAL RESISTANCE CHART), SEA AND INDUSTRIAL WATER.



SEELE : BESTÄNDIG GEGEN HOCH KORROSIVE CHEMIKALIEN, SCHWARZ, CSM GUMMI.
 EINLAGE : HOCHZUGFESTE SYNTHETISCHE TEXTILEINLAGE MIT ANTISTATISCHER KUPFERLITZE.
 DECKE : OZON- UND WITTERUNGSBESTÄNDIGER, ABRIEBSFESTER NBR GUMMI.
 ANWENDUNG : DRUCKSCHLAUCH GEEIGNET FÜR VIELE CHEMIKALIEN (SIEHE SEL BESTÄNDIGKEITSLISTE) MEER- UND INDUSTRIEWASSER.



SOTTOSTRATO : GOMMA CSM NERA RESISTENTE AGLI ACIDI ED AI PRODOTTI CHIMICI ALTAMENTE CORROSIVI.
 RINFORZO : INSERZIONI TESSILI AD ALTA TENACITÀ E CORDICELLA DI RAME ANTISTATICA.
 COPERTURA : GOMMA IN NBR RESISTENTE ALL'ABRASIONE, ALL'OZONO ED AGLI AGENTI ATMOSFERICI.
 IMPIEGO : PER MANDATA DI PRODOTTI CHIMICI (VEDERE LA TABELLA SEL DELLA RESISTENZA CHIMICA), ACQUA DI MARE ED INDUSTRIALE



TUBE : CAOUTCHOUC CSM NOIR RESISTANT AUX PRODUITS CHIMIQUES FORT CORROSIFS.
 RENFORCEMENT : INSERTION TEXTILE HAUTE TENACITE ET FIL DE MASSE ANTISTATIQUE.
 REVETEMENT : CAOUTCHOUC NBR, RESISTANT A L'ABRASION, A L'OZONE ET AUX AGENTS ATMOSPHERIQUES.
 APPLICATION : POUR REFOULEMENT DE PRODUITS CHIMIQUES (VOIR LE TABLEAU DE RESISTANCE CHIMIQUE SEL), EAU DE MER ET INDUSTRIELLE.

ID		OD		WP		BP		W	L
inch	mm	mm	mm	bar	psi	bar	psi	g/m	m
3/4"	19	29		10	145	40	580	455	40-46-61
1"	25.4	35		10	145	40	580	575	40-46-61
1 1/4"	32	43		10	145	40	580	835	40-46-61
1 1/2"	38	49		10	145	40	580	965	40-46-61
1 3/4"	44.5	56		10	145	40	580	1135	40-46-61
2"	50.8	64		10	145	40	580	1475	40-46-61
2 1/2"	63.5	77		10	145	40	580	1875	40-46-61
2 3/4"	70	84		10	145	40	580	2150	40-46-61
3"	76.2	90		10	145	40	580	2290	40-46-61
4"	101.6	116		10	145	40	580	3160	40-46-61

IMPORTANT : When ordering: Clearly specify working conditions such as characteristics of fluid, concentration and working temperature. Other diameters, pressures, colours, cover type and double steel wire helix can be made upon request.
WICHTIG : Bei Aufträgen bitte Material, Konzentrat und Betriebsdruck genau angeben. Weitere Sonderwünsche wie besondere Abmessungen, Aufdrucktypen, Farben, Aussengummi und Doppelspirale auf Anfrage möglich.
IMPORTANTE : In sede d'ordine specificare: Caratteristiche del fluido, della concentrazione e della temperatura d'esercizio. Altri diametri, pressioni, colori, tipo di copertura e doppio spirale d'acciaio realizzabili su richiesta.
IMPORTANT : Mentionner avec la commande les caractéristiques de la matière, la concentration et la pression de service. Les autres diamètres, pressions, couleurs, type de revêtement et double hélice acier peuvent être produits selon la commande.



-40°C / +100°C
 -40°F / +212°F

MARKING / BESCHRIFTUNG / MARCATURA / MARQUAGE: **TRANSFER TAPE OR EMBOSSED**

SEL KEMI D/10 CSM CHEMICAL DELIVERY CSM HOSE W.P. 10 Bar (145 PSI)

NORMS NORMEN NORME NORMES	ISO 1307	COLOUR FARBEN COLORI COULEUR	
------------------------------------	----------	---------------------------------------	--

Chemical S&D CSM



TUBE : HIGH CORROSIVE CHEMICAL RESISTANT BLACK, CSM RUBBER.
 REINFORCEMENT : HIGH TENSILE SYNTHETIC TEXTILE, STEEL WIRE HELIX AND ANTISTATIC COPPER WIRE.
 COVER : WEATHER, OZONE AND ABRASION RESISTANT NBR RUBBER.
 APPLICATION : FOR SUCTION AND DISCHARGE WIDE RANGE OF CHEMICALS (SEE SEL CHEMICAL RESISTANCE CHART), SEA AND INDUSTRIAL WATER.



SEELE : BESTÄNDIG GEGEN HOCH KORROSIVE CHEMIKALIEN, SCHWARZ, CSM GUMMI.
 EINLAGE : HOCHZUGFESTE SYNTHETISCHE TEXTILEINLAGE MIT ANTISTATISCHER KUPFERLITZE.
 DECKE : OZON- UND WITTERUNGSBESTÄNDIGER, ABRIEBSFESTER NBR GUMMI.
 ANWENDUNG : SAUG - DRUCKSCHLAUCH GEEIGNET FÜR VIELE CHEMIKALIEN (SIEHE SEL BESTÄNDIGKEITSLISTE) MEER- UND INDUSTRIEWASSER



SOTTOSTRATO : GOMMA CSM NERA RESISTENTE AGLI ACIDI ED AI PRODOTTI CHIMICI ALTAMENTE CORROSIVI.
 RINFORZO : INSERZIONI TESSILI AD ALTA TENACITÀ CON SPIRALE D'ACCIAIO E CORDICELLA DI RAME ANTISTATICA.
 COPERTURA : GOMMA IN NBR RESISTENTE ALL'ABRASIONE, ALL'OZONO ED AGLI AGENTI ATMOSFERICI.
 IMPIEGO : PER ASPIRAZIONE E MANDATA DI PRODOTTI CHIMICI (VEDERE LA TABELLA SEL DELLA RESISTENZA CHIMICA), ACQUA DI MARE ED INDUSTRIALE



TUBE : CAOUTCHOUC CSM NOIR RESISTANT AUX PRODUITS CHIMIQUES FORT CORROSIFS.
 RENFORCEMENT : INSERTION TEXTILE HAUTE TENACITE, SPIRALE EN ACIER ET FIL DE MASSE ANTISTATIQUE.
 REVETEMENT : CAOUTCHOUC NBR, RESISTANT A L'ABRASION, A L'OZONE ET AUX AGENTS ATMOSPHERIQUES.
 APPLICATION : POUR ASPIRATION ET REFOULEMENT DE PRODUITS CHIMIQUES (VOIR LE TABLEAU DE RESISTANCE CHIMIQUE SEL), EAU DE MER ET INDUSTRIELLE.

ID		OD		WP		BP		VACUUM	BR/r	W	L
inch	mm	mm	bar	psi	bar	psi	bar	mm	g/m	m	
3/4"	19	30	10	145	40	580	-0.92	75	590	40-46-61	
1"	25.4	36	10	145	40	580	-0.92	100	700	40-46-61	
1 1/4"	32	44	10	145	40	580	-0.92	125	1005	40-46-61	
1 1/2"	38	51	10	145	40	580	-0.92	150	1345	40-46-61	
1 3/4"	44.5	58	10	145	40	580	-0.92	190	1590	40-46-61	
2"	50.8	66	10	145	40	580	-0.92	225	2025	40-46-61	
2 1/2"	63.5	79	10	145	40	580	-0.92	280	2630	40-46-61	
2 3/4"	70	86	10	145	40	580	-0.92	315	2990	40-46-61	
3"	76.2	92	10	145	40	580	-0.92	340	3190	40-46-61	
4"	101.6	118	10	145	40	580	-0.92	455	4255	40-46-61	

IMPORTANT : When ordering: Clearly specify working conditions such as characteristics of fluid, concentration and working temperature. Other diameters, pressures, colours, cover type and double steel wire helix can be made upon request.

WICHTIG : Bei Aufträgen bitte Material, Konzentrat und Betriebsdruck genau angeben. Weitere Sonderwünsche wie besondere Abmessungen, Aufdrucktypen, Farben, Aussengummi und Doppelspirale auf Anfrage möglich.

IMPORTANTE : In sede d'ordine specificare: Caratteristiche del fluido, della concentrazione e della temperatura d'esercizio. Altri diametri, pressioni, colori, tipo di copertura e doppio spirale d'acciaio realizzabili su richiesta.

IMPORTANT : Mentionner avec la commande les caracteristiques de la matiere, la concentration et la pression de service. Les autres diametres, pressions, couleurs, type de revetement et double helice acier peuvent etre produits selon la commande.



-40°C / +100°C
 -40°F / +212°F

MARKING / BESCHRIFTUNG / MARCATURA / MARQUAGE: **TRANSFER TAPE OR EMBOSSED**



NORMS NORMEN NORME NORMES	ISO 1307	COLOUR FARBEN COLORI COULEUR	
------------------------------------	----------	---------------------------------------	--

Acid-Solvent and Chemical Delivery

XLPE



TUBE : CHEMICALS, SOLVENTS, PETROLEUM PRODUCTS & OIL RESISTANT TRANSLUCENT XLPE.
 REINFORCEMENT : HIGH TENSILE SYNTHETIC TEXTILE AND ANTISTATIC COPPER WIRE.
 COVER : WEATHER, OZONE AND ABRASION RESISTANT EPDM RUBBER.
 APPLICATION : FOR DISCHARGE WIDE RANGE OF CHEMICALS, PETROLEUM PRODUCTS, OILS, HIGH AROMATIC SOLVENTS, ALCOHOL ETC.
 (SEE SEL CHEMICAL RESISTANCE CHART).



SEELE : GEGEN CHEMIKALIEN, LÖSUNGSMITTEL, ERDÖLPRODUKTE UND ÖLE BESTÄNDIGER, TRANSPARENTE XLPE - BESCHICHTUNG.
 EINLAGE : HOCHZUGFESTE SYNTHETISCHE TEXTILEINLAGE MIT ANTISTATISCHER KUPFERLITZE.
 DECKE : OZON- UND WITTERUNGSBESTÄNDIGER, ABRIEBSFESTER EPDM GUMMI.
 ANWENDUNG : DRUCKSCHLAUCH GEEIGNET FÜR VIELE CHEMIKALIEN; ERDÖLPRODUKTE, ÖLE, HOCHAROMATISCHE LÖSUNGSMITTEL, ALKOHOL USW.
 (SIEHE SEL BESTÄNDIGKEITSLISTE).



SOTTOSTRATO : XLPE TRANSPARENTE RESISTENTE AI SOLVENTI, PRODOTTI CHIMICI, PETROLIFERI E OLI.
 RINFORZO : INSERZIONI TESSILI AD ALTA TENACITÀ E CORDICELLA DI RAME ANTISTATICA.
 COPERTURA : GOMMA IN EPDM RESISTENTE ALL'ABRASIONE, ALL'OZONO ED AGLI AGENTI ATMOSFERICI.
 IMPIEGO : PER MANDATA DI PRODOTTI CHIMICI, PETROLIFERI, ALCOLICI, SOLVENTI SPECIALI ED OLI.
 (VEDERE LA TABELLA SEL DELLA RESISTENZA CHIMICA).



TUBE : XLPE TRANSLUCIDE RESISTANT AUX SOLVANTS, PRODUITS CHIMIQUES, PETROLIERS ET HUILES.
 RENFORCEMENT : INSERTION TEXTILE HAUTE TENACITE ET FIL DE MASSE ANTISTATIQUE.
 REVETEMENT : CAOUTCHOUC EPDM, RESISTANT A L'ABRASION, A L'OZONE ET AUX AGENTS ATMOSPHERIQUES.
 APPLICATION : POUR REFOULEMENT DE PRODUITS CHIMIQUES, PETROLIERS, SOLVANTS AROMATIQUES, ALCOOL ET HUILES ETC
 (VOIR LE TABLEAU DE RESISTANCE CHIMIQUE SEL).

ID		OD		WP		BP		W	L
inch	mm	mm	bar	psi	bar	psi	g/m	m	
3/4"	19	30	10	145	40	580	545	40-46-61	
1"	25.4	36	10	145	40	580	670	40-46-61	
1 1/4"	32	45	10	145	40	580	1017	40-46-61	
1 1/2"	38	51	10	145	40	580	1175	40-46-61	
1 3/4"	44.5	59	10	145	40	580	1585	40-46-61	
2"	50.8	65	10	145	40	580	1677	40-46-61	
2 1/2"	63.5	79	10	145	40	580	2195	40-46-61	
3"	76.2	92	10	145	40	580	2700	40-46-61	
4"	101.6	118	10	145	40	580	3605	40-46-61	

IMPORTANT : When ordering: Clearly specify working conditions such as characteristics of fluid, concentration and working temperature.
 Other diameters, pressures, colours, cover type and double steel wire helix can be made upon request.

WICHTIG : Bei Aufträgen bitte Material, Konzentrat und Betriebsdruck genau angeben. Weitere Sonderwünsche wie besondere Abmessungen, Aufdrucktypen, Farben, Aussengummi und Doppelspirale auf Anfrage möglich.

IMPORTANTE : In sede d'ordine specificare: Caratteristiche del fluido, della concentrazione e della temperatura d'esercizio.
 Altri diametri, pressioni, colori, tipo di copertura e doppio spirale d'acciaio realizzabili su richiesta.



IMPORTANT : Mentionner avec la commande les caracteristiques de la matiere, la concentration et la pression de service.
 Les autres diametres, pressions, couleurs, type de revetement et double helice acier peuvent etre produits selon la commande.



-40°C / + 80°C
 -40°F / +176°F

MARKING / BESCHRIFTUNG / MARCATURA / MARQUAGE: **TRANSFER TAPE OR EMBOSSED**



NORMS NORMEN NORME NORMES	ISO 1307	COLOUR FARBEN COLORI COULEUR	 
------------------------------------	----------	---------------------------------------	---

Acid-Solvent and Chemical S&D



XLPE



TUBE : CHEMICALS, SOLVENTS, PETROLEUM PRODUCTS & OIL RESISTANT TRANSLUCENT XLPE.
 REINFORCEMENT : HIGH TENSILE SYNTHETIC TEXTILE, STEEL WIRE HELIX AND ANTISTATIC COPPER WIRE.
 COVER : WEATHER, OZONE AND ABRASION RESISTANT EPDM RUBBER.
 APPLICATION : FOR SUCTION AND DISCHARGE WIDE RANGE OF CHEMICALS, PETROLEUM PRODUCTS, OILS, HIGH AROMATIC SOLVENTS, ALCOHOL ETC. (SEE SEL CHEMICAL RESISTANCE CHART).



SEELE : GEGEN CHEMIKALIEN, LÖSUNGSMITTEL, ERDÖLPRODUKTE UND ÖLE BESTÄNDIGER, TRANSPARENTE XLPE - BESCHICHTUNG.
 EINLAGE : HOCHZUGFESTE SYNTHETISCHE TEXTILEINLAGE MIT EINER STAHLDRAHTSPIRALE UND ANTISTATISCHER KUPFERLITZE.
 DECKE : OZON- UND WITTERUNGSBESTÄNDIGER, ABRIEBSFESTER EPDM GUMMI.
 ANWENDUNG : SAUG - DRUCKSCHLAUCH GEEIGNET FÜR VIELE CHEMIKALIEN; ERDÖLPRODUKTE, ÖLE, HOCHAROMATISCHE LÖSUNGSMITTEL, ALKOHOL USW. (SIEHE SEL BESTÄNDIGKEITSLISTE).



SOTTOSTRATO : XLPE TRANSPARENTE RESISTENTE AI SOLVENTI, PRODOTTI CHIMICI, PETROLIFERI E OLI.
 RINFORZO : INSERZIONI TESSILI AD ALTA TENACITÀ, CON SPIRALE D'ACCIAIO E CORDICELLA DI RAME ANTISTATICA.
 COPERTURA : GOMMA IN EPDM RESISTENTE ALL'ABRASIONE, ALL'OZONO ED AGLI AGENTI ATMOSFERICI.
 IMPIEGO : PER ASPIRAZIONE E MANDATA DEI PRODOTTI CHIMICI, PETROLIFERI, ALCOLICI, SOLVENTI SPECIALI ED OLI. (VEDERE LA TABELLA SEL DELLA RESISTENZA CHIMICA).



TUBE : XLPE TRANSLUCIDE RESISTANT AUX SOLVANTS, PRODUITS CHIMIQUES, PETROLIERS ET HUILES.
 RENFORCEMENT : INSERTION TEXTILE HAUTE TENACITE, SPIRALE EN ACIER ET FIL DE MASSE ANTISTATIQUE.
 REVETEMENT : CAOUTCHOUC EPDM, RESISTANT A L'ABRASION, A L'OZONE ET AUX AGENTS ATMOSPHERIQUES.
 APPLICATION : POUR ASPIRATION ET REFOULEMENT DE PRODUITS CHIMIQUES, PETROLIERS, SOLVANTS AROMATIQUES, ALCOOL ET HUILES ETC (VOIR LE TABLEAU DE RESISTANCE CHIMIQUE SEL).

ID		OD		WP		BP		VACUUM	BR/r	W	L
inch	mm	mm	bar	psi	bar	psi	bar	mm	g/m	m	
3/4"	19	31	10	145	40	580	-0.92	80	670	40-46-61	
1"	25.4	37	10	145	40	580	-0.92	110	815	40-46-61	
1 1/4"	32	45	10	145	40	580	-0.92	165	1125	40-46-61	
1 1/2"	38	52	10	145	40	580	-0.92	225	1460	40-46-61	
1 3/4"	44.5	59	10	145	40	580	-0.92	285	1780	40-46-61	
2"	50.8	67	10	145	40	580	-0.92	350	2260	40-46-61	
2 1/2"	63.5	80	10	145	40	580	-0.92	450	2820	40-46-61	
2 3/4"	70	87	10	145	40	580	-0.92	550	3190	40-46-61	
3"	76.2	93	10	145	40	580	-0.92	800	3425	40-46-61	
4"	101.6	120	10	145	40	580	-0.92	1200	5290	40-46-61	

IMPORTANT : When ordering: Clearly specify working conditions such as characteristics of fluid, concentration and working temperature. Other diameters, pressures, colours, cover type and double steel wire helix can be made upon request.

WICHTIG : Bei Aufträgen bitte Material, Konzentrat und Betriebsdruck genau angeben. Weitere Sonderwünsche wie besondere Abmessungen, Aufdrucktypen, Farben, Aussengummi und Doppelspirale auf Anfrage möglich.

IMPORTANTE : In sede d'ordine specificare: Caratteristiche del fluido, della concentrazione e della temperatura d'esercizio. Altri diametri, pressioni, colori, tipo di copertura e doppio spirale d'acciaio realizzabili su richiesta.



IMPORTANT : Mentionner avec la commande les caractéristiques de la matière, la concentration et la pression de service. Les autres diamètres, pressions, couleurs, type de revêtement et double hélice acier peuvent être produits selon la commande.



-40°C / + 80°C
 -40°F / +176°F

MARKING / BESCHRIFTUNG / MARCATURA / MARQUAGE: **TRANSFER TAPE OR EMBOSSED**





SEL KEMI SD/10 XLPE ACID - SOLVENT AND CHEMICAL S/D XLPE HOSE W.P. 10 Bar (145 PSI)

NORMS NORMEN NORME NORMES	ISO 1307	COLOUR FARBEN COLORI COULEUR	 
------------------------------------	----------	---------------------------------------	--

Acid-Solvent and Chemical S&D

XLPE-FLAT CORRUGATED



	TUBE REINFORCEMENT COVER APPLICATION	: CHEMICALS, SOLVENTS, PETROLEUM PRODUCTS & OIL RESISTANT TRANSLUCENT XLPE. : HIGH TENSILE SYNTHETIC TEXTILE, STEEL WIRE HELIX AND ANTISTATIC COPPER WIRE. : WEATHER, OZONE AND ABRASION RESISTANT EPDM RUBBER. FLAT CORRUGATED : FOR SUCTION AND DISCHARGE WIDE RANGE OF CHEMICALS, PETROLEUM PRODUCTS, OILS, HIGH AROMATIC SOLVENTS, ALCOHOL ETC. (SEE SEL CHEMICAL RESISTANCE CHART).
	SEELE EINLAGE DECKE ANWENDUNG	: GEGEN CHEMIKALIEN, LÖSUNGSMITTEL, ERDÖLPRODUKTE UND ÖLE BESTÄNDIGER, TRANSPARENTE XLPE - BESCHICHTUNG. : HOCHZUGFESTE SYNTHETISCHE TEXTILEINLAGE MIT EINER STAHLDRAHTSPIRALE UND ANTISTATISCHER KUPFERLITZE. : OZON- UND WITTERUNGSBESTÄNDIGER, ABRIEBSFESTER EPDM GUMMI; LEICHT GEWELLT. : SAUG - DRUCKSCHLAUCH GEEIGNET FÜR VIELE CHEMIKALIEN; ERDÖLPRODUKTE, ÖLE, HOCHAROMATISCHE LÖSUNGSMITTEL, ALKOHOL USW. (SIEHE SEL BESTÄNDIGKEITSLISTE).
	SOTTOSTRATO RINFORZO COPERTURA IMPIEGO	: XLPE TRANSPARENTE RESISTENTE AI SOLVENTI, PRODOTTI CHIMICI, PETROLIFERI E OLI. : INSERZIONI TESSILI AD ALTA TENACITÀ, CON SPIRALE D'ACCIAIO E CORDICELLA DI RAME ANTISTATICA. : GOMMA IN EPDM ONDULATA PIATTA RESISTENTE ALL'ABRASIONE, ALL'OZONO ED AGLI AGENTI ATMOSFERICI. : PER ASPIRAZIONE E MANDATA DI PRODOTTI CHIMICI, PETROLIFERI, ALCOLICI, SOLVENTI SPECIALI ED OLI. (VEDERE LA TABELLA SEL DELLA RESISTENZA CHIMICA).
	TUBE REINFORCEMENT REVETEMENT APPLICATION	: XLPE TRANSLUCIDE RESISTANT AUX SOLVANTS, PRODUITS CHIMIQUES, PETROLIERS ET HUILES. : INSERTION TEXTILE HAUTE TENACITE, SPIRALE EN ACIER ET FIL DE MASSE ANTISTATIQUE. : CAOUTCHOUC EPDM ONDULE PLAT, RESISTANT A L'ABRASION, A L'OZONO ET AUX AGENTS ATMOSPHERIQUES. : POUR ASPIRATION ET REFOULEMENT DE PRODUITS CHIMIQUES, PETROLIERS, SOLVANTS AROMATIQUES, ALCOOL ET HUILES ETC (VOIR LE TABLEAU DE RESISTANCE CHIMIQUE SEL).

ID		OD		WP		BP		VACUUM	BR/r	W	L
inch	mm	mm	mm	bar	psi	bar	psi	bar	mm	g/m	m
3/4"	19	29	10	145	30	435	-0.92	70	490	40-46-61	
1"	25.4	36	10	145	30	435	-0.92	100	642	40-46-61	
1 1/4"	32	43	10	145	30	435	-0.92	130	955	40-46-61	
1 1/2"	38	50	10	145	30	435	-0.92	160	1110	40-46-61	
2"	50.8	64	10	145	30	435	-0.92	250	1600	40-46-61	
2 1/2"	63.5	78	10	145	30	435	-0.92	350	2260	40-46-61	
3"	76.2	91	10	145	30	435	-0.92	450	2600	40-46-61	
4"	101.6	119	10	145	30	435	-0.92	700	4325	40-46-61	
5"	127	148	10	145	30	435	-0.92	900	6750	40-46-61	

- IMPORTANT** : When ordering: Clearly specify working conditions such as characteristics of fluid, concentration and working temperature.
Other diameters, pressures, colours, cover type and double steel wire helix can be made upon request.
- WICHTIG** : Bei Aufträgen bitte Material, Konzentrat und Betriebsdruck genau angeben. Weitere Sonderwünsche wie besondere Abmessungen, Aufdrucktypen, Farben, Aussengummi und Doppelspirale auf Anfrage möglich.
- IMPORTANTE** : In sede d'ordine specificare: Caratteristiche del fluido, della concentrazione e della temperatura d'esercizio.
Altri diametri, pressioni, colori, tipo di copertura e doppio spirale d'acciaio realizzabili su richiesta.
- IMPORTANT** : Mentionner avec la commande les caracteristiques de la matiere, la concentration et la pression de service.
Les autres diametres, pressions, couleurs, type de revetement et double helice acier peuvent etre produits selon la commande.



MARKING / BESCHRIFTUNG / MARCATURA / MARQUAGE: **TRANSFER TAPE OR EMBOSSED**

SEL KEMI SDFC/10 XLPE ACID - SOLVENT AND CHEMICAL S/D XLPE HOSE W.P. 10 Bar (145 PSI)

NORMS NORMEN NORME NORMES	ISO 1307	COLOUR FARBEN COLORI COULEUR	 
------------------------------------	----------	---------------------------------------	---

Acid-Solvent and Chemical Delivery



XLPE-EN 12115



TUBE : CHEMICALS, SOLVENTS, PETROLEUM PRODUCTS & OIL RESISTANT TRANSLUCENT XLPE.
 REINFORCEMENT : HIGH TENSILE SYNTHETIC TEXTILE, AND 2 ANTISTATIC COPPER WIRES.
 COVER : WEATHER, OZONE, FLAME AND ABRASION RESISTANT CR RUBBER.
 APPLICATION : FOR DISCHARGE WIDE RANGE OF CHEMICALS, PETROLEUM PRODUCTS, OILS, HIGH AROMATIC SOLVENTS, ALCOHOL ETC.
 (SEE SEL CHEMICAL RESISTANCE CHART).



SEELE : GEGEN CHEMIKALIEN, LÖSUNGSMITTEL, ERDÖLPRODUKTE UND ÖLE BESTÄNDIGER, TRANSPARENTE XLPE - BESCHICHTUNG.
 EINLAGE : HOCHZUGFESTE SYNTHETISCHE TEXTILEINLAGE MIT 2 ANTISTATISCHE KUPFERLITZEN.
 DECKE : OZON- UND WITTERUNGSBESTÄNDIGER, ABRIEBSFESTER; FLAMMWIDRIGER CR GUMMI.
 ANWENDUNG : DRUCKSCHLAUCH GEEIGNET FÜR VIELE CHEMIKALIEN; ERDÖLPRODUKTE, ÖLE, HOCHAROMATISCHE LÖSUNGSMITTEL, ALKOHOL USW.
 (SIEHE SEL BESTÄNDIGKEITSLISTE).



SOTTOSTRATO : XLPE TRANSPARENTE RESISTENTE AI SOLVENTI, PRODOTTI CHIMICI, PETROLIFERI E OLI.
 RINFORZO : INSERZIONI TESSILI AD ALTA TENACITÀ CON 2 CORDICELLE DI RAME ANTISTATICHE.
 COPERTURA : GOMMA IN CR RESISTENTE ALL'ABRASIONE, ALL'OZONO ED AGLI AGENTI ATMOSFERICI.
 IMPIEGO : PER MANDATA DI PRODOTTI CHIMICI, PETROLIFERI, ALCOLICI, SOLVENTI SPECIALI ED OLI.
 (VEDERE LA TABELLA SEL DELLA RESISTENZA CHIMICA).



TUBE : XLPE TRANSLUCIDE RESISTANT AUX SOLVANTS, PRODUITS CHIMIQUES, PETROLIERS ET HUILES.
 RENFORCEMENT : INSERTION TEXTILE HAUTE TENACITE ET 2 FILS DE MASSE ANTISTATIQUES.
 REVETEMENT : CAOUTCHOUC CR, RESISTANT A L'ABRASION, A L'OZONE, A LA FLAMME ET AUX AGENTS ATMOSPHERIQUES.
 APPLICATION : POUR REFOULEMENT DE PRODUITS CHIMIQUES, PETROLIERS, SOLVANTS AROMATIQUES, ALCOOL ET HUILES ETC
 (VOIR LE TABLEAU DE RESISTANCE CHIMIQUE SEL).

ID		OD	WP		BP		BR/r	W	L
inch	mm	mm	bar	psi	bar	psi	mm	g/m	m
3/4"	19	31	16	232	64	928	187	598	40-46-61
1"	25.4	37	16	232	64	928	225	712	40-46-61
1 1/4"	32	44	16	232	64	928	262	925	40-46-61
1 1/2"	38	51	16	232	64	928	338	1191	40-46-61
2"	50.8	67	16	232	64	928	410	1909	40-46-61
2 1/2"	63.5	79	16	232	64	928	450	2217	40-46-61
3"	76.2	92	16	232	64	928	525	2652	40-46-61
4"	101.6	118	16	232	64	928	675	3651	40-46-61

IMPORTANT : When ordering: Clearly specify working conditions such as characteristics of fluid, concentration and working temperature.
 Other diameters, pressures, colours, cover type and double steel wire helix can be made upon request.

WICHTIG : Bei Aufträgen bitte Material, Konzentrat und Betriebsdruck genau angeben. Weitere Sonderwünsche wie besondere Abmessungen, Aufdrucktypen, Farben, Aussengummi und Doppelspirale auf Anfrage möglich.

IMPORTANTE : In sede d'ordine specificare: Caratteristiche del fluido, della concentrazione e della temperatura d'esercizio.
 Altri diametri, pressioni, colori, tipo di copertura e doppio spirale d'acciaio realizzabili su richiesta.

IMPORTANT : Mentionner avec la commande les caracteristiques de la matiere, la concentration et la pression de service.
 Les autres diametres, pressions, couleurs, type de revetement et double helice acier peuvent etre produits selon la commande.



-40°C / + 80°C
 -40°F / +176°F

MARKING / BESCHRIFTUNG / MARCATURA / MARQUAGE: **TRANSFER TAPE OR EMBOSSED**

SEL KEMI D/16 XLPE ACID - SOLVENT AND CHEMICAL DELIVERY HOSE - TS EN 12115 - XLPE - TYPE D - M - W.P. 16 Bar (232 PSI)

NORMS NORMEN NORME NORMES	TS EN 12115 TYPE D	COLOUR FARBEN COLORI COULEUR	
------------------------------------	--------------------	---------------------------------------	--

Acid-Solvent and Chemical S&D

XLPE-EN 12115



TUBE : CHEMICALS, SOLVENTS, PETROLEUM PRODUCTS & OIL RESISTANT TRANSLUCENT XLPE.
 REINFORCEMENT : HIGH TENSILE SYNTHETIC TEXTILE, 2 STEEL WIRE HELIX AND 2 ANTISTATIC COPPER WIRES.
 COVER : WEATHER, OZONE, ABRASION AND FLAME RESISTANT CR RUBBER.
 APPLICATION : FOR SUCTION AND DISCHARGE WIDE RANGE OF CHEMICALS, PETROLEUM PRODUCTS, OILS, HIGH AROMATIC SOLVENTS, ALCOHOL ETC. (SEE SEL CHEMICAL RESISTANCE CHART).



SEELE : GEGEN CHEMIKALIEN, LÖSUNGSMITTEL, ERDÖLPRODUKTE UND ÖLE BESTÄNDIGER, TRANSPARENTE XLPE - BESCHICHTUNG.
 EINLAGE : HOCHZUGFESTE SYNTHETISCHE TEXTILEINLAGE MIT 2 STAHLDRAHTSPIRALEN UND 2 ANTISTATISCHER KUPFERLITZEN.
 DECKE : OZON- UND WITTERUNGSBESTÄNDIGER, ABRIEBSFESTER, FLAMMWIDRIGER CR GUMMI.
 ANWENDUNG : SAUG - DRUCKSCHLAUCH GEEIGNET FÜR VIELE CHEMIKALIEN; ERDÖLPRODUKTE, ÖLE, HOCHAROMATISCHE LÖSUNGSMITTEL, ALKOHOL USW. (SIEHE SEL BESTÄNDIGKEITSLISTE).



SOTTOSTRATO : XLPE TRANSPARENTE RESISTENTE AI SOLVENTI, PRODOTTI CHIMICI, PETROLIFERI E OLI.
 RINFORZO : INSERZIONI TESSILI AD ALTA TENACITÀ, CON 2 SPIRALI D'ACCIAIO E 2 CORDICELLE DI RAME ANTISTATICHE.
 COPERTURA : GOMMA IN CR RESISTENTE ALL'ABRASIONE, ALL'OZONO ED AGLI AGENTI ATMOSFERICI.
 IMPIEGO : PER ASPIRAZIONE E MANDATA DI PRODOTTI CHIMICI, PETROLIFERI, ALCOLICI, SOLVENTI SPECIALI ED OLI. (VEDERE LA TABELLA SEL DELLA RESISTENZA CHIMICA).



TUBE : XLPE TRANSLUCIDE RESISTANT AUX SOLVANTS, PRODUITS CHIMIQUES, PETROLIERS ET HUILES.
 REINFORCEMENT : INSERTION TEXTILE HAUTE TENACITE, 2 SPIRALES EN ACIER ET 2 FILS DE MASSE ANTISTATIQUES.
 REVETEMENT : CAOUTCHOUC CR, RESISTANT A L'ABRASION, A L'OZONE ET AUX AGENTS ATMOSPHERIQUES.
 APPLICATION : POUR ASPIRATION ET REFOULEMENT DE PRODUITS CHIMIQUES, PETROLIERS, SOLVANTS AROMATIQUES, ALCOOL ET HUILES ETC (VOIR LE TABLEAU DE RESISTANCE CHIMIQUE SEL).

ID		OD		WP		BP		VACUUM	BR/r	W	L
inch	mm	mm	mm	bar	psi	bar	psi	bar	mm	g/m	m
3/4"	19	31	16	232	64	928	-0.92	187	644	40-46-61	
1"	25.4	37	16	232	64	928	-0.92	225	816	40-46-61	
1 1/4"	32	44	16	232	64	928	-0.92	262	1024	40-46-61	
1 1/2"	38	51	16	232	64	928	-0.92	338	1382	40-46-61	
2"	50.8	67	16	232	64	928	-0.92	410	2240	40-46-61	
2 1/2"	63.5	79	16	232	64	928	-0.92	450	2652	40-46-61	
3"	76.2	92	16	232	64	928	-0.92	525	3266	40-46-61	
4"	101.6	118	16	232	64	928	-0.92	675	4839	40-46-61	

IMPORTANT : When ordering: Clearly specify working conditions such as characteristics of fluid, concentration and working temperature. Other diameters, pressures, colours, cover type and double steel wire helix can be made upon request.
WICHTIG : Bei Aufträgen bitte Material, Konzentrat und Betriebsdruck genau angeben. Weitere Sonderwünsche wie besondere Abmessungen, Aufdrucktypen, Farben, Aussengummi und Doppelspirale auf Anfrage möglich.
IMPORTANTE : In sede d'ordine specificare: Caratteristiche del fluido, della concentrazione e della temperatura d'esercizio. Altri diametri, pressioni, colori, tipo di copertura e doppio spirale d'acciaio realizzabili su richiesta.
IMPORTANT : Mentionner avec la commande les caractéristiques de la matière, la concentration et la pression de service. Les autres diamètres, pressions, couleurs, type de revêtement et double hélice acier peuvent être produits selon la commande.



-40°C / + 80°C
 -40°F / +176°F



MARKING / BESCHRIFTUNG / MARCATURA / MARQUAGE: **TRANSFER TAPE OR EMBOSSED**

SEL KEMI SD/16 XLPE ACID - SOLVENT AND CHEMICAL S/D HOSE - TS EN 12115 - XLPE - TYPE SD - M - W.P. 16 Bar (232 PSI)

NORMS NORMEN NORME NORMES	TS EN 12115 TYPE SD	COLOUR FARBEN COLORI COULEUR	
------------------------------------	---------------------	---------------------------------------	--

Acid-Solvent and Chemical Delivery

UHMW-PE



TUBE : TRANSLUCENT, FOOD GRADE UHMW-PE LINER SUITABLE FOR WIDE RANGE OF CORROSIVE CHEMICALS AND SOLVENTS.
 REINFORCEMENT : HIGH TENSILE SYNTHETIC TEXTILE AND ANTISTATIC COPPER WIRES.
 COVER : WEATHER, OZONE, ABRASION RESISTANT EPDM RUBBER.
 APPLICATION : FOR DISCHARGE OF ALL CORROSIVE CHEMICALS, ESPECIALLY HIGH AROMATIC SOLVENTS (SEE SEL CHEMICAL RESISTANCE CHART).



SEELE : GEGEN KORROSIVE CHEMIKALIEN UND LÖSUNGSMITTEL BESTÄNDIGER, TRANSPARENTER, LEBENSMITTELECHTER UHMW-PE INLINER.
 EINLAGE : HOCHZUGFESTE SYNTHETISCHE TEXTILEINLAGE UND ANTISTATISCHER KUPFERLITZE.
 DECKE : OZON- UND WITTERUNGSBESTÄNDIGER, ABRIEBSFESTER EPDM GUMMI.
 ANWENDUNG : DRUCKSCHLAUCH GEEIGNET FÜR VIELE KORROSIVE CHEMIKALIEN, HOCHAROMATISCHE LÖSUNGSMITTEL (SIEHE SEL BESTÄNDIGKEITSLISTE).



SOTTOSTRATO : UHMW-PE - TRANSPARENTE, DI QUALITÀ ALIMENTARE, RESISTENTE AI PRODOTTI CHIMICI ALTAMENTE CORROSIVI E SOLVENTI.
 RINFORZO : INSERZIONI TESSILI AD ALTA TENACITÀ E CORDICELLA DI RAME ANTISTATICA.
 COPERTURA : GOMMA IN EPDM RESISTENTE ALL'ABRASIONE, ALL'OZONO ED AGLI AGENTI ATMOSFERICI.
 IMPIEGO : PER MANDATA DI PRODOTTI CHIMICI CORROSIVI, INCLUSI GLI AROMATICI, SOLVENTI ETC. (VEDERE LA TABELLA SEL DELLA RESISTENZA CHIMICA).



TUBE : UHMW-PE TRANSLUCIDE, DE QUALITE ALIMENTAIRE, RESISTANT AUX PRODUITS CHIMIQUES CORROSIFS.
 RENFORCEMENT : INSERTION TEXTILE HAUTE TENACITE ET FIL DE MASSE ANTISTATIQUE.
 REVETEMENT : CAOUTCHOUC EPDM, RESISTANT A L'ABRASION, A L'OZONE ET AUX AGENTS ATMOSPHERIQUES.
 APPLICATION : POUR REFOULEMENT DE TOUTS LES PRODUITS CHIMIQUES CORROSIFS. EN PARTICULIER LES SOLVANTS AROMATIQUES (VOIR LE TABLEAU DE RESISTANCE CHIMIQUE SEL).

ID		OD	WP		BP		W	L
inch	mm	mm	bar	psi	bar	psi	g/m	m
3/4"	19	30	10	145	40	580	563	40-46-61
1"	25.4	36	10	145	40	580	662	40-46-61
1 1/4"	32	45	10	145	40	580	1185	40-46-61
1 1/2"	38	51	10	145	40	580	1584	40-46-61
1 3/4"	44.5	59	10	145	40	580	1750	40-46-61
2"	50.8	65	10	145	40	580	2230	40-46-61
2 1/2"	63.5	79	10	145	40	580	2500	40-46-61
2 3/4"	70	86	10	145	40	580	2705	40-46-61
3"	76.2	92	10	145	40	580	3765	40-46-61
4"	101.6	118	10	145	40	580	3210	40-46-61

IMPORTANT : When ordering: Clearly specify working conditions such as characteristics of fluid, concentration and working temperature. Other diameters, pressures, colours, cover type and double steel wire helix can be made upon request.
WICHTIG : Bei Aufträgen bitte Material, Konzentrat und Betriebsdruck genau angeben. Weitere Sonderwünsche wie besondere Abmessungen, Aufdrucktypen, Farben, Aussengummi und Doppelspirale auf Anfrage möglich.
IMPORTANTE : In sede d'ordine specificare: Caratteristiche del fluido, della concentrazione e della temperatura d'esercizio. Altri diametri, pressioni, colori, tipo di copertura e doppio spirale d'acciaio realizzabili su richiesta.
IMPORTANT : Mentionner avec la commande les caracteristiques de la matiere, la concentration et la pression de service. Les autres diametres, pressions, couleurs, type de revetement et double helice acier peuvent etre produits selon la commande.



-40°C / + 80°C
 -40°F / +176°F

MARKING / BESCHRIFTUNG / MARCATURA / MARQUAGE: **TRANSFER TAPE OR EMBOSSED**

SEL KEMI D/10 UHMW-PE ACID - SOLVENT AND CHEMICAL DELIVERY UHMW-PE HOSE W.P. 10 Bar (145 PSI)

NORMS NORMEN NORME NORMES	ISO 1307	COLOUR FARBEN COLORI COULEUR			
------------------------------------	----------	---------------------------------------	--	--	--

Acid-Solvent and Chemical S&D



UHMW-PE



TUBE : TRANSLUCENT, FOOD GRADE UHMW-PE LINER SUITABLE FOR WIDE RANGE OF CORROSIVE CHEMICALS AND SOLVENTS.
 REINFORCEMENT : HIGH TENSILE SYNTHETIC TEXTILE, STEEL WIRE HELIX AND ANTISTATIC COPPER WIRE.
 COVER : WEATHER, OZONE, ABRASION RESISTANT EPDM RUBBER.
 APPLICATION : FOR SUCTION AND DISCHARGE OF ALL CORROSIVE CHEMICALS, ESPECIALLY HIGH AROMATIC SOLVENTS (SEE SEL CHEMICAL RESISTANCE CHART).



SEELE : GEGEN KORROSIVE CHEMIKALIEN UND LÖSUNGSMITTEL BESTÄNDIGER, TRANSPARENTER, LEBENSMITTELECHTER UHMW-PE INLINER.
 EINLAGE : HOCHZUGFESTE SYNTHETISCHE TEXTILEINLAGE MIT EINER STAHLDRAHTSPIRALE UND ANTISTATISCHER KUPFERLITZE.
 DECKE : OZON- UND WITTERUNGSBESTÄNDIGER, ABRIEBSFESTER EPDM GUMMI.
 ANWENDUNG : SAUG - DRUCKSCHLAUCH GEEIGNET FÜR VIELE KORROSIVE CHEMIKALIEN, HOCHAROMATISCHE LÖSUNGSMITTEL (SIEHE SEL BESTÄNDIGKEITSLISTE).



SOTTOSTRATO : UHMW-PE - TRANSPARENTE, DI QUALITÀ ALIMENTARE, RESISTENTE AI PRODOTTI CHIMICI ALTAMENTE CORROSIVI E SOLVENTI.
 RINFORZO : INSERZIONI TESSILI AD ALTA TENACITÀ, CON SPIRALE D'ACCIAIO E CORDICELLA DI RAME ANTISTATICA.
 COPERTURA : GOMMA IN EPDM RESISTENTE ALL'ABRASIONE, ALL'OZONO ED AGLI AGENTI ATMOSFERICI.
 IMPIEGO : PER ASPIRAZIONE E MANDATA DI PRODOTTI CHIMICI CORROSIVI, INCLUSI GLI AROMATICI, SOLVENTI ETC. (VEDERE LA TABELLA SEL DELLA RESISTENZA CHIMICA).



TUBE : UHMW-PE TRANSLUCIDE, DE QUALITE ALIMENTAIRE, RESISTANT AUX PRODUITS CHIMIQUES CORROSIFS.
 RENFORCEMENT : INSERTION TEXTILE HAUTE TENACITE, SPIRALE EN ACIER ET FIL DE MASSE ANTISTATIQUE.
 REVETEMENT : CAOUTCHOUC EPDM, RESISTANT A L'ABRASION, A L'OZONE ET AUX AGENTS ATMOSPHERIQUES.
 APPLICATION : POUR ASPIRATION ET REFOULEMENT DE TOUS LES PRODUITS CHIMIQUES CORROSIFS. EN PARTICULIER LES SOLVANTS AROMATIQUES (VOIR LE TABLEAU DE RESISTANCE CHIMIQUE SEL).

ID		OD		WP		BP		VACUUM	BR/r	W	L
inch	mm	mm	bar	psi	bar	psi	bar	mm	g/m	m	
3/4"	19	31	10	145	40	580	-0.92	80	690	40-46-61	
1"	25.4	37	10	145	40	580	-0.92	110	815	40-46-61	
1 1/4"	32	45	10	145	40	580	-0.92	165	1120	40-46-61	
1 1/2"	38	52	10	145	40	580	-0.92	225	1495	40-46-61	
1 3/4"	44.5	59	10	145	40	580	-0.92	285	1815	40-46-61	
2"	50.8	67	10	145	40	580	-0.92	350	2275	40-46-61	
2 1/2"	63.5	80	10	145	40	580	-0.92	450	2775	40-46-61	
2 3/4"	70	87	10	145	40	580	-0.92	550	3175	40-46-61	
3"	76.2	93	10	145	40	580	-0.92	800	3315	40-46-61	
4"	101.6	120	10	145	40	580	-0.92	1200	4880	40-46-61	

IMPORTANT : When ordering: Clearly specify working conditions such as characteristics of fluid, concentration and working temperature.
 Other diameters, pressures, colours, cover type and double steel wire helix can be made upon request.
WICHTIG : Bei Aufträgen bitte Material, Konzentrat und Betriebsdruck genau angeben. Weitere Sonderwünsche wie besondere Abmessungen, Aufdrucktypen, Farben, Aussengummi und Doppelspirale auf Anfrage möglich.
IMPORTANTE : In sede d'ordine specificare: Caratteristiche del fluido, della concentrazione e della temperatura d'esercizio.
 Altri diametri, pressioni, colori, tipo di copertura e doppio spirale d'acciaio realizzabili su richiesta.
IMPORTANT : Mentionner avec la commande les caracteristiques de la matiere, la concentration et la pression de service.
 Les autres diametres, pressions, couleurs, type de revetement et double helice acier peuvent etre produits selon la commande.



-40°C / + 80°C
 -40°F / +176°F

MARKING / BESCHRIFTUNG / MARCATURA / MARQUAGE: **TRANSFER TAPE OR EMBOSSED**



NORMS NORMEN NORME NORMES	ISO 1307	COLOUR FARBEN COLORI COULEUR	
------------------------------------	----------	---------------------------------------	--

Acid-Solvent and Chemical S&D

CORRUGATED - UHMW-PE



TUBE : TRANSLUCENT, FOOD GRADE UHMW-PE LINER SUITABLE FOR WIDE RANGE OF CORROSIVE CHEMICALS AND SOLVENTS.
 REINFORCEMENT : HIGH TENSILE SYNTHETIC TEXTILE, STEEL WIRE HELIX AND ANTISTATIC COPPER WIRE.
 COVER : WEATHER, OZONE, ABRASION RESISTANT CORRUGATED EPDM RUBBER.
 APPLICATION : FOR SUCTION AND DISCHARGE OF ALL CORROSIVE CHEMICALS, ESPECIALLY HIGH AROMATIC SOLVENTS (SEE SEL CHEMICAL RESISTANCE CHART).



SEELE : GEGEN KORROSIVE CHEMIKALIEN UND LÖSUNGSMITTEL BESTÄNDIGER, TRANSPARENTER, LEBENSMITTELECHTER UHMW-PE INLINER.
 EINLAGE : HOCHZUGFESTE SYNTHETISCHE TEXTILEINLAGE MIT EINER STAHLDRAHTSPIRALE UND ANTISTATISCHER KUPFERLITZE.
 DECKE : OZON- UND WITTERUNGSBESTÄNDIGER, ABRIEBSFESTER EPDM GUMMI, GEWELLT.
 ANWENDUNG : SAUG- DRUCKSCHLAUCH GEEIGNET FÜR VIELE KORROSIVE CHEMIKALIEN, HOCHAROMATISCHE LÖSUNGSMITTEL (SIEHE SEL BESTÄNDIGKEITSLISTE).



SOTTOSTRATO : UHMW-PE - TRANSPARENTE, DI QUALITÀ ALIMENTARE, RESISTENTE AI PRODOTTI CHIMICI ALTAMENTE CORROSIVI E SOLVENTI.
 RINFORZO : INSERZIONI TESSILI AD ALTA TENACITÀ, CON SPIRALE D'ACCIAIO E CORDICELLA DI RAME ANTISTATICA.
 COPERTURA : GOMMA IN EPDM ONDULATA, RESISTENTE ALL'ABRASIONE, ALL'OZONO ED AGLI AGENTI ATMOSFERICI.
 IMPIEGO : PER ASPIRAZIONE E MANDATA DI PRODOTTI CHIMICI CORROSIVI, INCLUSI GLI AROMATICI, SOLVENTI ETC. (VEDERE LA TABELLA SEL DELLA RESISTENZA CHIMICA).



TUBE : UHMW-PE TRANSLUCIDE, DE QUALITE ALIMENTAIRE, RESISTANT AUX PRODUITS CHIMIQUES CORROSIFS.
 RENFORCEMENT : INSERTION TEXTILE HAUTE TENACITE, SPIRALE EN ACIER ET FIL DE MASSE ANTISTATIQUE.
 REVETEMENT : CAOUTCHOUC EPDM ONDULE, RESISTANT A L'ABRASION, A L'OZONE ET AUX AGENTS ATMOSPHERIQUES.
 APPLICATION : POUR ASPIRATION ET REFOULEMENT DE TOUS LES PRODUITS CHIMIQUES CORROSIFS. EN PARTICULIER LES SOLVANTS AROMATIQUES (VOIR LE TABLEAU DE RESISTANCE CHIMIQUE SEL).

ID		OD		WP		BP		VACUUM	BR/r	W	L
inch	mm	mm	mm	bar	psi	bar	psi	bar	mm	g/m	m
3/4"	19	29	10	145	40	580	-0.92	90	565	40-46-61	
1"	25.4	36	10	145	40	580	-0.92	125	760	40-46-61	
1 1/4"	32	44	10	145	40	580	-0.92	160	1080	40-46-61	
1 1/2"	38	50	10	145	40	580	-0.92	195	1235	40-46-61	
2"	50.8	65	10	145	40	580	-0.92	300	1955	40-46-61	
2 1/2"	63.5	78	10	145	40	580	-0.92	400	2325	40-46-61	
3"	76.2	91	10	145	40	580	-0.92	550	2985	40-46-61	
4"	101.6	118	10	145	40	580	-0.92	650	4280	40-46-61	

IMPORTANT : When ordering: Clearly specify working conditions such as characteristics of fluid, concentration and working temperature. Other diameters, pressures, colours, cover type and double steel wire helix can be made upon request.

WICHTIG : Bei Aufträgen bitte Material, Konzentrat und Betriebsdruck genau angeben. Weitere Sonderwünsche wie besondere Abmessungen, Aufdrucktypen, Farben, Aussengummi und Doppelspirale auf Anfrage möglich.

IMPORTANTE : In sede d'ordine specificare: Caratteristiche del fluido, della concentrazione e della temperatura d'esercizio. Altri diametri, pressioni, colori, tipo di copertura e doppio spirale d'acciaio realizzabili su richiesta.



IMPORTANT : Mentionner avec la commande les caracteristiques de la matiere, la concentration et la pression de service. Les autres diametres, pressions, couleurs, type de revetement et double helice acier peuvent etre produits selon la commande.



-40°C / + 80°C
 -40°F / +176°F

MARKING / BESCHRIFTUNG / MARCATURA / MARQUAGE: **TRANSFER TAPE OR EMBOSSED**

SEL KEMI SDC/10 UHMW-PE ACID - SOLVENT AND CHEMICAL S/D UHMW-PE HOSE W.P. 10 Bar (145 PSI)

NORMS NORMEN NORME NORMES	ISO 1307	COLOUR FARBEN COLORI COULEUR	  
------------------------------------	----------	---------------------------------------	--

Acid-Solvent and Chemical Delivery



UHMW-PE EN 12115



TUBE : TRANSLUCENT, FOOD GRADE UHMW-PE LINER SUITABLE FOR WIDE RANGE OF CORROSIVE CHEMICALS AND SOLVENTS.
 REINFORCEMENT : HIGH TENSILE SYNTHETIC TEXTILE AND 2 ANTISTATIC COPPER WIRE.
 COVER : WEATHER, OZONE, ABRASION RESISTANT EPDM RUBBER.
 APPLICATION : FOR DISCHARGE OF ALL CORROSIVE CHEMICALS, ESPECIALLY HIGH AROMATIC SOLVENTS (SEE SEL CHEMICAL RESISTANCE CHART).



SEELE : GEGEN KORROSIVE CHEMIKALIEN UND LÖSUNGSMITTEL BESTÄNDIGER, TRANSPARENTER, LEBENSMITTELECHTER UHMW-PE INLINER.
 EINLAGE : HOCHZUGFESTE SYNTHETISCHE TEXTILEINLAGE UND 2 ANTISTATISCHER KUPFERLITZEN.
 DECKE : OZON- UND WITTERUNGSBESTÄNDIGER, ABRIEBSFESTER EPDM GUMMI.
 ANWENDUNG : DRUCKSCHLAUCH GEEIGNET FÜR VIELE KORROSIVE CHEMIKALIEN, HOCHAROMATISCHE LÖSUNGSMITTEL (SIEHE SEL BESTÄNDIGKEITSLISTE).



SOTTOSTRATO : UHMW-PE - TRANSPARENTE, DI QUALITÀ ALIMENTARE, RESISTENTE AI PRODOTTI CHIMICI ALTAMENTE CORROSIVI E SOLVENTI.
 RINFORZO : INSERZIONI TESSILI AD ALTA TENACITÀ CON 2 CORDICELLE DI RAME ANTISTATICHE.
 COPERTURA : GOMMA IN EPDM RESISTENTE ALL'ABRASIONE, ALL'OZONO ED AGLI AGENTI ATMOSFERICI.
 IMPIEGO : PER MANDATA DI PRODOTTI CHIMICI CORROSIVI, INCLUSI GLI AROMATICI, SOLVENTI ETC. (VEDERE LA TABELLA SEL DELLA RESISTENZA CHIMICA)."



TUBE : UHMW-PE TRANSLUCIDE, DE QUALITE ALIMENTAIRE, RESISTANT AUX PRODUITS CHIMIQUES CORROSIFS.
 RENFORCEMENT : INSERTION TEXTILE HAUTE TENACITE ET 2 FILS DE MASSE ANTISTATIQUES.
 REVETEMENT : CAOUTCHOUC EPDM, RESISTANT A L'ABRASION, A L'OZONE ET AUX AGENTS ATMOSPHERIQUES.
 APPLICATION : POUR REFOULEMENT DE TOUS LES PRODUITS CHIMIQUES CORROSIFS. EN PARTICULIER LES SOLVANTS AROMATIQUES (VOIR LE TABLEAU DE RESISTANCE CHIMIQUE SEL).

ID		OD		WP		BP		BR/r	W	L
inch	mm	mm	mm	bar	psi	bar	psi	mm	g/m	m
3/4"	19	31	16	232	64	928	187	612	40-46-61	
1"	25.4	37	16	232	64	928	225	755	40-46-61	
1 1/4"	32	44	16	232	64	928	262	941	40-46-61	
1 1/2"	38	51	16	232	64	928	338	1196	40-46-61	
2"	50.8	67	16	232	64	928	410	1939	40-46-61	
2 1/2"	63.5	79	16	232	64	928	450	2301	40-46-61	
3"	76.2	92	16	232	64	928	525	2747	40-46-61	
4"	101.6	118	16	232	64	928	675	3785	40-46-61	

IMPORTANT : When ordering: Clearly specify working conditions such as characteristics of fluid, concentration and working temperature. Other diameters, pressures, colours, cover type and double steel wire helix can be made upon request.
WICHTIG : Bei Aufträgen bitte Material, Konzentrat und Betriebsdruck genau angeben. Weitere Sonderwünsche wie besondere Abmessungen, Aufdrucktypen, Farben, Aussengummi und Doppelspirale auf Anfrage möglich.
IMPORTANTE : In sede d'ordine specificare: Caratteristiche del fluido, della concentrazione e della temperatura d'esercizio. Altri diametri, pressioni, colori, tipo di copertura e doppio spirale d'acciaio realizzabili su richiesta.
IMPORTANT : Mentionner avec la commande les caractéristiques de la matière, la concentration et la pression de service. Les autres diamètres, pressions, couleurs, type de revêtement et double hélice acier peuvent être produits selon la commande.



-40°C / + 80°C
 -40°F / +176°F

MARKING / BESCHRIFTUNG / MARCATURA / MARQUAGE: **TRANSFER TAPE OR EMBOSSED**

SEL KEMI D/16 UHMW-PE ACID-SOLVENT AND CHEMICAL DELIVERY HOSE - TS EN 12115 - UHMW-PE - TYPE D - M - W.P. 16 Bar (232 PSI)

NORMS NORMEN NORME NORMES	TS EN 12115 TYPE D	COLOUR FARBEN COLORI COULEUR	
------------------------------------	--------------------	---------------------------------------	--

Acid-Solvent and Chemical S&D

UHMW-PE EN 12115



TUBE : TRANSLUCENT, FOOD GRADE UHMW-PE LINER SUITABLE FOR WIDE RANGE OF CORROSIVE CHEMICALS AND SOLVENTS.
 REINFORCEMENT : HIGH TENSILE SYNTHETIC TEXTILE, STEEL WIRE HELIX AND 2 ANTISTATIC COPPER WIRE.
 COVER : WEATHER, OZONE, ABRASION RESISTANT EPDM RUBBER.
 APPLICATION : FOR SUCTION AND DISCHARGE OF ALL CORROSIVE CHEMICALS, ESPECIALLY HIGH AROMATIC SOLVENTS (SEE SEL CHEMICAL RESISTANCE CHART).



SEELE : GEGEN KORROSIVE CHEMIKALIEN UND LÖSUNGSMITTEL BESTÄNDIGER, TRANSPARENTER, LEBENSMITTELECHTER UHMW-PE INLINER.
 EINLAGE : HOCHZUGFESTE SYNTHETISCHE TEXTILEINLAGE MIT EINER STAHLDRAHTSPIRALE UND 2 ANTISTATISCHE KUPFERLITZEN.
 DECKE : OZON- UND WITTERUNGSBESTÄNDIGER, ABRIEBSFESTER EPDM GUMMI.
 ANWENDUNG : SAUG- DRUCKSCHLAUCH GEEIGNET FÜR VIELE KORROSIVE CHEMIKALIEN, HOCHAROMATISCHE LÖSUNGSMITTEL (SIEHE SEL BESTÄNDIGKEITSLISTE).



SOTTOSTRATO : UHMW-PE - TRANSPARENTE, DI QUALITÀ ALIMENTARE, RESISTENTE AI PRODOTTI CHIMICI ALTAMENTE CORROSIVI E SOLVENTI.
 RINFORZO : INSERZIONI TESSILI AD ALTA TENACITÀ, CON SPIRALE D'ACCIAIO E 2 CORDICELLE DI RAME ANTISTATICHE.
 COPERTURA : GOMMA IN EPDM RESISTENTE ALL'ABRASIONE, ALL'OZONO ED AGLI AGENTI ATMOSFERICI.
 IMPIEGO : PER ASPIRAZIONE E MANDATA DI PRODOTTI CHIMICI CORROSIVI, INCLUSI GLI AROMATICI, SOLVENTI ETC. (VEDERE LA TABELLA SEL DELLA RESISTENZA CHIMICA).



TUBE : UHMW-PE TRANSLUCIDE, DE QUALITE ALIMENTAIRE, RESISTANT AUX PRODUITS CHIMIQUES CORROSIFS.
 RENFORCEMENT : INSERTION TEXTILE HAUTE TENACITE, SPIRALE EN ACIER ET 2 FILS DE MASSE ANTISTATIQUES.
 REVETEMENT : CAOUTCHOUC EPDM, RESISTANT A L'ABRASION, A L'OZONE ET AUX AGENTS ATMOSPHERIQUES.
 APPLICATION : POUR ASPIRATION ET REFOULEMENT DE TOUS LES PRODUITS CHIMIQUES CORROSIFS. EN PARTICULIER LES SOLVANTS AROMATIQUES (VOIR LE TABLEAU DE RESISTANCE CHIMIQUE SEL).

ID		OD	WP		BP		VACUUM	BR/r	W	L
inch	mm	mm	bar	psi	bar	psi	bar	mm	g/m	m
3/4"	19	31	16	232	64	928	-0.92	187	674	40-46-61
1"	25.4	37	16	232	64	928	-0.92	225	826	40-46-61
1 1/4"	32	44	16	232	64	928	-0.92	262	1044	40-46-61
1 1/2"	38	51	16	232	64	928	-0.92	338	1393	40-46-61
2"	50.8	67	16	232	64	928	-0.92	410	2245	40-46-61
2 1/2"	63.5	79	16	232	64	928	-0.92	450	2620	40-46-61
3"	76.2	92	16	232	64	928	-0.92	525	3223	40-46-61
4"	101.6	118	16	232	64	928	-0.92	675	4568	40-46-61

IMPORTANT : When ordering: Clearly specify working conditions such as characteristics of fluid, concentration and working temperature. Other diameters, pressures, colours, cover type and double steel wire helix can be made upon request.

WICHTIG : Bei Aufträgen bitte Material, Konzentrat und Betriebsdruck genau angeben. Weitere Sonderwünsche wie besondere Abmessungen, Aufdrucktypen, Farben, Aussengummi und Doppelspirale auf Anfrage möglich.

IMPORTANTE : In sede d'ordine specificare: Caratteristiche del fluido, della concentrazione e della temperatura d'esercizio. Altri diametri, pressioni, colori, tipo di copertura e doppio spirale d'acciaio realizzabili su richiesta.

IMPORTANT : Mentionner avec la commande les caracteristiques de la matiere, la concentration et la pression de service. Les autres diametres, pressions, couleurs, type de revetement et double helice acier peuvent etre produits selon la commande.



MARKING / BESCHRIFTUNG / MARCATURA / MARQUAGE: **TRANSFER TAPE OR EMBOSSED**

SEL KEMI SD/16 UHMW-PE ACID - SOLVENT AND CHEMICAL S/D HOSE - TS EN 12115 - UHMW-PE - TYPE SD - M - W.P. 16 Bar (232 PSI)

NORMS NORMEN NORME NORMES	TS EN 12115 TYPE SD	COLOUR FARBEN COLORI COULEUR	
------------------------------------	---------------------	---------------------------------------	--

Chemical Hose With Built-in Flanges



TUBE : SPECIAL SYNTHETIC RUBBER, XLPE OR UHMW-PE.
 REINFORCEMENT : HIGH TENSILE SYNTHETIC TEXTILE, STEEL WIRE HELIX AND ANTISTATIC COPPER WIRE.
 COVER : ABRASION, OZONE AND WEATHER RESISTANT SPECIAL SYNTHETIC RUBBER.
 APPLICATION : FOR SUCTION AND DISCHARGE OF CHEMICAL PRODUCTS.



SEELE : SPEZIELLER SYNTHETISCHER GUMMI, XLPE ODER UHMW-PE.
 EINLAGE : HOCHZUGFESTE SYNTHETISCHE TEXTILEINLAGE MIT EINER STAHLDRAHTSPIRALE UND ANTISTATISCHER KUPFERLITZE.
 DECKE : OZON- UND WITTERUNGSBESTÄNDIGER, ABRIEBSFESTER SPEZIELLER SYNTHETISCHER GUMMI.
 ANWENDUNG : SAUG - DRUCKSCHLAUCH FÜR CHEMIKALIEN (SIEHE SEL BESTÄNDIGKEITSLISTE).



SOTTOSTRATO : GOMMA SPECIALE SINTETICA, XLPE O UHMW-PE.
 RINFORZO : INSERZIONI TESSILI AD ALTA TENACITÀ CON SPIRALE D'ACCIAIO E CORDICELLA DI RAME ANTISTATICA.
 COPERTURA : GOMMA SPECIALE SINTETICA RESISTENTE ALL'ABRASIONE, ALL'OZONO ED AGLI AGENTI ATMOSFERICI.
 IMPIEGO : PER ASPIRAZIONE E MANDATA DI PRODOTTI CHIMICI.



TUBE : CAOUTCHOUC SYNTHETIQUE SPECIAL, XLPE OU UHMW-PE.
 RENFORCEMENT : INSERTION TEXTILE HAUTE TENACITE, SPIRALE EN ACIER ET FIL DE MASSE ANTISTATIQUE.
 REVETEMENT : CAOUTCHOUC SYNTHETIQUE SPECIAL, RESISTANT A L'ABRASION, A L'OZONE ET AUX AGENTS ATMOSPHERIQUES.
 APPLICATION : POUR ASPIRATION ET REFOULEMENT DE PRODUITS CHIMIQUES.

ID		OD		WP		BP		VACUUM	BR/r	W	L
inch	mm	mm	bar	psi	bar	psi	bar	mm	g/m	m	
2"	50.8	72	10	145	40	580	-0.80	200	3500	6 ~ 40	
3"	76.2	100	10	145	40	580	-0.80	400	5560	6 ~ 40	
4"	101.6	129	10	145	40	580	-0.80	500	7970	6 ~ 40	
5"	127	162	10	145	40	580	-0.80	650	14070	6 ~ 40	
6"	152.4	190	10	145	40	580	-0.80	750	17325	6 ~ 40	
8"	203	243	10	145	40	580	-0.80	950	24150	6 ~ 12	
10"	254	302	10	145	40	580	-0.80	1200	38630	6 ~ 12	
12"	305.8	356	10	145	40	580	-0.80	1500	48500	6 ~ 12	
14"	355.6	408	10	145	40	580	-0.80	2150	60000	6 ~ 12	
16"	406	460	10	145	40	580	-0.80	2800	72500	6 ~ 12	

IMPORTANT : When ordering: Clearly specify working conditions such as characteristics of fluid, concentration and working temperature.
 Other diameters, pressures, colours, cover type and double steel wire helix can be made upon request.

WICHTIG : Bei Aufträgen bitte Material, Konzentrat und Betriebsdruck genau angeben. Weitere Sonderwünsche wie besondere Abmessungen, Aufdrucktypen, Farben, Aussengummi und Doppelspirale auf Anfrage möglich.

IMPORTANTE : In sede d'ordine specificare: Caratteristiche del fluido, della concentrazione e della temperatura d'esercizio.
 Altri diametri, pressioni, colori, tipo di copertura e doppio spirale d'acciaio realizzabili su richiesta.

IMPORTANT : Mentionner avec la commande les caracteristiques de la matiere, la concentration et la pression de service.
 Les autres diametres, pressions, couleurs, type de revetement et double helice acier peuvent etre produits selon la commande.

NOTES ON ORDERING

- A - Inside diameter
- B - Length (Overall Length)
- C - Working pressure
- D - Type ends or end fittings
- E - Applications (Much detail as possible)
- F - Working temperature

BEMERKUNGEN ZUM AUFTRAG

- A - Innendurchmesser
- B - Schlauchlänge F-F
- C - Betriebsdruck
- D - Flanschbezeichnung
- E - Einsatzbedingungen (Möglichst viele information angeben)
- F - Betriebstemperatur

NOTE ORDINI

- A - Diametro interno
- B - Lunghezza (Flange Incluso)
- C - Pressione di lavoro
- D - Specificazioni per le flange
- E - Applicazione (Massimo dettagli possibile)
- F - Temperatura di lavoro

PRECISIONS NECESSAIRES

- A - Diametre interieur
- B - Longueur (Brides incluses)
- C - Pression de service
- D - Specificaions des brides
- E - Applications (Plus de details possible)
- F - Temperature de travail



-40°C / + 65°C
 -40°F / +149°F

MARKING / BESCHRIFTUNG / MARCATURA / MARQUAGE: **TRANSFER TAPE OR EMBOSSED**



NORMS NORMEN NORME NORMES	ISO 1307	COLOUR FARBEN COLORI COULEUR	
------------------------------------	----------	---------------------------------------	--

Chemical Hose with Rubber Beaded-End With Flange



TUBE : CORROSION AND ABRASION RESISTANT, SPECIAL SYNTHETIC RUBBER, XLPE OR UHMW-PE.
 REINFORCEMENT : HIGH TENSILE SYNTHETIC TEXTILE, STEEL WIRE HELIX AND ANTISTATIC COPPER WIRE.
 COVER : ABRAISON, OZONE AND WEATHER RESISTANT, SPECIAL SYNTHETIC RUBBER.
 APPLICATION : FOR SUCTION AND DISCHARGE OF ALL CORROSIVE CHEMICALS AND SOLVENTS.



SEELE : SPEZIELLER SYNTHETISCHER GUMMI, XLPE ODER UHMW-PE, BESTÄNDIG GEGEN KORROSIVE UND ABRASIVE CHEMIKALIEN.
 EINLAGE : HOCHZUGFESTE SYNTHETISCHE TEXTILEINLAGE MIT EINER STAHLDRAHTSPIRALE UND ANTISTATISCHER KUPFERLITZE.
 DECKE : OZON- UND WITTERUNGSBESTÄNDIGER, ABRIEBSFESTER SPEZIELLER SYNTHETISCHER GUMMI.
 ANWENDUNG : SAUG - DRUCKSCHLAUCH FÜR KORROSIVE UND ABRASIVE CHEMIKALIEN (SIEHE SEL BESTÄNDIGKEITSLISTE).



SOTTOSTRATO : GOMMA SPECIALE SINTETICA, XLPE O UHMW-PE, RESISTENTE ALLA CORROSIONE E ALL' ABRASIONE.
 RINFORZO : INSERZIONI TESSILI AD ALTA TENACITÀ CON SPIRALE D'ACCIAIO E CORDICELLA DI RAME ANTISTATICA.
 COPERTURA : GOMMA SPECIALE SINTETICA RESISTENTE ALL'ABRASIONE, ALL'OZONO ED AGLI AGENTI ATMOSFERICI.
 IMPIEGO : PER ASPIRAZIONE E MANDATA DI PRODOTTI CHIMICI CORROSIVI E SOLVENTI.



TUBE : CAOUTCHOUC SYNTHETIQUE SPECIAL, XLPE OU UHMW-PE, RESISTANT A LA CORROSION ET L'ABRASION.
 RENFORCEMENT : INSERTION TEXTILE HAUTE TENACITE, SPIRALE EN ACIER ET FIL DE MASSE ANTISTATIQUE.
 REVETEMENT : CAOUTCHOUC SYNTHETIQUE SPECIAL, RESISTANT A L'ABRASION, A L'OZONE ET AUX AGENTS ATMOSPHERIQUES.
 APPLICATION : POUR ASPIRATION ET REFOULEMENT DE TOUS LES PRODUITS CORROSIFS CHIMIQUES ET SOLVANTS.

ID		OD	WP		BP		VACUUM	BR/r	W	L
inch	mm	mm	bar	psi	bar	psi	bar	mm	g/m	m
3 1/8"	80	103	10	145	40	580	-0.80	350	4150	1.5 ~ 20
4"	101.6	126	10	145	40	580	-0.80	500	5595	1.5 ~ 20
5"	127	155	10	145	40	580	-0.80	600	8170	1.5 ~ 20
6"	152.4	183	10	145	40	580	-0.80	750	10460	1.5 ~ 20
8"	203	236	10	145	40	580	-0.80	1100	15350	1.5 ~ 20
10"	254	291	10	145	40	580	-0.80	1500	20750	1.5 ~ 10
12"	298	336	10	145	40	580	-0.80	1800	26100	1.5 ~ 10

IMPORTANT : When ordering: Clearly specify working conditions such as characteristics of fluid, concentration and working temperature.
 Other diameters, pressures, colours, cover type and double steel wire helix can be made upon request.

WICHTIG : Bei Aufträgen bitte Material, Konzentrat und Betriebsdruck genau angeben. Weitere Sonderwünsche wie besondere Abmessungen, Aufdrucktypen, Farben, Aussengummi und Doppelspirale auf Anfrage möglich.

IMPORTANTE : In sede d'ordine specificare: Caratteristiche del fluido, della concentrazione e della temperatura d'esercizio.
 Altri diametri, pressioni, colori, tipo di copertura e doppio spirale d'acciaio realizzabili su richiesta.

IMPORTANT : Mentionner avec la commande les caracteristiques de la matiere, la concentration et la pression de service.
 Les autres diametres, pressions, couleurs, type de revetement et double helice acier peuvent etre produits selon la commande.

NOTES ON ORDERING

A - Inside diameter
 B - Length (Overall Length)
 C - Working pressure
 D - Type ends or end fittings
 E - Applications (Much detail as possible)
 F - Working temperature

BEMERKUNGEN ZUM AUFTRAG

A - Innendurchmesser
 B - Schlauchlänge F-F
 C - Betriebsdruck
 D - Flanschbezeichnung
 E - Einsatzbedingungen (Möglichst viele information angeben)
 F - Betriebstemperatur

NOTE ORDINI

A - Diametro interno
 B - Lunghezza (Flange Incluso)
 C - Pressione di lavoro
 D - Specificazioni per le flange
 E - Applicazione (Massimo dettagli possibile)
 F - Temperatura di lavoro

PRECISIONS NECESSAIRES

A - Diametre interieur
 B - Longueur (Brides incluses)
 C - Pression de service
 D - Specificaions des brides
 E - Applications (Plus de details possible)
 F - Temperature de travail



-40°C / + 65°C
 -40°F / +149°F

MARKING / BESCHRIFTUNG / MARCATURA / MARQUAGE: **TRANSFER TAPE OR EMBOSSED**



NORMS NORMEN NORME NORMES	FLANGES NORM: PN 10 PN 16	COLOUR FARBEN COLORI COULEUR	
------------------------------------	---------------------------------	---------------------------------------	--



Cable Protection

Kabelschutz

Protezione Cavi

Gaines de Protections



Cable Protection for Electrical Welding



TUBE : RUBBERIZED SYNTHETIC TEXTILE
 COVER : ABRASION AND WEATHER RESISTANT, BLACK, NON-CONDUCTIVE, SYNTHETIC RUBBER
 APPLICATION : CABLE PROTECTION IN INDUSTRIAL APPLICATIONS AND WELDING MACHINES.



SEELE : KAUSCHUK MIT SYNTHETISCHER TEXTILEINKLAGE.
 DECKE : ABRIEB-, UND WITTERUNGSBESTÄNDIG SCHWARZES SYNTHETISCHES-GUMMI, ISOLIEREND.
 ANWENDUNG : SCHÜTZT INDUSTRIESCHLÄUCHE IN INDUSTRIE UND SCHWEIßBEREICHEN.



SOTTOSTRATO : TESSUTO SINTETICO GOMMATO.
 COPERTURA : GOMMA SPECIALE SINTECITA, NERA, NON CONDUTTIVA RESISTENTE ALL'ABRASIONE ED AGLI AGENTI ATMOSFERICI.
 IMPIEGO : PER RIVESTIMENTO DEI CAVI ELETTRICI PER APPLICAZIONI INDUSTRIALI E NELLE MACCHINE SALDATRICI.



TUBE : TEXTILE SYNTHETIQUE IMPREGNE DE CAOUTCHOUC.
 REVETEMENT : CAOUTCHOUC SYNTHETIQUE NON-CONDUCTEUR, NOIR, RESISTANT A L'ABRASION ET AUX AGENTS ATMOSPHERIQUES.
 APPLICATION : PROTECTION DE CABLES ELECTRIQUES POUR L'INDUSTRIE ET LES MACHINES DE SOUDAGE.

ID		OD	WP		BP		BR/r	W	L
inch	mm	mm	bar	psi	bar	psi	mm	g/m	m
5/8"	16	19	-	-	-	-	-	96	61
3/4"	19	22	-	-	-	-	-	111	61
-	20	23	-	-	-	-	-	100	61
7/8"	22	25	-	-	-	-	-	106	61
1"	25.4	27.4	-	-	-	-	-	124	61
1 1/8"	28	31	-	-	-	-	-	131	61
1 3/16"	30	33	-	-	-	-	-	143	61
1 1/4"	32	35	-	-	-	-	-	164	61
1 3/8"	35	38	-	-	-	-	-	180	61
1 1/2"	38	41	-	-	-	-	-	192	61
1 9/16"	40	43	-	-	-	-	-	204	61
1 5/8"	42	45	-	-	-	-	-	222	61
1 3/4"	44.5	48	-	-	-	-	-	240	61
2"	50.8	54	-	-	-	-	-	253	61
	54	57	-	-	-	-	-	265	61
2 1/8"	55	58	-	-	-	-	-	280	61
2 1/4"	57	60	-	-	-	-	-	319	61



-30°C / + 80°C
 -22°F / +176°F

NORMS
 NORMEN
 NORME
 NORMES

ISO 1307

COLOUR
 FARBEN
 COLORI
 COULEUR



Cable Protection for Electrical Welding



CONSTRUCTION : SYNTHETIC FULLENO.
 ABRASION AND WEATHER RESISTANT, BLACK, NON-CONDUCTIVE, SYNTHETIC RUBBER
 APPLICATION : CABLE PROTECTION IN INDUSTRIAL APPLICATIONS AND WELDING MACHINES.



KONSTRUKTION : SYNTHETISCHES FULLENO.
 ABRIEB-, UND WITTERUNGSBESTÄNDIG SCHWARZES SYNTHETISCHES-GUMMI, ISOLIEREND.
 ANWENDUNG : SCHÜTZT INDUSTRIESCHLÄUCHE IN INDUSTRIE UND SCHWEIßBEREICHEN.



COSTRUZIONE : SINTETICO FULLENO.
 GOMMA SPECIALE SINTECITA, NERA, NON CONDUTTIVA RESISTENTE ALL'ABRASIONE ED AGLI AGENTI ATMOSFERICI.
 IMPIEGO : PER RIVESTIMENTO DEI CAVI ELETTRICI PER APPLICAZIONI INDUSTRIALI E NELLE MACCHINE SALDATRICI.



CONSTRUCTION : TEXTILE SYNTHETIQUE FULLENO.
 CAOUTCHOUC SYNTHETIQUE NON-CONDUCTEUR, NOIR, RESISTANT A L'ABRASION ET AUX AGENTS ATMOSPHERIQUES.
 APPLICATION : PROTECTION DE CABLES ELECTRIQUES POUR L'INDUSTRIE ET LES MACHINES DE SOUDAGE.

ID		OD	WP		BP		BR/r	W	L
inch	mm	mm	bar	psi	bar	psi	mm	g/m	m
-	14	16	-	-	-	-	-	62	61
-	18	20	-	-	-	-	-	78	61
-	20	22	-	-	-	-	-	86	61
7/8"	22	24	-	-	-	-	-	95	61
-	24	26	-	-	-	-	-	103	61
1"	25.4	27.4	-	-	-	-	-	109	61
1 1/8"	28	30	-	-	-	-	-	120	61
1 1/4"	32	34	-	-	-	-	-	136	61
1 3/8"	35	37	-	-	-	-	-	148	61
1 9/16"	40	42	-	-	-	-	-	169	61
1 3/4"	44.5	46.5	-	-	-	-	-	243	61
1 7/8"	48	50	-	-	-	-	-	202	61



-30°C / + 80°C
 -22°F / +176°F

NORMS
 NORMEN
 NORME
 NORMES

ISO 1307

COLOUR
 FARBEN
 COLORI
 COULEUR



Electrical Cable Protection for Trains



TUBE : BLACK, NON-CONDUCTIVE, SYNTHETIC RUBBER.
 REINFORCEMENT : SYNTHETIC FULLENO.
 COVER : ABRASION AND WEATHER RESISTANT, BLACK, NON-CONDUCTIVE, SYNTHETIC RUBBER
 APPLICATION : CABLE PROTECTION IN INDUSTRIAL APPLICATIONS AND RAILWAY.



SEELE : SCHWARZES SYNTHETISCHES-GUMMI, ISOLIEREND.
 EINLAGEN : SYNTHETISCHES FULLENO.
 DECKE : ABRIEB-, UND WITTERUNGSBESTÄNDIG SCHWARZES SYNTHETISCHES-GUMMI, ISOLIEREND.
 ANWENDUNG : SCHÜTZT INDUSTRIESCHLÄUCHE IN INDUSTRIE UND EISENBAHN.



SOTTOSTRATO : GOMMA SPECIALE SINTECITA, NERA, NON CONDUTTIVA.
 RINFORZO : SINTETICO FULLENO.
 COPERTURA : GOMMA SPECIALE SINTECITA, NERA, NON CONDUTTIVA RESISTENTE ALL'ABRASIONE ED AGLI AGENTI ATMOSFERICI.
 IMPIEGO : PER RIVESTIMENTO DEI CAVI ELETTRICI PER APPLICAZIONI INDUSTRIALI E FERROVIE.



TUBE : CAOUTCHOUC SYNTHETIQUE NON-CONDUCTEUR, NOIR.
 RENFORCEMENT : TEXTILE SYNTHETIQUE FULLENO.
 REVETEMENT : CAOUTCHOUC SYNTHETIQUE NON-CONDUCTEUR, NOIR, RESISTANT A L'ABRASION ET AUX AGENTS ATMOSPHERIQUES.
 APPLICATION : PROTECTION DE CABLES ELECTRIQUES POUR L'INDUSTRIELLE ET LES CHEMINS DE FER.

ID		OD	WP		BP		BR/r	W	L
inch	mm	mm	bar	psi	bar	psi	mm	g/m	m
13/32"	10	14	-	-	-	-	-	119	40-46-61
	12	17	-	-	-	-	-	170	40-46-61
1/2"	12.7	18	-	-	-	-	-	187	40-46-61
	14	19	-	-	-	-	-	194	40-46-61
	15	20	-	-	-	-	-	206	40-46-61
5/8"	16	21	-	-	-	-	-	218	40-46-61
	17	22	-	-	-	-	-	230	40-46-61
	18	23	-	-	-	-	-	242	40-46-61
3/4"	19	24	-	-	-	-	-	253	40-46-61
	20	25	-	-	-	-	-	265	40-46-61
7/8"	22	27	-	-	-	-	-	246	40-46-61
	24	29	-	-	-	-	-	313	40-46-61
1"	25.4	30	-	-	-	-	-	329	40-46-61
1 1/8"	28.6	33	-	-	-	-	-	360	40-46-61
1 1/6"	30	35	-	-	-	-	-	384	40-46-61
1 1/4"	32	37	-	-	-	-	-	408	40-46-61
1 3/8"	35	40	-	-	-	-	-	443	40-46-61
1 9/16"	40	45	-	-	-	-	-	503	40-46-61
1 5/8"	42	47	-	-	-	-	-	526	40-46-61
1 3/4"	45	50	-	-	-	-	-	556	40-46-61
1 7/8"	48	53	-	-	-	-	-	598	40-46-61
2"	50.8	56	-	-	-	-	-	657	40-46-61
2 1/4"	57	63	-	-	-	-	-	881	40-46-61
2 3/8"	60	66	-	-	-	-	-	894	40-46-61
2 3/4"	70	76	-	-	-	-	-	1036	40-46-61
3 1/8"	80	87	-	-	-	-	-	1422	40-46-61



-30°C / + 80°C
 -22°F / +176°F

NORMS : FS 304188
 NORMEN : EN ISO 11925-2
 NORME : ASTM C542
 NORMES : ISO 1307

COLOUR :
 FARBEN :
 COLORI :
 COULEUR :



Mining Conduit Hose (non reinforced)



CONSTRUCTION : FLAME RESISTANT AND NON-CONDUCTIVE BLACK CR RUBBER.
APPLICATION : FOR ELECTRICAL CABLE PROTECTION IN MINES AND ON MINING EQUIPMENT.



KONSTRUKTION : SCHWARZES, BRANDFESTES CR-GUMMI, ISOLIEREND.
ANWENDUNG : SCHÜTZT INDUSTRIESCHLÄUCHE IN BERGBAU.



COSTRUZIONE : GOMMA SPECIALE CR, NERA, NON CONDUTTIVA RESISTENTE ALLA FIAMMA
IMPIEGO : PER RIVESTIMENTO DEI CAVI ELETTRICI NELLE MINIERE E ATTREZZATURA MINERARIA



CONSTRUCTION : CAOUTCHOUC CR, NOIR, NON-CONDUCTEUR, RESISTANT A LA FLAMME.
APPLICATION : POUR PROTECTION DE CABLES ELECTRIQUES DANS LES MINES ET LES EQUIPEMENTS MINIERES.

ID		OD	WP		BP		BR/r	W	L
inch	mm	mm	bar	psi	bar	psi	mm	g/m	m
13/32"	10	20	-	-	-	-	-	327	61
1/2"	12.7	23.5	-	-	-	-	-	409	61
5/8"	16	27	-	-	-	-	-	484	61
3/4"	19	30	-	-	-	-	-	552	61
7/8"	22	33	-	-	-	-	-	634	61
1"	25.4	36	-	-	-	-	-	697	61
1 1/8"	28.6	39.5	-	-	-	-	-	789	61
1 1/4"	32	42.5	-	-	-	-	-	829	61
1 3/8"	35	46	-	-	-	-	-	914	61
1 1/2"	38	49	-	-	-	-	-	982	61
1 3/4"	45	55	-	-	-	-	-	1118	61
2"	50.8	61.5	-	-	-	-	-	1272	61
2 1/4"	57	68	-	-	-	-	-	1441	61
2 3/8"	60	71	-	-	-	-	-	1510	61
2 1/2"	63.5	74.5	-	-	-	-	-	1560	61
3"	76.2	87	-	-	-	-	-	1848	61

- * MEETS MSHA 2G-1C-34/3 FLAME-RESISTANT REQUIREMENTS.
- * ENTSPRICHT DEN MSHA 2G-1C-34/3 FLAMMBESTAENDIGKEITSANFORDERUNGEN.
- * SODDISFA REQUISITI MSHA 2G-1C-34/3 DI RESISTENZA AL FUOCO.
- * REpond AUX EXIGENCES MSHA 2G-1C-34/3 RESISTANCE A LA FLAMME.



-30°C / + 80°C
-22°F / +176°F

NORMS NORMEN NORME NORMES	ISO 1307	COLOUR FARBEN COLORI COULEUR	
------------------------------------	----------	---------------------------------------	--

Mining Conduit Hose (reinforced)



 TUBE : FLAME RESISTANT AND NON-CONDUCTIVE BLACK CR RUBBER.
 REINFORCEMENT : HIGH TENSILE SYNTHETIC TEXTILE.
 COVER : FLAME RESISTANT AND NON-CONDUCTIVE BLACK CR RUBBER
 APPLICATION : FOR ELECTRICAL CABLE PROTECTION IN MINES AND ON MINING EQUIPMENT.

 SEELE : SCHWARZES, BRANDFESTES CR-GUMMI, ISOLIEREND.
 EINLAGEN : HOCHZUGFESTE SYNTHETISCHE TEXTILEINLAGE.
 DECKE : SCHWARZES, BRANDFESTES CR-GUMMI, ISOLIEREND.
 ANWENDUNG : SCHÜTZT INDUSTRIESCHLÄUCHE IN BERGBAU.

 SOTTOSTRATO : GOMMA SPECIALE CR, NERA, NON CONDUTTIVA RESISTENTE ALLA FIAMMA
 RINFORZO : INSERZIONI TESSILI AD ALTA TENACITÀ
 COPERTURA : GOMMA SPECIALE CR, NERA, NON CONDUTTIVA RESISTENTE ALLA FIAMMA
 IMPIEGO : PER RIVESTIMENTO DEI CAVI ELETTRICI NELLE MINIERE E Attrezzatura mineraria

 TUBE : CAOUTCHOUC CR, NOIR, NON-CONDUCTEUR, RESISTANT A LA FLAMME.
 RENFORCEMENT : INSERTION TEXTILE HAUTE TENACITE
 REVETEMENT : CAOUTCHOUC CR, NOIR, NON-CONDUCTEUR, RESISTANT A LA FLAMME.
 APPLICATION : POUR PROTECTION DE CABLES ELECTRIQUES DANS LES MINES ET LES EQUIPEMENTS MINIERES.

ID		OD	WP		BP		BR/r	W	L
inch	mm	mm	bar	psi	bar	psi	mm	g/m	m
1/2"	12.7	24	-	-	-	-	-	396	61
5/8"	16	27	-	-	-	-	-	444	61
3/4"	19	30	-	-	-	-	-	506	61
7/8"	22	33	-	-	-	-	-	568	61
1"	25.4	36	-	-	-	-	-	639	61
1 1/8"	28	40	-	-	-	-	-	767	61
1 1/4"	32	43	-	-	-	-	-	776	61
1 3/8"	35	46	-	-	-	-	-	838	61
1 1/2"	38	49	-	-	-	-	-	900	61
1 3/4"	45	56	-	-	-	-	-	1128	61
2"	50.8	61.5	-	-	-	-	-	1165	61
2 1/4"	57	68	-	-	-	-	-	1294	61
2 3/8"	60	71	-	-	-	-	-	1356	61
2 1/2"	63.5	74.5	-	-	-	-	-	1428	61
3"	76.2	87	-	-	-	-	-	1619	61
4"	101.6	113	-	-	-	-	-	2218	61

- * MEETS MSHA 2G-1C-34/3 FLAME-RESISTANT REQUIREMENTS.
- * ENTSPRICHT DEN MSHA 2G-1C-34/3 FLAMMBESTAENDIGKEITSANFORDERUNGEN.
- * SODDISFA REQUISITI MSHA 2G-1C-34/3 DI RESISTENZA AL FUOCO.
- * REpond AUX EXIGENCES MSHA 2G-1C-34/3 RESISTANCE A LA FLAMME.



NORMS NORMEN NORME NORMES	ISO 1307	COLOUR FARBEN COLORI COULEUR	
------------------------------------	----------	---------------------------------------	--

Insulating Hose for Cable



TUBE : INSULATING WHITE EPDM RUBBER.
 REINFORCEMENT : HIGH TENSILE SYNTHETIC TEXTILE.
 COVER : ABRASION, HEAT, OZONE AND WEATHER RESISTANT INSULATING EPDM RUBBER.
 APPLICATION : TO COOL AND PROTECT ELECTRICAL CABLES IN STEEL MILLS AND FOUNDRIES.



SEELE : EPDM-GUMMI, ISOLIEREND.
 EINLAGEN : HOCHZUGFESTE TEXTILEINLAGE.
 DECKE : ABRIEB-, WÄRME-, OZON- UND WITTERUNGSBESTÄNDIG EPDM-GUMMI, ISOLIEREND.
 ANWENDUNG : KÜHLT UND SCHÜTZT INDUSTRIESCHLÄUCHE IN GIEßBEREICHEN SOWIE STAHLWERKEN MIT HOHEN UMGEBUNGSTEMPERATUREN.



SOTTOSTRATO : GOMMA BIANCA IN EPDM, ISOLANTE.
 RINFORZO : INSERZIONI TESSILI AD ALTA TENACITÀ
 COPERTURA : GOMMA IN EPDM ISOLANTE, RESISTENTE AL CALORE, ALL'ABRASIONE, ALL'OZONO ED AGLI AGENTI ATMOSFERICI.
 IMPIEGO : PER PROTEZIONE ET RAFFREDDAMENTO DI CAVI ELETTRICI NELLE ACCIAIERIE E FONDERIE.



TUBE : CAOUTCHOUC EPDM BLANC, ISOLANT.
 REINFORCEMENT : INSERTION TEXTILE HAUTE TENACITE.
 REVETEMENT : CAOUTCHOUC EPDM ISOLANT, RESISTANT A L'ABRASION, A LA CHALEUR, A L'OZONE ET AUX AGENTS ATMOSPHERIQUES.
 APPLICATION : REFROIDISSEMENT DES CABLES DE HAUTES-FOURNEAUX DANS LES ACIERIES ET LES FONDERIES.

ID		OD	WP		BP		W	L
inch	mm	mm	bar	psi	bar	psi	g/m	m
1/2"	12.7	22	10	145	30	435	390	40-46-61
3/4"	19	32	10	145	30	435	765	40-46-61
1"	25.4	38	10	145	30	435	910	40-46-61
1 1/4"	32	47	10	145	30	435	1355	40-46-61
1 1/2"	38	54	10	145	30	435	1695	40-46-61
1 3/4"	44.5	60.5	10	145	30	435	1950	40-46-61
2"	50.8	69	10	145	30	435	2540	40-46-61
2 1/2"	63.5	80	10	145	30	435	2770	40-46-61
3"	76.2	94	10	145	30	435	3640	40-46-61

: $\geq 1 \times 10^{12} \Omega/m$



-40°C / +125°C
 -40°F / +257°F

NORMS
 NORMEN
 NORME
 NORMES

ISO 1307

COLOUR
 FARBEN
 COLORI
 COULEUR



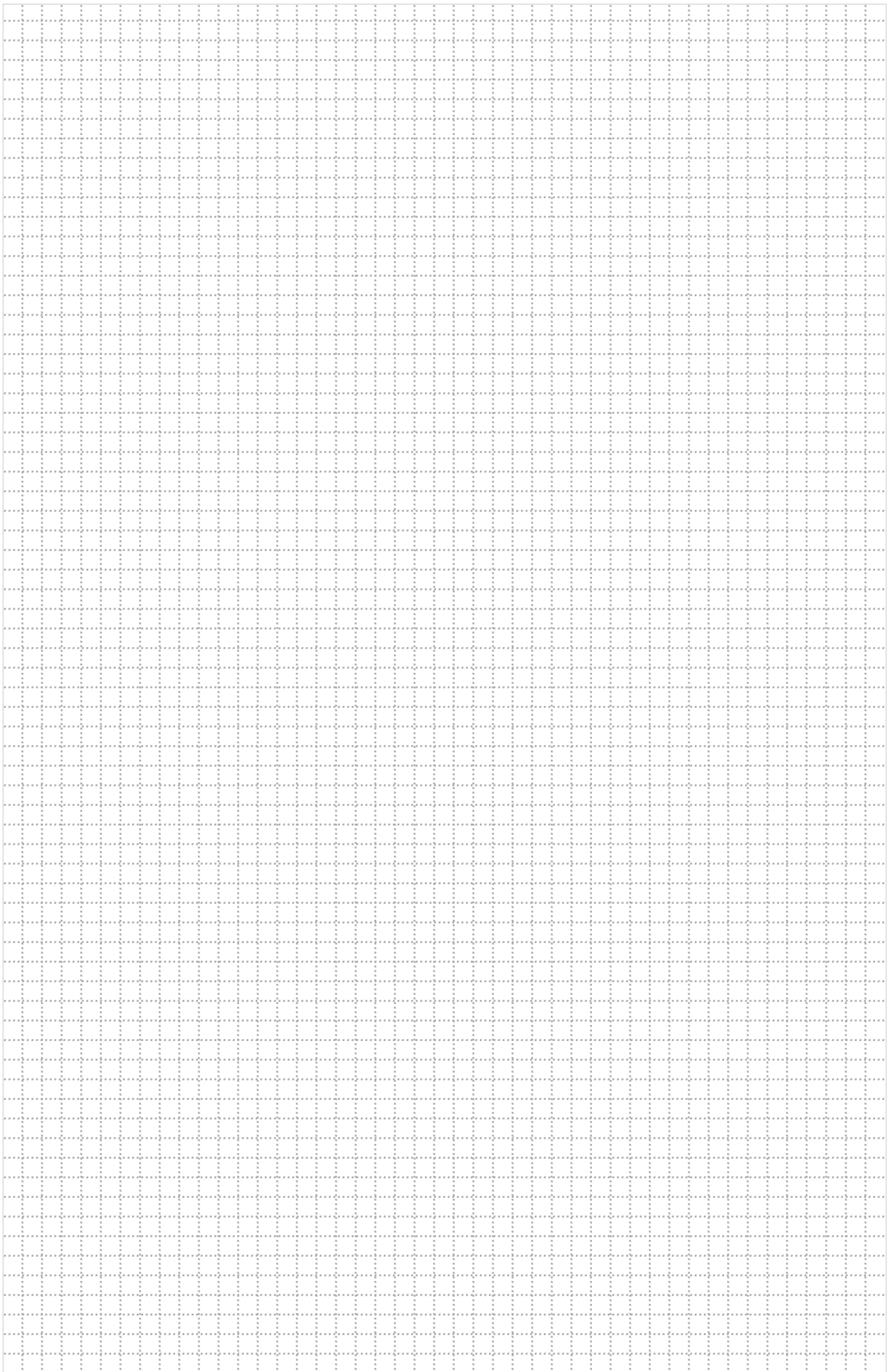

Steel Mill

Stahlwerk

Acciaieria

Aciérie

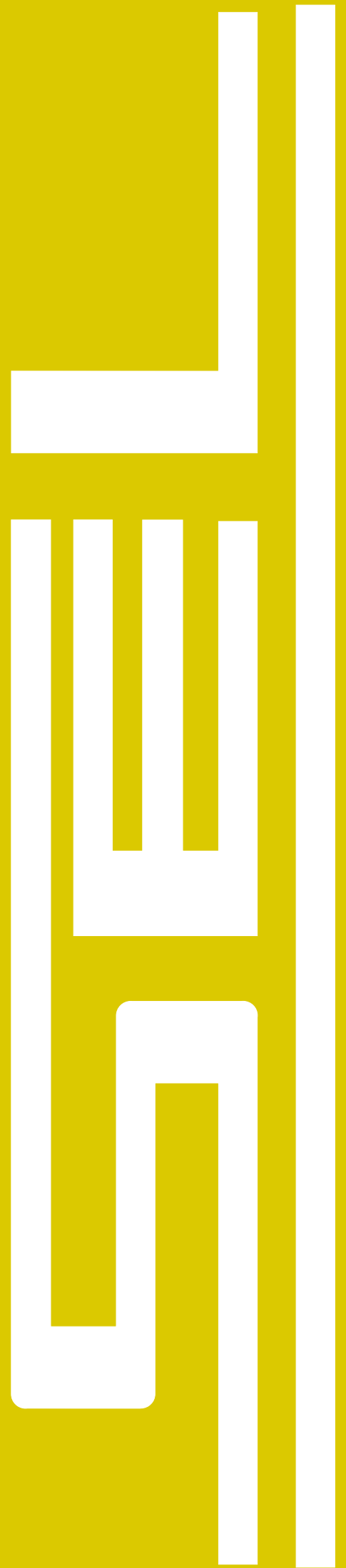
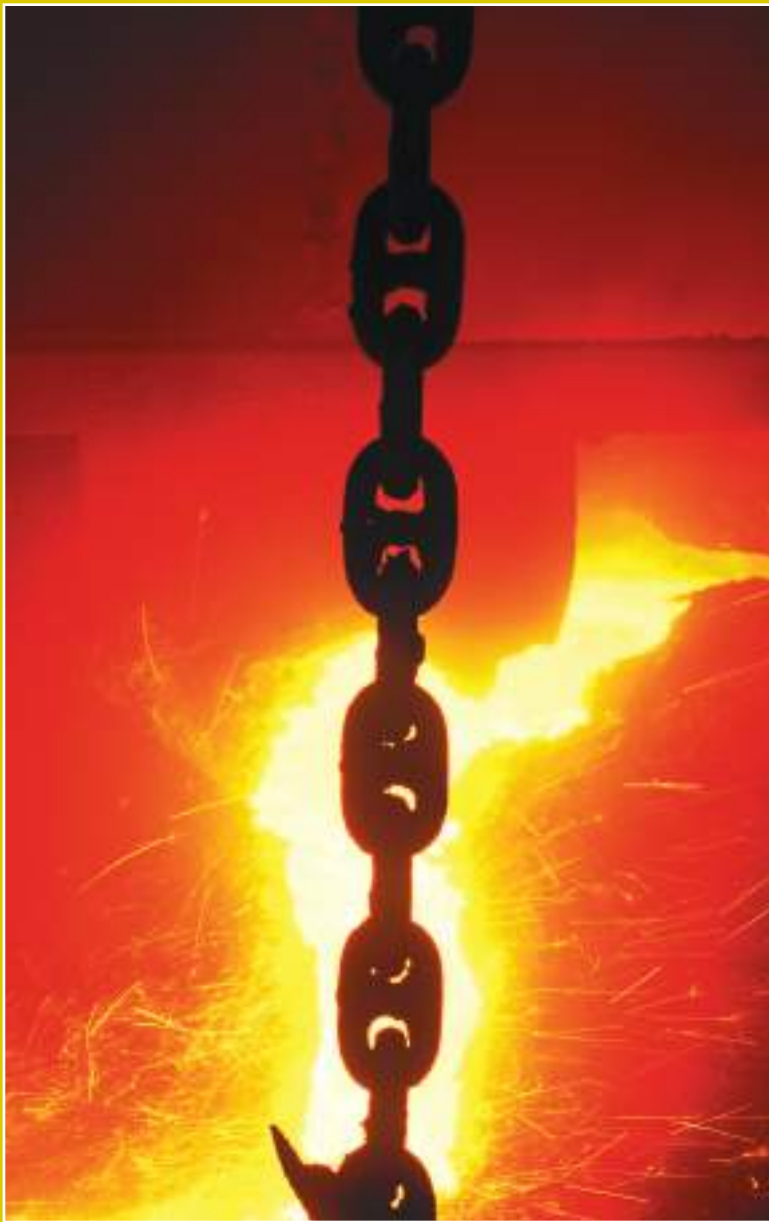

Carbon Blower Hose



TUBE : ABRASION RESISTANT, ANTISTATIC NR.
 REINFORCEMENT : HIGH TENSILE SYNTHETIC TEXTILE STEEL WIRE HELIX AND ANTISTATIC COPPER WIRE.
 COVER : ABRASION, OZONE AND WEATHER RESISTANT PIN-PRICKED SPECIAL SYNTHETIC RUBBER.
 APPLICATION : FOR CARBON BLOWER APPLICATIONS IN STEEL MILLS AND FOUNDRIES.



SEELE : ABRIEFESTES, LEITFÄHIGES NATUR KAUTSCHUK.
 EINLAGEN : HOCHZUGFESTE SYNTHETISCHE TEXTILEINLAGE MIT EINER STAHLDRAHT SPIRALE UND ANTISTATISCHER KUPFERDRAHT.
 DECKE : ABRIEB-, OZON- UND WITTERUNGSBESTÄNDIG SPEZIELLES GEPRICKTES SYNTHETISCHES-GUMMI.
 ANWENDUNG : FÜR CARBON LÜFTUNGEN IN GIEßEREIEN SOWIE STAHLWERKEN.



SOTTOSTRATO : GOMMA NATURALE ANTISTATICA, RESISTENTE ALL'ABRASIONE.
 RINFORZO : INSERZIONI TESSILI AD ALTA TENACITÀ CON SPIRALE D'ACCIAIO E CORDICELLA DI RAME ANTISTATICA.
 COPERTURA : GOMMA NATURAL E SINTETICA MICRO-FORATA, RESISTENTE ALL'ABRASIONE, ALL'OZONO ED AGLI AGENTI ATMOSFERICI.
 IMPIEGO : PER PROIEZIONE DI CARBONE NELLE ACCIAIERIE E FONDERIE.



TUBE : CAOUTCHOUC NATUREL CONDUCTEUR, RESISTANT A L'ABRASION.
 RENFORCEMENT : INSERTION TEXTILE HAUTE TENACITE SPIRALE EN ACIER ET FIL DE MASSE ANTISTATIQUE.
 REVETEMENT : CAOUTCHOUC SYNTHETIQUE ET NATUREL, MICRO-PERFORE, RESISTANT A L'ABRASION, A L'OZONE ET AUX AGENTS ATMOSPHERIQUES.
 APPLICATION : POUR LA PROJECTION DE CARBONE DANS LES ACIERIES ET FONDERIES.

ID		OD	WP		BP		W	L
inch	mm	mm	bar	psi	bar	psi	g/m	m
1 1/4"	32	62	10	145	30	435	2750	40-46-61
1 1/2"	38	68	10	145	30	435	3455	40-46-61
2"	50.8	80	10	145	30	435	3875	40-46-61
2 1/2"	63.5	95	10	145	30	435	5450	40-46-61

Abrasion loss value: Acc DIN 53516 $\leq 35 \text{ mm}^3$
 Abriebwert nach DIN 53516 $\leq 35 \text{ mm}^3$
 Perdita d'abrasione in accordo alla norma DIN 53516 $\leq 35 \text{ mm}^3$
 Indice d'abrasion: Selon la norme DIN 53516 $\leq 35 \text{ mm}^3$



-40°C /+ 70°C
 -40°F /+158°F

MARKING / BESCHRIFTUNG / MARCATURA / MARQUAGE: **TRANSFER TAPE OR EMBOSSED**



NORMS NORMEN NORME NORMES	ISO 1307	COLOUR FARBEN COLORI COULEUR	
------------------------------------	----------	---------------------------------------	--

Glass Fibre Cover Water

Outside Temp. up to 600 °C



TUBE : BLACK NATURAL AND SYNTHETIC RUBBER.
 REINFORCEMENT : HIGH TENSILE SYNTHETIC TEXTILE.
 COVER : BLACK , HEAT (UP TO 600 °C), WEATHER RESISTANT SYNTHETIC RUBBER AND GLASS FIBER.
 APPLICATION : FOR COOLING WATER TRANSFER IN STEEL MILLS AND FOUNDRIES.



SEELE : SCHWARZES NATUR- UND SYNTHETISCHES KAUTSCHUK.
 EINLAGEN : HOCHZUGFESTE SYNTHETISCHE TEXTILEINLAGE.
 DECKE : SCHWARZES, BIS ZU 600 °C HITZEBESTÄNDIGER, WITTERUNGSBESTÄNDIGES SPEZIELLES SYNTHETISCHES-GUMMI, MIT GLASFASERUMFLECHTUNG.
 ANWENDUNG : KÜHLT INDUSTRIESCHLÄUCHE IN GIEßEREIEN SOWIE STAHLWERKEN.



SOTTOSTRATO : GOMMA NERA NATURALE E SINTETICA.
 RINFORZO : INSERZIONI TESSILI AD ALTA TENACITÀ.
 COPERTURA : GOMMA SPECIALE SINTETICA, E FIBRO DI VETRO RESISTENTE AL CALORE FINO A 600°C ED AGLI AGENTI ATMOSFERICI.
 IMPIEGO : PER IL TRASFERIMENTO DELL'ACQUA DI RAFFREDDAMENTO NELLE ACCIAIERIE E FONDERIE.



TUBE : CAOUTCHOUC NATUREL ET SYNTHETIQUE NOIR.
 REINFORCEMENT : INSERTION TEXTILE HAUTE TENACITE.
 REVETEMENT : CAOUTCHOUC SYNTHETIQUE NOIR, RESISTANT A LA CHALEUR JUSQU'A 600 °C ET AUX AGENTS ATMOSPHERIQUES REVETU DE FIBRE DE VERRE.
 APPLICATION : POUR LE TRANSFERT DES EAUX DE REFROIDISSEMENT DANS LES ACIÉRIES ET LES FONDERIES.

ID		OD	WP		BP		W	L
inch	mm	mm	bar	psi	bar	psi	g/m	m
3/8"	10	20	7	102	21	305	311	61
1/2"	12.7	22	7	102	21	305	358	61
5/8"	16	25	7	102	21	305	438	61
3/4"	19	29	7	102	21	305	515	61
1"	25.4	35	7	102	21	305	637	61
1 1/4"	32	41.5	7	102	21	305	846	61
1 1/2"	38	50	7	102	21	305	969	61
1 3/4"	44.5	55	7	102	21	305	1221	61
2"	50.8	63	7	102	21	305	1404	61
2 1/2"	63.5	76	7	102	21	305	2038	61
3"	76.2	89	7	102	21	305	2536	61
4"	101.6	115	7	102	21	305	3313	61
5"	127	145	7	102	21	305	5158	61

OPTIONS / OPTIONEN / OPZIONI / OPTIONS

Upon Request : Outside temperature up to 1200 °C.
 Auf Anfrage : Außentemperatur von bis zu 1200 °C.
 Su Richiesta : Temperatura esterna fino a 1200 °C.
 Sur Demande : Température extérieure jusqu'à 1200 °C.



-25°C / + 75°C
 -13°F / +158°F

NORMS
 NORMEN
 NORME
 NORMES

ISO 1307

COLOUR
 FARBEN
 COLORI
 COULEUR



Nonflammable-Cooling Hose



TUBE : INSULATING GREY EPDM RUBBER.
 REINFORCEMENT : HIGH TENSILE SYNTHETIC TEXTILE.
 COVER : ABRASION, HEAT, STEAM, OZONE AND WEATHER RESISTANT, SPECIAL SYNTHETIC RUBBER.
 APPLICATION : FOR DISCHARGE OF COOLING WATER IN VERY HIGH AMBIENT TEMPERATURE, IN STEEL MILLS, FOUNDRIES ETC.



SEELE : EPDM-GUMMI, GRAU, ISOLIEREND.
 EINLAGE : HOCHZUGFESTE SYNTHETISCHE TEXTILEINLAGE.
 DECKE : ABRIEBFEST, DAMPF-, OZON- UND WITTERUNGSBESTÄNDIG, SPEZIELL SYNTHETISCHER GUMMI.
 ANWENDUNG : GEEIGNET ALS INDUSTRIESCHLAUCH IN GIEßEREIEN SOWIE STAHLWERKEN MIT HOHEN UMGEBUNGSTEMPERATUREN



SOTTOSTRATO : GOMMA IN EPDM GRIGIO, ISOLANTE.
 RINFORZO : INSERZIONI TESSILI AD ALTA TENACITÀ.
 COPERTURA : GOMMA SPECIALE SINTETICA RESISTENTE AL CALORE, AL VAPORE, ALL'ABRASIONE, ALL'OZONO ED AGLI AGENTI ATMOSFERICI.
 IMPIEGO : PER MANDATA D'ACQUA DI RAFFREDDAMENTO NELLE CONDIZIONI AMBIENTALI A TEMPERATURA MOLTO ALTA, ACCIAIERIE, FONDERIE ETC.



TUBE : CAOUTCHOUC EPDM GRIS, ISOLANT.
 REINFORCEMENT : INSERTION TEXTILE HAUTE TENACITE.
 REVETEMENT : CAOUTCHOUC SYNTHETIQUE SPECIAL, RESISTANT A L'ABRASION, A LA CHALEUR, A LA VAPEUR, A L'OZONE ET AUX AGENTS ATMOSPHERIQUES.
 APPLICATION : REFOULEMENT D'EAU DE REFROIDISSEMENT DANS LES MILIEUX OU LA TEMPERATURE EXTERIEURE EST TRES ELEVEE, COMME LES ACIERIES, FONDERIES ETC.

ID		OD	WP		BP		W	L
inch	mm	mm	bar	psi	bar	psi	g/m	m
3/8"	10	19	10	145	30	435	278	40-46-61
1/2"	12.7	22	10	145	30	435	364	40-46-61
3/4"	19	32	10	145	30	435	697	40-46-61
1"	25.4	38	10	145	30	435	826	40-46-61
1 1/4"	32	47	10	145	30	435	1243	40-46-61
1 1/2"	38	54	10	145	30	435	1531	40-46-61
1 3/4"	44.5	61	10	145	30	435	1833	40-46-61
2"	50.8	69	10	145	30	435	2364	40-46-61
2 1/2"	63.5	80	10	145	30	435	2613	40-46-61
3"	76.2	94	10	145	30	435	3114	40-46-61
4"	101.6	122	10	145	30	435	4718	40-46-61

: $\geq 1 \times 10^9 \Omega/m$



-40°C / +150°C
 -40°F / +300°F

MARKING / BESCHRIFTUNG / MARCATURA / MARQUAGE: **TRANSFER TAPE OR EMBOSSED**

SEL OSTRO NON FLAMMABLE CABLE COOLING HOSE - R>10⁹Ω/m - W.P. 10 Bar (145 PSI)

NORMS NORMEN NORME NORMES	ISO 1307	COLOUR FARBEN COLORI COULEUR	
------------------------------------	----------	---------------------------------------	--

Glass Fibre Cover Cooling Water

Outside Temp. up to 600 °C



TUBE : INSULATING WHITE EPDM RUBBER.
 REINFORCEMENT : HIGH TENSILE SYNTHETIC TEXTILE.
 COVER : HEAT (UP TO 600 °C) RESISTANT INSULATING WHITE EPDM RUBBER AND GLASS FIBRE.
 APPLICATION : FOR DISCHARGE OF COOLING WATER IN VERY HIGH AMBIENT TEMPERATURE, IN STEEL MILLS, FOUNDRIES ETC.



SEELE : EPDM-GUMMI.
 EINLAGE : HOCHZUGFESTE TEXTILEINLAGE.
 DECKE : BIS ZU 600 °C HITZEBESTÄNDIGER EPDM-GUMMI MIT GLASFASERUMFLECHTUNG.
 ANWENDUNG : GEEIGNET ALS INDUSTRIESCHLAUCH IN GIEßBEREICHEN SOWIE STAHLWERKEN MIT HOHEN UMGEBUNGSTEMPERATUREN.



SOTTOSTRATO : GOMMA IN EPDM BIANCA, ISOLANTE.
 RINFORZO : INSERZIONI TESSILI AD ALTA TENACITÀ
 COPERTURA : GOMMA IN EPDM BIANCA ISOLANTE E FIBRA DI VETRO, RESISTENTE AL CALORE FINO A 600°C.
 IMPIEGO : PER MANDATA D'ACQUA DI RAFFREDDAMENTO NELLE CONDIZIONI AMBIENTALI A TEMPERATURA MOLTO ALTA, ACCIAIERIE, FONDERIE ETC.



TUBE : CAOUTCHOUC EPDM BLANC, ISOLANT.
 REINFORCEMENT : INSERTION TEXTILE HAUTE TENACITE..
 REVETEMENT : CAOUTCHOUC EPDM BLANC, ISOLANT ET FIBRE DE VERRE, RESISTANT A LA CHALEUR JUSQU'A 600 °C.
 APPLICATION : REFOULEMENT D'EAU DE REFROIDISSEMENT DANS LES MILIEUX OU LA TEMPERATURE EXTERIEURE EST TRES ELEVEE, COMME LES ACIERIES, FONDERIES ETC.

ID		OD	WP		BP		W	L
inch	mm	mm	bar	psi	bar	psi	g/m	m
1/2"	12.7	22	10	145	30	435	335	40-46-61
5/8"	16	26	10	145	30	435	440	40-46-61
3/4"	19	30	10	145	30	435	570	40-46-61
1"	25.4	37	10	145	30	435	735	40-46-61
1 1/4"	32	45	10	145	30	435	990	40-46-61
1 1/2"	38	52	10	145	30	435	1242	40-46-61
1 3/4"	44.5	59	10	145	30	435	1486	40-46-61
2"	50.8	65	10	145	30	435	1640	40-46-61
2 1/2"	63.5	79	10	145	30	435	2145	40-46-61
3"	76.2	94	10	145	30	435	3015	40-46-61
4"	101.6	120	10	145	30	435	3955	40-46-61

OPTIONS / OPTIONEN / OPZIONI / OPTIONS

Upon Request : Outside temperature up to 1200 °C.
 Auf Anfrage : Außentemperatur von bis zu 1200 °C.
 Su Richiesta : Temperatura esterna fino a 1200 °C.
 Sur Demande : Température extérieure jusqu'à 1200 °C.

: ≥1x 10⁹ Ω/m



-40 °C / +125 °C
 -40 °F / +257 °F

NORMS NORMEN NORME NORMES	ISO 1307	COLOUR FARBEN COLORI COULEUR	
------------------------------------	----------	---------------------------------------	--

2 Glass Fibre Cover Cooling Water

Outside Temp. up to 600 °C



 TUBE : INSULATING EPDM RUBBER.
 REINFORCEMENT : HIGH TENSILE SYNTHETIC TEXTILE.
 COVER : ABRASION, HEAT, OZONE AND WEATHER RESISTANT, INSULATING SPECIAL SYNTHETIC RUBBER AND 2 GLASS FIBRE.
 APPLICATION : FOR COOLING WATER SYSTEMS OF STEEL MILLS AND FOUNDRIES. RESISTANT TO HEAT AND MOLTEN METAL CONTACT. WHERE A HOSE IS WORKING CLOSE TO SOURCES OF HEAT (UP TO 600 °C).

 SEELE : EPDM-GUMMI, ISOLIEREND.
 EINLAGEN : HOCHZUGFESTE TEXTILEINLAGE.
 DECKE : ABRIEB-, WÄRME-, OZON- UND WITTERUNGSBESTÄNDIG SPEZIELLES SYNTHETISCHES-GUMMI, ISOLIEREND MIT 2 GLASFASERUMFLECHTUNGEN.
 ANWENDUNG : KÜHLT UND SCHÜTZT INDUSTRIESCHLÄUCHE IN GIEßEREIEN SOWIE STAHLWERKEN MIT HOHEN UMGEBUNGSTEMPERATUREN, BIS ZU 600 °C BESTÄNDIG.

 SOTTOSTRATO : GOMMA IN EPDM, ISOLANTE.
 RINFORZO : INSERZIONI TESSILI AD ALTA TENACITÀ
 COPERTURA : GOMMA SPECIALE SINTETICA ISOLANTE E 2 FIBRE DI VETRO, RESISTENTE AL CALORE, ALL'ABRASIONE, ALL'OZONO ED AGLI AGENTI ATMOSFERICI.
 IMPIEGO : PER SISTEMI DI ACQUE DI RAFFREDDAMENTO DI ACCIAIERIE E FONDERIE. RESISTENTE AL CALORE E FUSO METALLO. QUANDO IL TUBO LAVORA NELLE VICINANZE DI FONTI DI CALORE (FINO AL 600 °C).

 TUBE : CAOUTCHOUC EPDM, ISOLANT.
 RENFORCEMENT : INSERTION TEXTILE HAUTE TENACITE.
 REVETEMENT : CAOUTCHOUC SYNTHETIQUE SPECIAL ISOLANT REVETU DE 2 FIBRES DE VERRE, RESISTANT A L'ABRASION, A LA CHALEUR, A L'OZONE ET AUX AGENTS ATMOSPHERIQUES.
 APPLICATION : POUR SYSTEMES DE REFROIDISSEMENT DANS LES ACIERIES ET FONDERIES. RESISTANT A LA CHALEUR ET AUX CONTACT DES METAUX EN FUSION. LORSQUE LE TUYAU TRAVAILLE A PROXIMITE DE SOURCES DE CHALEUR (JUSQU'A 600 °C).

ID		OD	WP		BP		W	L
inch	mm	mm	bar	psi	bar	psi	g/m	m
4"	101.6	130	16	232	64	928	6860	20
5"	127	155	16	232	64	928	8360	20
6"	152.4	181	16	232	64	928	9920	20
8"	203	232	16	232	64	928	12725	20
10"	254	282	16	232	64	928	15500	20

OPTIONS / OPTIONEN / OPZIONI / OPTIONS

Upon Request : Outside temperature up to 1200 °C.

Auf Anfrage : Außentemperatur von bis zu 1200 °C.

Su Richiesta : Temperatura esterna fino a 1200 °C.

Sur Demande : Température extérieure jusqu'à 1200 °C.



-40°C / +125°C
 -40°F / +257°F

NORMS NORMEN NORME NORMES	ISO 1307	COLOUR FARBEN COLORI COULEUR	
------------------------------------	----------	---------------------------------------	--

2 Glass Fibre Cover Cooling Water with Built-in Flange

Outside Temp. up to 600 °C



TUBE : INSULATING EPDM RUBBER.
 REINFORCEMENT : HIGH TENSILE SYNTHETIC TEXTILE AND STEEL WIRE HELIX.
 COVER : ABRASION, HEAT, OZONE AND WEATHER RESISTANT, INSULATING SPECIAL SYNTHETIC RUBBER AND 2 GLASS FIBRE.
 APPLICATION : FOR COOLING WATER SYSTEMS OF STEEL MILLS AND FOUNDRIES. RESISTANT TO HEAT AND MOLTEN METAL CONTACT. WHERE A HOSE IS WORKING CLOSE TO SOURCES OF HEAT (UP TO 600 °C).



SEELE : EPDM-GUMMI, ISOLIEREND.
 EINLAGEN : HOCHZUGFESTE, SYNTHETISCHE TEXTILEINLAGEN MIT ZUSÄTZLICHER STAHLDRAHTSPIRALE.
 DECKE : ABRIEB-, WÄRME-, OZON- UND WITTERUNGSBESTÄNDIG SPEZIELLES SYNTHETISCHES-GUMMI, ISOLIEREND MIT 2 GLASFASERUMFLECHTUNGEN.
 ANWENDUNG : KÜHLT UND SCHÜTZT INDUSTRIESCHLÄUCHE IN GIEBEREIEN SOWIE STAHLWERKEN MIT HOHEN UMGEBUNGSTEMPERATUREN, BIS ZU 600 °C BESTÄNDIG.



SOTTOSTRATO : GOMMA IN EPDM, ISOLANTE.
 RINFORZO : INSERZIONI TESSILI AD ALTA TENACITÀ CON SPIRALE METALLICA.
 COPERTURA : GOMMA SPECIALE SINTETICA ISOLANTE E 2 FIBRE DI VETRO, RESISTENTE AL CALORE, ALL'ABRASIONE, ALL'OZONO ED AGLI AGENTI ATMOSFERICI.
 IMPIEGO : PER SISTEMI DI ACQUE DI RAFFREDDAMENTO DI ACCIAIERIE E FONDERIE. RESISTENTE AL CALORE E FUSO METALLO. QUANDO IL TUBO LAVORA NELLE VICINANZE DI FONTI DI CALORE (FINO AL 600 °C).



TUBE : CAOUTCHOUC EPDM, ISOLANT.
 RENFORCEMENT : INSERTION TEXTILE HAUTE TENACITE, SPIRALE EN ACIER NOYEE.
 REVETEMENT : CAOUTCHOUC SYNTHETIQUE SPECIAL ISOLANT REVETU DE 2 FIBRES DE VERRE, RESISTANT A L'ABRASION, A LA CHALEUR, A L'OZONE ET AUX AGENTS ATMOSPHERIQUES.
 APPLICATION : POUR SYSTEMES DE REFROIDISSEMENT DANS LES ACIERIES ET FONDERIES. RESISTANT A LA CHALEUR ET AUX CONTACT DES METAUX EN FUSION. LORSQUE LE TUYAU TRAVAILLE A PROXIMITE DE SOURCES DE CHALEUR (JUSQU'A 600 °C)

ID		OD	WP		BP		W	L
inch	mm	mm	bar	psi	bar	psi	g/m	m
4"	101.6	129	10	145	30	435	8970	20
5"	127	162	10	145	30	435	8970	20
6"	152.4	187	10	145	30	435	10570	20
8"	203	244	10	145	30	435	19160	20
10"	254	294	10	145	30	435	23950	20

OPTIONS / OPTIONEN / OPZIONI / OPTIONS

Upon Request : Outside temperature up to 1200 °C.

Auf Anfrage : Außentemperatur von bis zu 1200 °C.

Su Richiesta : Temperatura esterna fino a 1200 °C.

Sur Demande : Température extérieure jusqu'à 1200 °C.

NOTES ON ORDERING

A - Inside diameter
 B- Length (Overall Length)
 C- Working pressure
 D- Type ends or end fittings
 E- Applications (Much detail as possible)
 F- Working temperature

BEMERKUNGEN ZUM AUFTRAG

A- Innendurchmesser
 B- Schlauchlänge F-F
 C- Betriebsdruck
 D- Flanschbezeichnung
 E- Einsatzbedingungen (Möglichst viele information angeben)
 F- Betriebstemperatur

NOTE ORDINI

A- Diametro interno
 B- Lunghezza (Flange Incluso)
 C- Pressione di lavoro
 D- Specificazioni per le flange
 E- Applicazione (Massimo dettagli possibile)
 F- Temperatura di lavoro

PRECISIONS NECESSAIRES

A- Diametre interieur
 B- Longueur (Brides incluses)
 C- Pression de service
 D- Specificaions des brides
 E- Applications (Plus de details possible)
 F- Temperature de travail



-40 °C / +125 °C
 -40 °F / +257 °F

NORMS
 NORMEN
 NORME
 NORMES

ISO 1307

COLOUR
 FARBEN
 COLORI
 COULEUR



Ceramic Coated Cover Hot Water



TUBE : EPDM RUBBER.
 REINFORCEMENT : HIGH TENSILE SYNTHETIC TEXTILE.
 COVER : HEAT (UP TO 600 °C), ABRASION, OZONE AND WEATHER RESISTANT CERAMIC COATED EPDM RUBBER.
 APPLICATION : FOR TRANSFER OF WATER AND HOT WATER IN INDUSTRY, WHERE A HOSE MUST BE RESISTANT TO HEAT.



SEELE : EPDM-GUMMI.
 EINLAGEN : HOCHZUGFESTE SYNTHETISCHE TEXTILEINLAGE.
 DECKE : ABRIEB-, WÄRME-, OZON- UND WITTERUNGSBESTÄNDIG EPDM-GUMMI MIT KERAMIKUMMANTELUNG, BIS ZU 600 °C BESTÄNDIG.
 ANWENDUNG : GEEIGNET ZUR FÖRDERUNG VON WASSER UND HEIßWASSER IN INDUSTRIEN MIT HOHEN UMGEBUNGSTEMPERATUREN.



SOTTOSTRATO : GOMMA IN EPDM
 RINFORZO : INSERZIONI TESSILI AD ALTA TENACITÀ
 COPERTURA : GOMMA IN EPDM E RIVESTIMENTO CERAMICO, RESISTENTE AL CALORE FINO A 600°C, ALL'ABRASIONE, ALL'OZONO ED AGLI AGENTI ATMOSFERICI.
 IMPIEGO : PER IL TRASFERIMENTO DI ACQUA E ACQUA CALDA NELL'INDUSTRIA, DOVE UN TUBO DEVE ESSERE RESISTENTE AL CALORE.



TUBE : CAOUTCHOUC EPDM.
 RENFORCEMENT : INSERTION TEXTILE HAUTE TENACITE.
 REVETEMENT : CAOUTCHOUC EPDM ET REVÊTEMENT CÉRAMIQUE, RESISTANT A LA CHALEUR JUSQU'A 600 °C, A L'ABRASION, A L'OZONE ET AUX AGENTS ATMOSPHERIQUES.
 APPLICATION : POUR LE TRANSFERT DE L'EAU ET EAU DE REFROIDISSEMENT DES PORTES DE HAUTE-FOURNEAUX.

ID		OD	WP		BP		W	L
inch	mm	mm	bar	psi	bar	psi	g/m	m
1/2"	12.7	24	25	363	100	1450	420	40-46-61
3/4"	19	30	25	363	100	1450	570	40-46-61
1"	25.4	38	25	363	100	1450	830	40-46-61
1 1/4"	32	46	25	363	100	1450	1135	40-46-61
1 1/2"	38	52	25	363	100	1450	1320	40-46-61
1 3/4"	44.5	60	25	363	100	1450	1745	40-46-61
2"	50.8	67	25	363	100	1450	2250	40-46-61
2 1/2"	63.5	81	25	363	100	1450	2525	40-46-61
3"	76.2	95	25	363	100	1450	3250	40-46-61
4"	101.6	123	25	363	100	1450	5300	40-46-61



-40°C / +125°C
 -40°F / +257°F

NORMS
 NORMEN
 NORME
 NORMES

ISO 1307

COLOUR
 FARBEN
 COLORI
 COULEUR



Glass Fibre Cover Steam

Outside Temp. up to 600 °C



 TUBE : EPM RUBBER, RESISTANT TO SATURATED STEAM.
 REINFORCEMENT : HIGH TENSILE SYNTHETIC TEXTILE.
 COVER : ABRASION, HEAT, STEAM, OZONE AND WEATHER RESISTANT, SPECIAL SYNTHETIC RUBBER AND GLASS FIBRE.
 APPLICATION : FOR GENERAL SATURATED STEAM SERVICES AT A MAXIMUM WORKING PRESSURE OF 7 BAR (102 PSI) WHERE A HOSE IS WORKING CLOSE TO SOURCES OF HEAT (UP TO 600 °C).

 SEELE : EPM-GUMMI, SATTDAMPFBESTÄNDIG.
 EINLAGEN : HOCHZUGFESTE SYNTHETISCHE TEXTILEINLAGE.
 DECKE : ABRIB-, DAMPF-, WÄRME-, OZON- UND WITTERUNGSBESTÄNDIG SPEZIELLES SYNTHETISCHES-GUMMI, ISOLIEREND MIT GLASFASERUMFLECHTUNG.
 ANWENDUNG : FÜR ANWENDUNGEN MIT SATTDAMPF MIT EINEM MAXIMALEN BETRIEBSDRUCK VON 7 BAR (102 PSI), BIS ZU 600 °C BESTÄNDIG.

 SOTTOSTRATO : GOMMA EPM, RESISTENTE AL VAPORE SATURO.
 RINFORZO : INSERZIONI TESSILI AD ALTA TENACITÀ.
 COPERTURA : GOMMA SPECIALE SINTETICA E FIBRA DI VETRO, RESISTENTE AL CALORE, AL VAPORE, ALL'ABRASIONE, ALL'OZONO ED AGLI AGENTI ATMOSFERICI.
 IMPIEGO : PASSAGGIO DI VAPORE SATURO PER USO INDUSTRIALE GENERALE AD UNA PRESSIONE MASSIMA DI ESERCIZIO DI 7 BAR (102 PSI) QUANDO IL TUBO LAVORA NELLE VICINANZE DI FONTI DI CALORE (FINO AL 600 °C).

 TUBE : CAOUTCHOUC EPM, RESISTANT A LA VAPEUR SATUREE.
 RENFORCEMENT : INSERTION TEXTILE HAUTE TENACITE.
 REVETEMENT : CAOUTCHOUC SYNTHETIQUE REVETU DE FIBRE DE VERRE, RESISTANT A L'ABRASION, A LA CHALEUR, A LA VAPEUR, A L'OZONE ET AUX AGENTS ATMOSPHERIQUES.
 APPLICATION : POUR SERVICES GENERAUX DE VAPEUR SATUREE A UNE PRESSION MAXIMALE DE 7 BAR (102 PSI) LORSQUE LE TUYAU TRAVAILLE A PROXIMITE DE SOURCES DE CHALEUR (JUSQU'A 600 °C)

ID		OD	WP		BP		W	L
inch	mm	mm	bar	psi	bar	psi	g/m	m
1/2"	12.7	24	7	102	70	1015	410	40-46-61
5/8"	16	30	7	102	70	1015	650	40-46-61
3/4"	19	33	7	102	70	1015	710	40-46-61
1"	25.4	39.5	7	102	70	1015	820	40-46-61
1 1/4"	32	47	7	102	70	1015	1145	40-46-61
1 1/2"	38	53	7	102	70	1015	1345	40-46-61
1 3/4"	44.5	60	7	102	70	1015	1570	40-46-61
2"	50.8	67.5	7	102	70	1015	1970	40-46-61
2 1/2"	63.5	81	7	102	70	1015	2510	40-46-61
3"	76.2	98	7	102	70	1015	3660	40-46-61
4"	101.6	124	7	102	70	1015	4830	40-46-61



NORMS NORMEN NORME NORMES	ISO 1307	COLOUR FARBEN COLORI COULEUR	
------------------------------------	----------	---------------------------------------	---

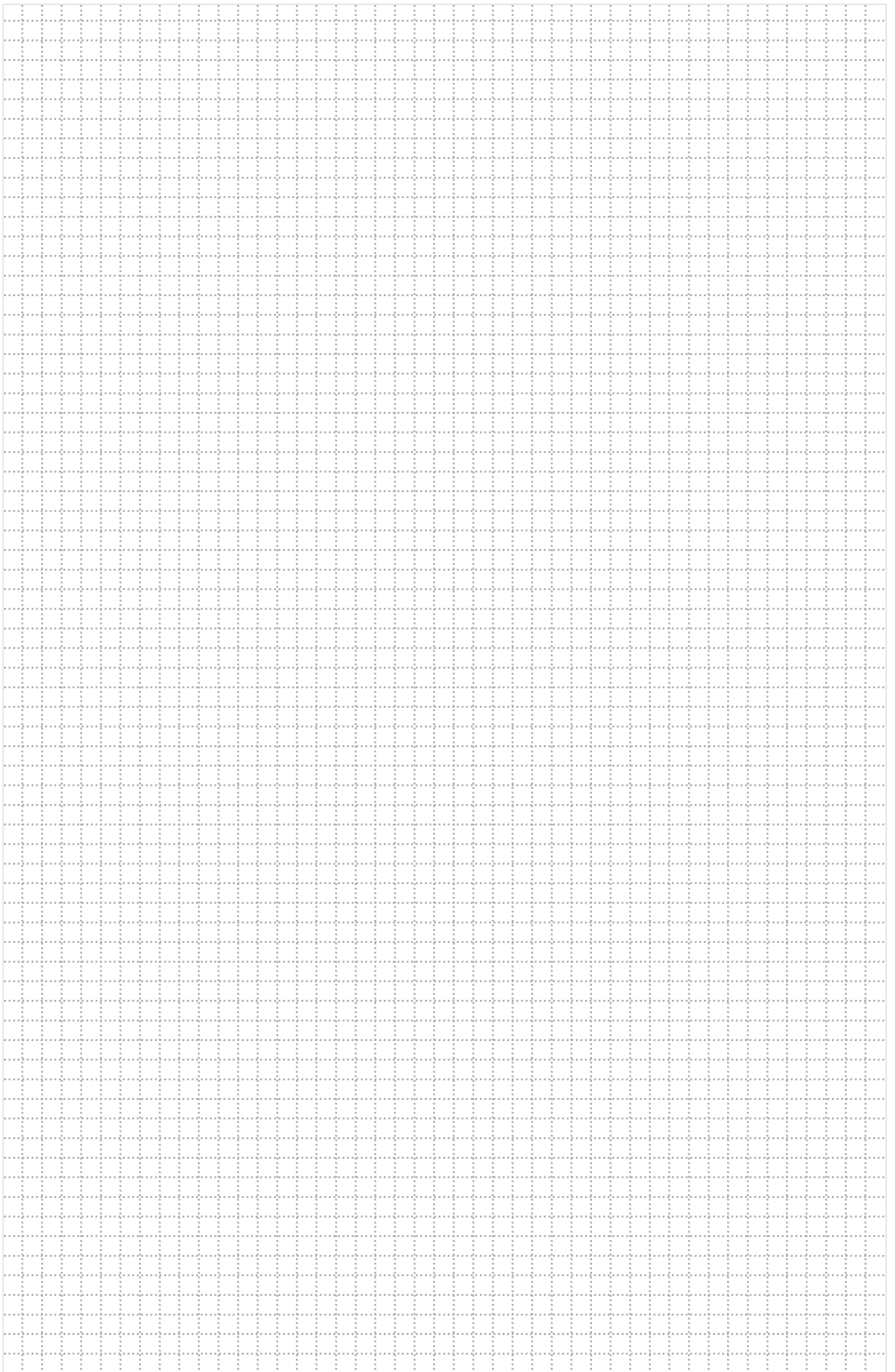

Silicone

Silikon

Silicone

Silicone



Silicone Cooling

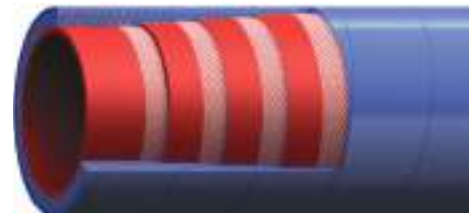

TUBE : SEA WATER, WATER MIXED WITH ANTI-FREEZE, MINERAL OILS RESISTANT SMOOTH SILICONE.
 REINFORCEMENT : HIGH TENSILE SYNTHETIC TEXTILE.
 COVER : SEA WATER, ABRASION, OZONE, WEATHER AND FLAME RESISTANT SMOOTH SILICONE..
 APPLICATION : FOR DELIVERY OF VERY HIGH TEMPERATURE EXHAUST GASES AND SEA WATER IN COOLING SYSTEMS OF MARINE VEHICLES, WHERE HIGH PERFORMANCE AND EXTRA FLEXIBILITY ARE REQUIRED.



SEELE : SILIKON, BESTÄNDIG GEGEN MEERWASSER, WASSER - FROSTSCHUTZMITTELGEMISCH UND MINERALÖLE.
 EINLAGE : HOCHZUGFESTE SYNTHETISCHE TEXTILEINLAGE.
 DECKE : SILIKON, MEERWASSER-, OZON- UND WITTERUNGSBESTÄNDIG, ABRIEBFEST, FLAMMWIDRIG.
 ANWENDUNG : ZUM BEFÖRDERN VON ABGASEN MIT HOHEN TEMPERATUREN UND MEERWASSER IN KÜHLSYSTEMEN VON SCHIFFEN, HOHE LEISTUNG - EXTRA FLEXIBILITÄT.



SOTTOSTRATO : SILICONE, RESISTENTE ALL'ACQUA DI MARE, ACQUA CON ANTIGELO, AGLI OLI MINERALI.
 RINFORZO : INSERZIONI TESSILI AD ALTA TENACITÀ.
 COPERTURA : SILICONE LISCIA, RESISTENTE ALL'ACQUA DI MARE, ALL'OZONO, ALL'ABRASIONE, AGLI AGENTI ATMOSFERICI ED ALLA FIAMMA.
 IMPIEGO : PER IL COLLEGAMENTO EXTRA FLESSIBILE NEI CIRCUITI DI RAFFREDDAMENTO DEI MOTORI NAUTICI, AD ALTISSIMA TEMPERATURA.



TUBE : SILICONE, RESISTANT A L'EAU DE MER, ANTIGEL, AUX HUILES MINERALES.
 RENFORCEMENT : INSERTION TEXTILE HAUTE TENACITE.
 REVETEMENT : SILICONE LISSE, RESISTANT A L'EAU DE MER, A L'ABRASION, A L'OZONE, AUX AGENTS ATMOSPHERIQUES, A LA FLAMME.
 APPLICATION : POUR LES SYSTEMES DE REFRROIDISSEMENT DES MOTEURS MARINS AVEC UNE TEMPERATURE TRES ELEVEE.

ID		OD	WP		BP		W	L
inch	mm	mm	bar	psi	bar	psi	g/m	m
3/4"	19	27	5	73	15	218	335	40
1"	25.4	34	5	73	15	218	455	40
1 1/4"	32	40	5	73	15	218	550	40
1 1/2"	38	46	5	73	15	218	650	40
1 3/4"	44.5	53	5	73	15	218	740	40
2"	50.8	59	5	73	15	218	840	40
2 1/2"	63.5	73	5	73	15	218	1030	18.3
3"	76.2	85	5	73	15	218	1320	18.3
3 1/2"	90	99	5	73	15	218	1582	18.3
4"	101.6	112	5	73	15	218	1970	18.3



-54°C / +177°C
 -65°F / +350°F

MARKING / BESCHRIFTUNG / MARCATURA / MARQUAGE: **TRANSFER TAPE**

SEL SIROCCO SILICONE COOLING HOSE - W.P. 5 Bar (73 PSI) - ISO 13363 Type 1 - Class B

NORMS NORMEN NORME NORMES	ISO 13363 TYPE 1 - CLASS B SAE J 2006 R1	COLOUR FARBEN COLORI COULEUR	
------------------------------------	---	---------------------------------------	--

Silicone Cooling S&D



TUBE : SEA WATER, WATER MIXED WITH ANTI-FREEZE, MINERAL OILS RESISTANT SMOOTH SILICONE.
 REINFORCEMENT : HIGH TENSILE SYNTHETIC TEXTILE AND STEEL HELIX WIRE.
 COVER : SEA WATER, ABRASION, OZONE, WEATHER AND FLAME RESISTANT SILICONE.
 APPLICATION : FOR SUCTION AND DELIVERY OF VERY HIGH TEMPERATURE EXHAUST GASES AND SEA WATER IN COOLING SYSTEMS OF MARINE VEHICLES, WHERE HIGH PERFORMANCE AND EXTRA FLEXIBILITY ARE REQUIRED.



SEELE : SILIKON, BESTÄNDIG GEGEN MEERWASSER, WASSER - FROSTSCHUTZMITTELGEMISCH UND MINERALÖLE
 EINLAGE : HOCHZUGFESTE SYNTHETISCHE TEXTILEINLAGE MIT EINER STAHLDRAHTSPIRALE
 DECKE : SILIKON, MEERWASSER-, OZON- UND WITTERUNGSBESTÄNDIG, ABRIEBFEST, FLAMMWIDRIG
 ANWENDUNG : SAUG - DRUCKSCHLAUCH FÜR ABGASE MIT HOHEN TEMPERATUREN UND MEERWASSER IN KÜHLSYSTEMEN VON SCHIFFEN, HOHE LEISTUNG - EXTRA FLEXIBILITÄT



SOTTOSTRATO : SILICONE, RESISTENTE ALL'ACQUA DI MARE, ACQUA CON ANTIGELO, AGLI OLI MINERALI.
 RINFORZO : INSERZIONI TESSILI AD ALTA TENACITÀ CON SPIRALE D'ACCIAIO INCORPORATA.
 COPERTURA : SILICONE, RESISTENTE ALL'ACQUA DI MARE, ALL'OZONO, ALL'ABRASIONE, AGLI AGENTI ATMOSFERICI ED ALLA FIAMMA.
 IMPIEGO : PER IL COLLEGAMENTO EXTRA FLESSIBILE NEI CIRCUITI DI RAFFREDDAMENTO DEI MOTORI NAUTICI, AD ALTISSIMA TEMPERATURA.



TUBE : SILICONE, RESISTANT A L'EAU DE MER, ANTIGEL, AUX HUILES MINERALES.
 RENFORCEMENT : INSERTION TEXTILE HAUTE TENACITE ET SPIRALE EN ACIER NOYEE.
 REVETEMENT : SILICONE, RESISTANT A L'EAU DE MER, A L'ABRASION, A L'OZONO, AUX AGENTS ATMOSPHERIQUES ET A LA FLAMME.
 APPLICATION : POUR LES SYSTEMES DE REFROIDISSEMENT DES MOTEURS MARINS AVEC UNE TEMPERATURE TRES ELEVEE.

ID		OD	WP		BP		VACUUM	BR/r	W	L
inch	mm	mm	bar	psi	bar	psi	bar	mm	g/m	m
1/2"	12.7	23	15	218	45	653	-0.8	20	397	40
3/4"	19	30	15	218	45	653	-0.8	35	557	40
1"	25.4	36	10	145	30	435	-0.8	50	713	40
1 1/4"	32	43	10	145	30	435	-0.8	75	887	40
1 1/2"	38	50	10	145	30	435	-0.8	92	1179	40
1 3/4"	44.5	56	5	73	15	218	-0.8	100	1354	40
2"	50.8	62.5	5	73	15	218	-0.8	125	1590	40
2 1/2"	63.5	75	5	73	15	218	-0.8	160	1946	18.3
3"	76.2	89.5	5	73	15	218	-0.8	200	2661	18.3
3 1/2"	90	103	5	73	15	218	-0.8	300	3105	18.3
4"	101.6	117	5	73	15	218	-0.8	400	3883	18.3



-54°C / +177°C
 -65°F / +350°F

MARKING / BESCHRIFTUNG / MARCATURA / MARQUAGE: **TRANSFER TAPE**

SEL SIROCCO - SD SILICONE COOLING S/D HOSE - W.P. 5 Bar (73 PSI) - ISO 13363 Type 2 -Class B

NORMS NORMEN NORME NORMES	ISO 13363 TYPE 2 - CLASS B SAE J 2006 R2	COLOUR FARBEN COLORI COULEUR	
------------------------------------	---	---------------------------------------	--

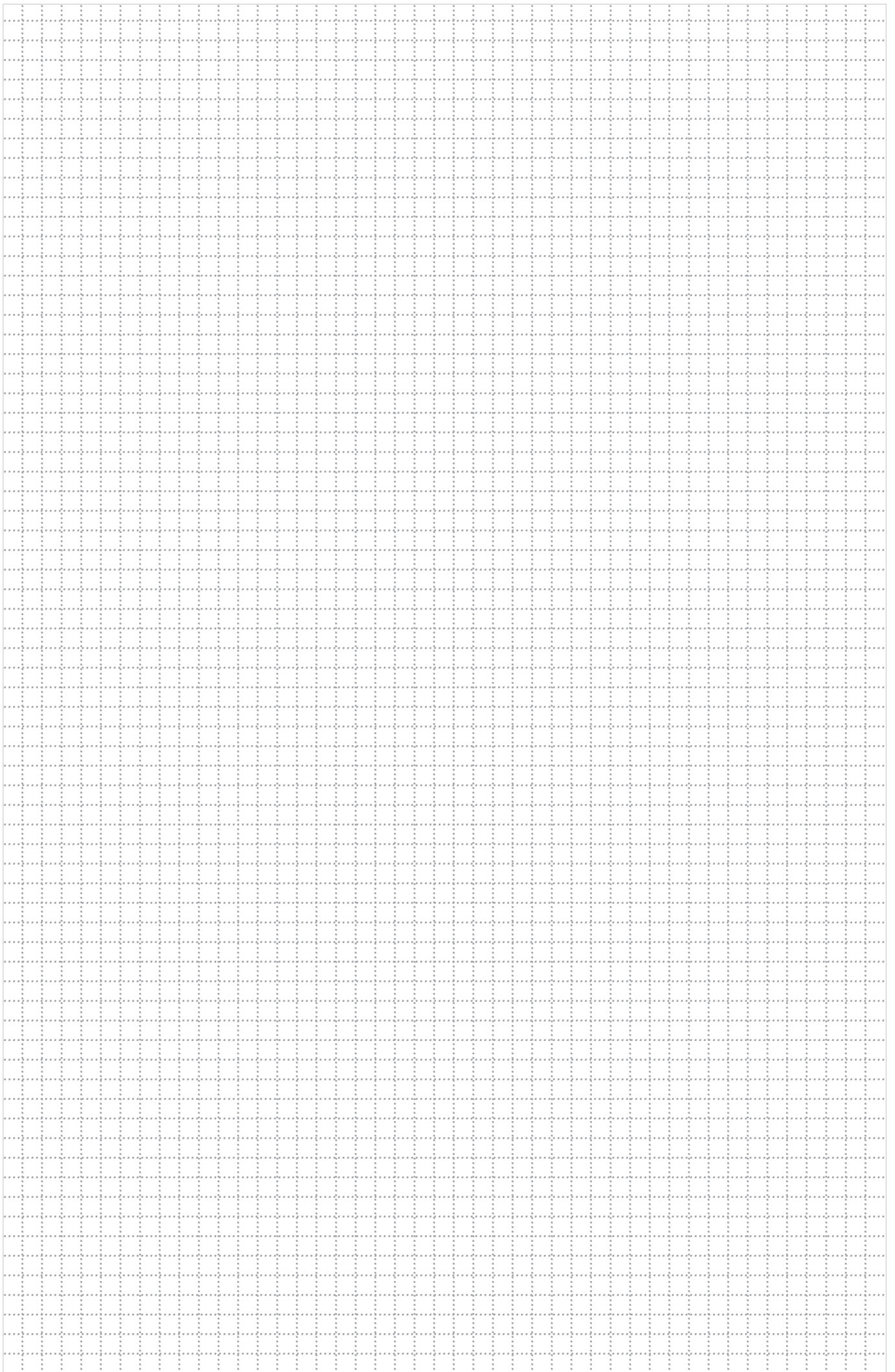

Offshore

- Oil Rigs Platform
- Ölplattform
- Piattaforme Petrolifere
- Plateformes Pétrolières

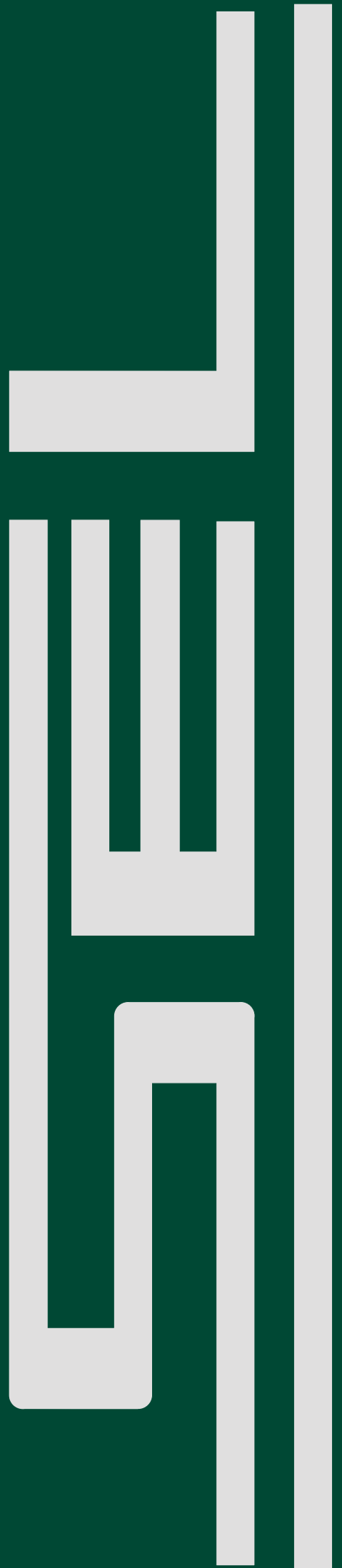

Soft Wall Oil / Fuel Delivery



TUBE : BLACK, FUEL AND OIL RESISTANT NBR.
 REINFORCEMENT : HIGH TENSILE SYNTHETIC TEXTILE AND ANTISTATIC COPPER WIRE.
 COVER : OIL, FUEL, SEA WATER, FLAME, WEATHER AND OZONE RESISTANT BLACK CR.
 APPLICATION : FOR DISCHARGE OF HEAVY DUTY PETROLEUM PRODUCTS UP TO 50% AROMATIC CONTENT.



SEELE : ÖL-UND KRAFTSTOFFBESTÄNDIG, NITRILGUMMI, SCHWARZ.
 EINLAGE : HOCHZUGSFESTE SYNTHETISCHE TEXTILEINLAGE MIT ANTISTATISCHE KUPFERLITZE.
 DECKE : ÖL-, OZON-, MEER- UND WITTERUNGBESTÄNDIGER, SPEZIELLER SYNTHETIKGUMMI, ABRIEFEST, FLAMMWIDRIG
 ANWENDUNG : FÖRDERSCHLAUCH FÜR VERSCHIEDENE ÖLPRODUKTE MIT MAX. 50% AROMATENGHALT



SOTTOSTRATO : GOMMA NBR NERA, RESISTENTE AI PRODOTTI PETROLIFERI.
 RINFORZO : INSERZIONE TESSILI AD ALTA TENACITÀ E CORDICELLA DI RAME ANTISTATICA.
 COPERTURA : GOMMA CR NERA RESISTENTE AGLI OLI, AI CARBURANTI, ALL'ACQUA DI MARE, ALLA FIAMMA, ALL'OZONO ET AGLI AGENTI ATMOSFERICI.
 IMPIEGO : PER MANDATA DI PRODOTTI PETROLIFERI CON CENTENUTO AROMATICO FINO AL 50%.



TUBE : CAOUTCHOUC NBR, NOIR, RESISTANT AUX HUILES ET HYDROCARBURES.
 RENFORCEMENT : INSERTION TEXTILE HAUTE TENACITE ET FIL DE MASSE ANTISTATIQUE.
 REVETEMENT : CAOUTCHOUC CR, RESISTANT AUX HUILES, AUX HYDROCARBURES, A L'EAU DE MER, A LA FLAMME, A L'OZONE ET AUX AGENTS ATMOSPHERIQUES.
 APPLICATION : POUR REFOULEMENT D'HYDROCARBURES A TENEUR EN AROMATIQUES JUSQU'A 50%

ID		OD		WP		BP		BR/r	W	L
inch	mm	mm	mm	bar	psi	bar	psi	mm	g/m	m
3	76	93		10	145	40	580	760	3057	max. 61
4	102	118		10	145	40	580	1020	3995	max. 61
5	127	144		7	102	28	406	1270	5048	max. 61
6	152	169		7	102	28	406	1520	5696	max. 61



-35°C / + 80°C
 -31°F / +176°F

MARKING / BESCHRIFTUNG / MARCATURA / MARQUAGE: **TRANSFER TAPE OR EMBOSSED**

SEL OSRIS - FD RS 225 OIL DISCHARGE W.P. ** BAR - (month/year)

NORMS NORMEN NORME NORMES	ISO 1307	COLOUR FARBEN COLORI COULEUR	
------------------------------------	----------	---------------------------------------	--

Soft Wall Water Delivery

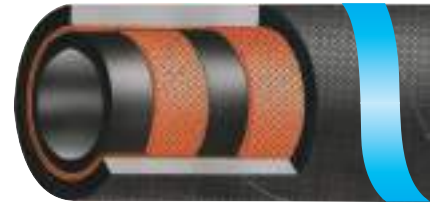

TUBE : BLACK, SPECIAL SYNTHETIC RUBBER.
 REINFORCEMENT : HIGH TENSILE SYNTHETIC TEXTILE.
 COVER : OIL, FUEL, SEA WATER, WEATHER AND OZONE RESISTANT BLACK CR.
 APPLICATION : FOR DISCHARGE OF WATER.



SEELE : SCHWARZ, SPEZIELLER SYNTHETISCHER GUMMI
 EINLAGE : HOCHZUGSFESTE SYNTHETISCHE TEXTILEINLAGE
 DECKE : ÖL-, OZON-, MEER- UND WITTERUNGBESTÄNDIGER, SCHWARZER CR
 ANWENDUNG : FÖRDERSCHLAUCH FÜR WASSER



SOTTOSTRATO : GOMMA NBR NERA.
 RINFORZO : INSERZIONE TESSILI AD ALTA TENACITÀ.
 COPERTURA : GOMMA CR NERA RESISTENTE AGLI OLI, AI CARBURANTI, ALL'ACQUA DI MARE, ALL'OZONO ET AGLI AGENTI ATMOSFERICI.
 IMPIEGO : PER MANDATA D'ACQUA.



TUBE : CAOUTCHOUC NBR, NOIR.
 RENFORCEMENT : INSERTION TEXTILE HAUTE TENACITE.
 REVETEMENT : CAOUTCHOUC CR, RESISTANT AUX HUILES, AUX HYDROCARBURES, A L'EAU DE MER, A L'OZONO ET AUX AGENTS ATMOSPHERIQUES.
 APPLICATION : POUR REFOULEMENT D'EAU.

ID		OD		WP		BP		BR/r	W	L
inch	mm	mm	mm	bar	psi	bar	psi	mm	g/m	m
3	76	93		10	145	40	580	760	3057	max. 61
4	102	118		10	145	40	580	1020	3995	max. 61
5	127	144		7	102	28	406	1270	5048	max. 61
6	152	169		7	102	28	406	1520	5696	max. 61



-35°C / + 80°C
 -31°F / +176°F

MARKING / BESCHRIFTUNG / MARCATURA / MARQUAGE: **TRANSFER TAPE OR EMBOSSED**

SEL OSRIS - WD RS 115 WATER DISCHARGE W.P. ** BAR - (month/year)

NORMS NORMEN NORME NORMES	ISO 1307	COLOUR FARBEN COLORI COULEUR	
------------------------------------	----------	---------------------------------------	--

Hard Wall Oil / Fuel Suction & Delivery



TUBE : BLACK, FUEL AND OIL RESISTANT NBR.
 REINFORCEMENT : HIGH TENSILE SYNTHETIC TEXTILE WITH 2 STEEL WIRE HELIX AND ANTISTATIC COPPER WIRE.
 COVER : OIL, FUEL, WEATHER AND OZONE RESISTANT BLACK CR.
 APPLICATION : FOR SUCTION AND DISCHARGE OF HEAVY DUTY PETROLEUM PRODUCTS UP TO 50% AROMATIC CONTENT.



SEELE : ÖL-UND KRAFTSTOFFBESTÄNDIG, NITRILGUMMI, SCHWARZ.
 EINLAGE : HOCHZUGSFESTE SYNTHETISCHE TEXTILEINLAGE, MIT 2 STAHLDRAHTSPIRALEN UND ANTISTATISCHER KUPFERLITZE.
 DECKE : ÖL-, OZON-, MEER- UND WITTERUNGBESTÄNDIGER, SPEZIELLER SYNTHETIKGUMMI, ABRIEBFEST, FLAMMWIDRIG
 ANWENDUNG : SAUG- UND DRUCKSCHLAUCH FÜR VERSCHIEDENE ÖLPRODUKTE MIT MAX. 50% AROMATENGHEALT



SOTTOSTRATO : GOMMA NBR NERA, RESISTENTE AI PRODOTTI PETROLIFERI.
 RINFORZO : INSERZIONE TESSILI AD ALTA TENACITÀ, 2 SPIRALE D'ACCIAIO E CORDICELLA DI RAME ANTISTATICA.
 COPERTURA : GOMMA CR NERA RESISTENTE AGLI OLI, AI CARBURANTI, ALL'ACQUA DI MARE, ALLA FIAMMA, ALL'OZONO ET AGLI AGENTI ATMOSFERICI.
 IMPIEGO : PER ASPIRAZIONE E MANDATA DI PRODOTTI PETROLIFERI CON CENTENUTO AROMATICO FINO AL 50%.



TUBE : CAOUTCHOUC NBR, NOIR, RESISTANT AUX HUILES ET HYDROCARBURES.
 RENFORCEMENT : INSERTION TEXTILE HAUTE TENACITE, 2 SPIRALES EN ACIER ET FIL DE MASSE ANTISTATIQUE.
 REVETEMENT : CAOUTCHOUC CR, RESISTANT AUX HUILES, AUX HYDROCARBURES, A L'EAU DE MER, A LA FLAMME, A L'OZONE ET AUX AGENTS ATMOSPHERIQUES.
 APPLICATION : POUR ASPIRATION ET REFOULEMENT D'HYDROCARBURES A TENEUR EN AROMATIQUES JUSQU'A 50%

ID		OD		WP		BP		VACUUM	BR/r	W	L
inch	mm	mm	bar	psi	bar	psi	bar	mm	g/m	m	
3	76	93,5	16	232	64	928	-0.80	608	3625	max. 61	
4	102	118,5	16	232	64	928	-0.80	816	4804	max. 61	
5	127	149	10	145	40	580	-0.80	1000	7588	max. 61	
6	152	174	10	145	40	580	-0.80	1216	9364	max. 61	
8	203	230	10	145	40	580	-0.80	1624	15390	max. 20	



-35°C / + 80°C
 -31°F / +176°F

MARKING / BESCHRIFTUNG / MARCATURA / MARQUAGE: **TRANSFER TAPE OR EMBOSSED**

SEL OSRIS - FSD RS 455 OIL FUEL S/D W.P. ** BAR - (month/year)

NORMS NORMEN NORME NORMES	ISO 1307	COLOUR FARBEN COLORI COULEUR	
------------------------------------	----------	---------------------------------------	--

Soft Wall Bulk Material Delivery



TUBE : HIGH ABRASION RESISTANT ANTISTATIC NR (ABRASION VALUE 70 MM3 DIN 53516)
 REINFORCEMENT : HIGH TENSILE SYNTHETIC TEXTILE AND ANTISTATIC COPPER WIRE.
 COVER : SEA WATER, WEATHER AND OZONE RESISTANT BLACK, EPDM RUBBER.
 APPLICATION : FOR DISCHARGE BARITE, BENTONITE AND OTHER ABRASIVE MATERIALS.



SEELE : HOCH ABRIEBFEST, LEITFÄHIG, NATURGUMMI.
 EINLAGE : HOCHZUGFESTE SYNTHETISCHE TEXTILEINLAGE UND ANTISTATISCHE KUPFERLITZE.
 DECKE : OZON-, MEERWASSER- UND WITTERUNGSBESTÄNDIGER EPDM GUMMI, SCHWARZ
 ANWENDUNG : ZUR BEFÖRDERUNG VON BARYT-, BETON- UND ANDEREN ABRASIVEN OBERFLÄCHEN



SOTTOSTRATO : GOMMA NR ANTISTATICA, RESISTENTE ALL'ABRASIONE.
 RINFORZO : INSERZIONI TESSILI AD ALTA TENACITÀ E CORDICELLA DI RAME ANTISTATICA.
 COPERTURA : GOMMA EPDM, RESISTENTE ALL'ACQUA DI MARE, ALL'OZONO ED AGLI AGENTI ATMOSFERICI.
 IMPIEGO : PER MANDATA DI BARITE, BENTONITE ED ALTRI MATERIALI ABRASIVI.



TUBE : CAOUTCHOUC NR CONDUCTEUR, RESISTANT A L'ABRASION.
 RENFORCEMENT : INSERTION TEXTILE HAUTE TENACITE ET FIL DE MASSE ANTISTATIQUE.
 REVETEMENT : CAOUTCHOUC EPDM, RESISTANT A L'EAU DE MER, A L'OZONE ET AUX AGENTS ATMOSPHERIQUES.
 APPLICATION : POUR REFOULEMENT DE BARYTE, BENTONITE ET AUTRES MATERIAUX ABRASIFS.

ID		OD	WP		BP		BR/r	W	L
inch	mm	mm	bar	psi	bar	psi	mm	g/m	m
3	76	97	14	203	56	812	760	3240	max. 61
4	102	123	10	145	40	580	1020	4500	max. 61
5	127	149	10	145	40	580	1270	5817	max. 61
6	152	174	10	145	40	580	1520	6634	max. 61



-40°C / + 70°C
 -40°F / +158°F

MARKING / BESCHRIFTUNG / MARCATURA / MARQUAGE: **TRANSFER TAPE OR EMBOSSED**

SEL OSRIS - MD RS 715 BULK MATERIAL DISCHARGE W.P. ** BAR - (month/year)

NORMS NORMEN NORME NORMES	ISO 1307	COLOUR FARBEN COLORI COULEUR	
------------------------------------	----------	---------------------------------------	--



Hard Wall Bulk Material Suction & Delivery

 TUBE : HIGH ABRASION RESISTANT ANTISTATIC NR (ABRASION VALUE 70 MM3 DIN 53516)
 REINFORCEMENT : HIGH TENSILE SYNTHETIC TEXTILE, 2 STEEL WIRE HELIX AND ANTISTATIC COPPER WIRE
 COVER : SEA WATER, WEATHER AND OZONE RESISTANT BLACK, EPDM RUBBER.
 APPLICATION : FOR SUCTION AND DISCHARGE BARITE, BENTONITE AND OTHER ABRASIVE MATERIALS.

 SEELE : HOCH ABRIEBFEST, LEITFÄHIG, NATURGUMMI.
 EINLAGE : HOCHZUGFESTE SYNTHETISCHE TEXTILEINLAGE, MIT 2 STAHLDRAHTSPIRALEN UND ANTISTATISCHER KUPFERLITZE.
 DECKE : OZON-, MEERWASSER- UND WITTERUNGSBESTÄNDIGER EPDM GUMMI, SCHWARZ
 ANWENDUNG : SAUG- UND DRUCKSCHLAUCH FÜR BARYT-, BETON UND ANDEREN ABRASIVEN OBERFLÄCHEN

 SOTTOSTRATO : GOMMA NR ANTISTATICA, RESISTENTE ALL'ABRASIONE.
 RINFORZO : INSERZIONI TESSILI AD ALTA TENACITÀ, 2 SPIRALE D'ACCIAIO E CORDICELLA DI RAME ANTISTATICA.
 COPERTURA : GOMMA EPDM, RESISTENTE ALL'ACQUA DI MARE, ALL'OZONO ED AGLI AGENTI ATMOSFERICI.
 IMPIEGO : PER ASPIRAZIONE E MANDATA DI BARITE, BENTONITE ED ALTRI MATERIALI ABRASIVI.



 TUBE : CAOUTCHOUC NR CONDUCTEUR, RESISTANT A L'ABRASION.
 RENFORCEMENT : INSERTION TEXTILE HAUTE TENACITE, 2 SPIRALES EN ACIER ET FIL DE MASSE ANTISTATIQUE.
 REVETEMENT : CAOUTCHOUC EPDM, RESISTANT A L'EAU DE MER, A L'OZONE ET AUX AGENTS ATMOSFERIQUES.
 APPLICATION : POUR ASPIRATION ET REFOULEMENT DE BARYTE, BENTONITE ET AUTRES MATERIAUX ABRASIFS.

ID		OD	WP		BP		VACUUM	BR/r	W	L
inch	mm	mm	bar	psi	bar	psi	bar	mm	g/m	m
4	102	123	10	145	40	580	-0.80	1020	5370	max. 61
5	127	149	10	145	40	580	-0.80	1270	6969	max. 61
6	152	174	10	145	40	580	-0.80	1520	8707	max. 61



-40°C / + 70°C
 -40°F / +158°F

MARKING / BESCHRIFTUNG / MARCATURA / MARQUAGE: **TRANSFER TAPE OR EMBOSSED**

 **OSRIS - MSD RS 725 BULK MATERIAL S/D W.P. ** BAR - (month/year)** 

NORMS NORMEN NORME NORMES	ISO 1307	COLOUR FARBEN COLORI COULEUR	
------------------------------------	----------	---------------------------------------	--

Soft Wall Liquid Mud Delivery



TUBE : BLACK, SPECIAL SYNTHETIC RUBBER
 REINFORCEMENT : HIGH TENSILE SYNTHETIC TEXTILE AND ANTISTATIC COPPER WIRE.
 COVER : SEA WATER, WEATHER AND OZONE RESISTANT BLACK CR.
 APPLICATION : FOR DISCHARGE OF HIGH PRESSURE LIQUID MUD, MINERAL OILS ETC.



SEELE : SCHWARZ, SPEZIELL SYNTHETISCHER GUMMI
 EINLAGE : HOCHZUGFESTE SYNTHETISCHE TEXTILEINLAGE UND ANTISTATISCHE KUPFERLITZE.
 DECKE : OZON-, MEERWASSER- UND WITTERUNGSBESTÄNDIGER CR, SCHWARZ
 ANWENDUNG : ZUR BEFÖRDERUNG VON MINERALÖLEN UND SCHLAMM USW.



SOTTOSTRATO : GOMMA SPECIALE SINTETICA, NERA.
 RINFORZO : INSERZIONI TESSILI AD ALTA TENACITÀ E CORDICELLA DI RAME ANTISTATICA.
 COPERTURA : GOMMA CR, RESISTENTE ALL'ACQUA DI MARE, ALL'OZONO ED AGLI AGENTI ATMOSFERICI.
 IMPIEGO : PER MANDATA DI FANGHI DI PERFORAZIONE, OLI MINERALI ETC.



TUBE : CAOUTCHOUC SPECIAL SYNTHETIQUE, NOIR.
 RENFORCEMENT : INSERTION TEXTILE HAUTE TENACITE ET FIL DE MASSE ANTISTATIQUE.
 REVETEMENT : CAOUTCHOUC CR, RESISTANT A L'EAU DE MER, A L'OZONE ET AUX AGENTS ATMOSPHERIQUES.
 APPLICATION : POUR REFOULEMENT DE BOUES DE FORAGE, D'HUILES MINERALES, SOUS FORTE PRESSION.

ID		OD		WP		BP		BR/r	W	L
inch	mm	mm	mm	bar	psi	bar	psi	mm	g/m	m
3	76	97		40	580	165	2393	760	3732	max. 61
4	102	126		40	580	165	2393	1020	5689	max. 61



-35°C / + 80°C
 -31°F / +176°F

MARKING / BESCHRIFTUNG / MARCATURA / MARQUAGE: **TRANSFER TAPE OR EMBOSSED**

SEL OSRIS - LMD RS 735 LIQUID MUD DISCHARGE W.P. ** BAR - (month/year)

NORMS NORMEN NORME NORMES	ISO 1307	COLOUR FARBEN COLORI COULEUR	
------------------------------------	----------	---------------------------------------	--

Hard Wall Liquid Mud Suction & Delivery



TUBE : BLACK, SPECIAL SYNTHETIC RUBBER
 REINFORCEMENT : HIGH TENSILE SYNTHETIC TEXTILE, 2 STEEL WIRE HELIX AND ANTISTATIC COPPER WIRE.
 COVER : SEA WATER, WEATHER AND OZONE RESISTANT BLACK CR.
 APPLICATION : FOR SUCTION AND DISCHARGE OF HIGH PRESSURE LIQUID MUD, MINERAL OILS ETC.



SEELE : SCHWARZ, SPEZIELL SYNTHETISCHER GUMMI
 EINLAGE : HOCHZUGFESTE SYNTHETISCHE TEXTILEINLAGE, MIT 2 STAHLDRAHTSPIRALEN UND ANTISTATISCHER KUPFERLITZE.
 DECKE : OZON-, MEERWASSER- UND WITTERUNGSBESTÄNDIGER CR, SCHWARZ
 ANWENDUNG : SAUG- UND DRUCKSCHLAUCH FÜR MINERALÖLE UND SCHLAMM USW.



SOTTOSTRATO : GOMMA SPECIALE SINTETICA, NERA.
 RINFORZO : INSERZIONI TESSILI AD ALTA TENACITÀ, 2 SPIRALE D'ACCIAIO E CORDICELLA DI RAME ANTISTATICA.
 COPERTURA : GOMMA CR, RESISTENTE ALL'ACQUA DI MARE, ALL'OZONO ED AGLI AGENTI ATMOSFERICI.
 IMPIEGO : PER ASPIRAZIONE E MANDATA DI FANGHI DI PERFORAZIONE, OLI MINERALI ETC.



TUBE : CAOUTCHOUC SPECIAL SYNTHETIQUE, NOIR.
 RENFORCEMENT : INSERTION TEXTILE HAUTE TENACITE, 2 SPIRALES EN ACIER ET FIL DE MASSE ANTISTATIQUE.
 REVETEMENT : CAOUTCHOUC CR, RESISTANT A L'EAU DE MER, A L'OZONE ET AUX AGENTS ATMOSPHERIQUES.
 APPLICATION : POUR ASPIRATION ET REFOULEMENT DE BOUES DE FORAGE, D'HUILES MINERALES, SOUS FORTE PRESSION.

ID		OD		WP		BP		VACUUM	BR/r	W	L
inch	mm	mm	mm	bar	psi	bar	psi	bar	mm	g/m	m
4	102	127	40	580	165	2393	-0.80	1020	6905	max. 61	
5	127	153	40	580	165	2393	-0.80	1270	9700	max. 61	



-35°C / + 80°C
 -31°F / +176°F

MARKING / BESCHRIFTUNG / MARCATURA / MARQUAGE: **TRANSFER TAPE OR EMBOSSED**

SEL OSRIS - LMSD RS 745 LIQUID MUD S/D W.P. ** BAR - (month/year)

NORMS NORMEN NORME NORMES	ISO 1307	COLOUR FARBEN COLORI COULEUR	
------------------------------------	----------	---------------------------------------	--

Soft Wall Potable Water Delivery (F.D.A.)

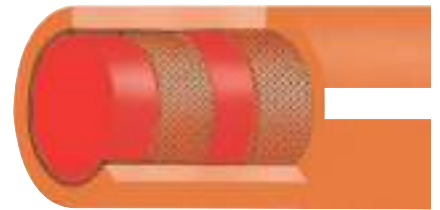

TUBE : RED NON-TOXIC, FOOD QUALITY, TASTE AND ODOUR FREE, NR.
 REINFORCEMENT : HIGH TENSILE SYNTHETIC TEXTILE
 COVER : SEA WATER, WEATHER AND OZONE RESISTANT ORANGE, EPDM RUBBER.
 APPLICATION : FOR DISCHARGE OF POTABLE WATER.



SEELE : GESCHMACKS- UND GERUCHSNEUTRAL , LEBENSMITTELECHT, SPEZIELLER NBR GUMMI, ROT, SCHADSTOFFFREI
 EINLAGE : HOCHZUGFESTE SYNTHETISCHE TEXTILEINLAGE.
 DECKE : OZON- MEERWASSER UND WITTERUNGSBESTÄNDIGER, ABRIEBSFESTER, EPDM GUMMI, ORANGE.
 ANWENDUNG : ZUM DURCHLEITEN VON TRINKWASSER.



SOTTOSTRATO : NR ROSSO ATOSSICA, DI QUALITÀ ALIMENTARE INSAPORE ED INODORE.
 RINFORZO : INSERZIONI TESSILI AD ALTA TENACITÀ.
 COPERTURA : GOMMA EPDM, RESISTENTE ALL'ACQUA DI MARE, ALL'OZONO ED AGLI AGENTI ATMOSFERICI.
 IMPIEGO : PER MANDATA DI ACQUA POTABILE.



TUBE : NR ROUGE, NON TOXIQUE, QUALITE ALIMENTAIRE, ANTI ODEUR ET NE TRANSMETTANT PAS DE GOUT.
 RENFORCEMENT : INSERTION TEXTILE HAUTE TENACITE.
 REVETEMENT : CAOUTCHOUC EPDM, RESISTANT A L'EAU DE MER, A L'OZONE ET AUX AGENTS ATMOSPHERIQUES.
 APPLICATION : POUR REFOULEMENT D'EAU POTABLE.

ID		OD		WP		BP		BR/r	W	L
inch	mm	mm	mm	bar	psi	bar	psi	mm	g/m	m
3	76	93		10	145	40	580	760	3239	max. 61
4	102	118.5		10	145	40	580	1020	4019	max. 61
5	127	146		8	115	32	460	1270	5250	max. 61
6	152	169		8	115	32	460	1520	5830	max. 61



-30°C / + 70°C
 -22°F / +158°F

MARKING / BESCHRIFTUNG / MARCATURA / MARQUAGE: **TRANSFER TAPE OR EMBOSSED**

SEL OSRIS - PW RS 835 POTABLE WATER DISCHARGE W.P. ** BAR - (month/year)

NORMS NORMEN NORME NORMES	ISO 1307 MEETS FDA AND EUROPEAN REQUIREMENTS	COLOUR FARBEN COLORI COULEUR	
------------------------------------	---	---------------------------------------	--

Hard Wall Potable Water Suction & Delivery (F.D.A.)



TUBE : RED NON-TOXIC, FOOD QUALITY, TASTE AND ODOUR FREE, NR.
 REINFORCEMENT : HIGH TENSILE SYNTHETIC TEXTILE AND STEEL WIRE HELIX.
 COVER : SEA WATER, WEATHER AND OZONE RESISTANT ORANGE, EPDM RUBBER.
 APPLICATION : FOR SUCTION AND DISCHARGE OF POTABLE WATER.



SEELE : GESCHMACKS- UND GERUCHSNEUTRAL, LEBENSMITTELECHT, SPEZIELLER NBR GUMMI, ROT, SCHADSTOFFFREI
 EINLAGE : HOCHZUGFESTE SYNTHETISCHE TEXTILEINLAGE MIT EINER STAHLDRAHTSPIRALE
 DECKE : OZON-, MEERWASSER UND WITTERUNGSBESTÄNDIGER, ABRIEBSFESTER, EPDM GUMMI, ORANGE.
 ANWENDUNG : FÜR TRINKWASSER GEEIGNETER SAUG- UND DRUCKSCHLAUCH.



SOTTOSTRATO : NR ROSSO ATOSSICA, DI QUALITÀ ALIMENTARE INSAPORE ED INODORE.
 RINFORZO : INSERZIONI TESSILI AD ALTA TENACITÀ E SPIRALE D'ACCIAIO.
 COPERTURA : GOMMA EPDM, RESISTENTE ALL'ACQUA DI MARE, ALL'OZONO ED AGLI AGENTI ATMOSFERICI.
 IMPIEGO : PER ASPIRAZIONE E MANDATA DI ACQUA POTABILE.



TUBE : NR ROUGE, NON TOXIQUE, QUALITE ALIMENTAIRE, ANTI ODEUR ET NE TRANSMETTANT PAS DE GOUT.
 RENFORCEMENT : INSERTION TEXTILE HAUTE TENACITE ET SPIRALE EN ACIER.
 REVETEMENT : CAOUTCHOUC EPDM, RESISTANT A L'EAU DE MER, A L'OZONE ET AUX AGENTS ATMOSPHERIQUES.
 APPLICATION : POUR ASPIRATION ET REFOULEMENT D'EAU POTABLE.

ID		OD	WP		BP		VACUUM	BR/r	W	L
inch	mm	mm	bar	psi	bar	psi	bar	mm	g/m	m
3	76	97	16	232	64	928	-0.80	608	4368	max. 61
4	102	119	16	232	64	928	-0.80	816	4566	max. 61



-30°C / + 70°C
 -22°F / +158°F

MARKING / BESCHRIFTUNG / MARCATURA / MARQUAGE: **TRANSFER TAPE OR EMBOSSED**

SEL OSRIS - PWSD RS 845 POTABLE WATER S/D W.P. ** BAR - (month/year)

NORMS NORMEN NORME NORMES	ISO 1307 MEETS FDA AND EUROPEAN REQUIREMENTS	COLOUR FARBEN COLORI COULEUR	
------------------------------------	---	---------------------------------------	--



Hard Wall Chemical Suction & Delivery

XLPE



TUBE : CHEMICALS, SOLVENTS, PETROLEUM PRODUCTS & OIL RESISTANT TRANSLUCENT XLPE.
 REINFORCEMENT : HIGH TENSILE SYNTHETIC TEXTILE, 2 STEEL WIRE HELIX AND 2 ANTISTATIC COPPER WIRES.
 COVER : SEA WATER, WEATHER, OZONE, ABRASION AND FLAME RESISTANT GREEN, EPDM RUBBER.
 APPLICATION : FOR SUCTION AND DISCHARGE WIDE RANGE OF CHEMICALS, PETROLEUM PRODUCTS, OILS, SOLVENTS, ALCOHOL ETC. (SEE SEL CHEMICAL RESISTANCE CHART).



SEELE : GEGEN CHEMIKALIEN, LÖSUNGSMITTEL, ERDÖLPRODUKTE UND ÖLE BESTÄNDIGER, TRANSPARENTE XLPE - BESCHICHTUNG
 EINLAGE : HOCHZUGFESTE SYNTHETISCHE TEXTILEINLAGE MIT 2 STAHLDRAHTSPIRALEN UND 2 ANTISTATISCHEN KUPFERLITZEN
 DECKE : OZON-, MEERWASSER UND WITTERUNGSBESTÄNDIGER, ABRIEBSFESTER, FLAMMWIDRIGER EPDM GUMMI
 ANWENDUNG : SAUG - DRUCKSCHLAUCH GEEIGNET FÜR VIELE CHEMIKALIEN; ERDÖLPRODUKTE, ÖLE, HOCHAROMATISCHE LÖSUNGSMITTEL, ALKOHOL USW. (SIEHE SEL BESTÄNDIGKEITSLISTE)



SOTTOSTRATO : XLPE TRANSPARENTE RESISTENTE AI SOLVENTI, PRODOTTI CHIMICI, PETROLIFERI E OLII.
 RINFORZO : INSERZIONI TESSILI AD ALTA TENACITÀ, 2 SPIRALE D'ACCIAIO, 2 CORDICELLA DI RAME.
 COPERTURA : GOMMA IN EPDM, VERDE, RESISTENTE ALL'ACQUA DI MARE, ALL'ABRASIONE, ALL'OZONO, ALLA FIAMMA ED AGLI AGENTI ATMOSFERICI.
 IMPIEGO : PER ASPIRAZIONE E MANDATA DEI PRODOTTI CHIMICI, PETROLIFERI, ALCOLICI, SOLVENTI SPECIALI ED OLII. (VEDERE LA TABELLA SEL DI RESISTENZA CHIMICA).



TUBE : XLPE TRANSLUCIDE RESISTANT AUX SOLVENTS, PRODUITS CHIMIQUES, PETROLIERS E HUILES.
 RENFORCEMENT : INSERTION TEXTILE HAUTE TENACITE, 2 SPIRALES EN ACIER ET 2 FILS DE CUIVRE.
 REVETEMENT : CAOUTCHOUC EPDM, VERT, RESISTANT A L'ABRASION, A L'OZONE, A LA FLAMME ET AUX AGENTS ATMOSPHERIQUES.
 APPLICATION : POUR ASPIRATION ET REFOULEMENT DES PRODUITS CHIMIQUES, PETROLIERS, SOLVENTS, ALCOOL E HUILES ETC. ETC. (VOIR LE TABLEAU DE RESISTANCE CHIMIQUE SEL)

ID		OD		WP		BP		VACUUM	BR/r	W	L
inch	mm	mm	mm	bar	psi	bar	psi	bar	mm	g/m	m
3	76	91	102	10	145	40	580	-0.80	530	3150	max. 61
4	102	120	138	10	145	40	580	-0.80	700	4680	max. 61



-30°C / + 70°C
 -22°F / +158°F

MARKING / BESCHRIFTUNG / MARCATURA / MARQUAGE: **TRANSFER TAPE OR EMBOSSED**

SEL OSRIS - CHSD RS 685 CHEMICAL S/D W.P. ** BAR - (month/year)

NORMS NORMEN NORME NORMES	ISO 1307	COLOUR FARBEN COLORI COULEUR	
------------------------------------	----------	---------------------------------------	--

Hard Wall Chemical Suction & Delivery



UHMW-PE



TUBE : TRANSLUCENT, FOOD GRADE UHMW-PE LINER SUITABLE FOR WIDE RANGE OF CORROSIVE CHEMICALS AND SOLVENTS.
 REINFORCEMENT : HIGH TENSILE SYNTHETIC TEXTILE, 2 STEEL WIRE HELIX AND ANTISTATIC COPPER WIRE.
 COVER : SEA WATER, WEATHER, OZONE, ABRASION RESISTANT BLUE, EPDM RUBBER.
 APPLICATION : FOR SUCTION AND DISCHARGE OF ALL CORROSIVE CHEMICALS, SOLVENTS (SEE SEL CHEMICAL RESISTANCE CHART).



SEELE : GEGEN KORROSIVE CHEMIKALIEN UND LÖSUNGSMITTEL BESTÄNDIGER, TRANSPARENTER, LEBENSMITTELECHTER UHMW-PE INLINER
 EINLAGE : HOCHZUGFESTE SYNTHETISCHE TEXTILEINLAGE MIT 2 STAHLDRAHTSPIRALE UND ANTISTATISCHE KUPFERLITZE
 DECKE : OZON-, MEERWASSER UND WITTERUNGSBESTÄNDIGER, ABRIEBSFESTER EPDM GUMMI, BLAU
 ANWENDUNG : SAUG - DRUCKSCHLAUCH GEEIGNET FÜR ALLE KORROSIVE CHEMIKALIEN, HOCHAROMATISCHE LÖSUNGSMITTEL (SIEHE SEL BESTÄNDIGKEITSLISTE)



SOTTOSTRATO : UHMW-PE - TRANSPARENTE, DI QUALITÀ ALIMENTARE, RESISTENTE AI PRODOTTI CHIMICI ALTAMENTE CORROSIVI E SOLVENTI.
 RINFORZO : INSERZIONI TESSILI AD ALTA TENACITÀ, 2 SPIRALES D'ACCIAIO E CORDICELLA DI RAME.
 COPERTURA : GOMMA IN EPDM, BLU RESISTENTE, ALL'ACQUA DI MARE, ALL'ABRASIONE, ALL'OZONO ED AGLI AGENTI ATMOSFERICI.
 IMPIEGO : PER ASPIRAZIONE E MANDATA DI PRODOTTI CHIMICI CORROSIVI, SOLVENTI ETC. (VEDERE LA TABELLA SEL DI RESISTENZA CHIMICA).



TUBE : UHMW-PE TRANSLUCIDE, DE QUALITÉ ALIMENTAIRE, RESISTANT AUX PRODUITS CHIMIQUES CORROSIFS.
 RENFORCEMENT : INSERTION TEXTILE HAUTE TENACITÉ, SPIRALE EN ACIER ET FIL DE CUIVRE.
 REVETEMENT : CAOUTCHOUC EPDM, BLEU, RESISTANT A L'EAU DE MER, A L'ABRASION, A L'OZONE ET AUX AGENTS ATMOSPHERIQUES.
 APPLICATION : POUR ASPIRATION ET REFOULEMENT DE TOUS LES PRODUITS CHIMIQUE CORROSIFS, LES SOLVENTS. (VOIR LE TABLEAU DE RESISTANCE CHIMIQUE SEL)

ID		OD		WP		BP		VACUUM	BR/r	W	L
inch	mm	mm	mm	bar	psi	bar	psi	bar	mm	g/m	m
3	76	92	16	232	64	928	-0.80	530	3200	max. 61	
4	102	121	16	232	64	928	-0.80	700	4750	max. 61	



-30°C / + 70°C
 -22°F / +158°F

MARKING / BESCHRIFTUNG / MARCATURA / MARQUAGE: **TRANSFER TAPE OR EMBOSSED**



OSRIS - PE RS 610 UHMWPE CHEMICAL S/D W.P. ** BAR - (month/year)



NORMS
 NORMEN
 NORME
 NORMES

ISO 1307

COLOUR
 FARBEN
 COLORI
 COULEUR



An Eaton Brand

Info

Info

Info

Info

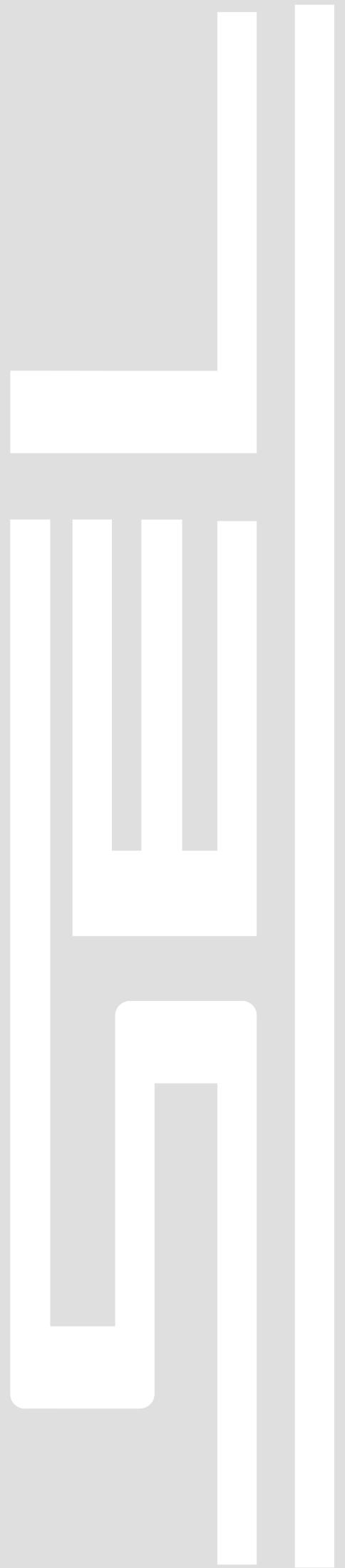

Conversion Chart

	Unit	From	To	Multiply By
Length	1 Inch	in	m	0.0254
	1 Meter	m	in	39.370
	1 Foot	ft	m	0.3048
	1 Meter	m	ft	3.281
Area	1 Square inch	in ²	mm ²	645.16
	1 Square meter	m ²	in ²	1550
Volume	1 Gallon (UK)	gal	L	4.546
	1 Liter	L	gal (UK)	0.22
	1 Gallon (US)	gal	L	3.78
	1 Liter	L	gal (US)	0.264
Weight	1 Pound	1 lb	kg	0.454
	1 Kilogram	kg	1 lb	2.205
Pressure	1 Pound per square inch	psi	bar	0.06895
	1 Bar	bar	psi	14.5
	1 Pound per square inch	psi	Mpa	0.006895
	1 Mega Pascal	Mpa	psi	145.035
	1 Kilo Pascal	Kpa	bar	0.01
	1 Bar	bar	Kpa	100
	1 Mega Pascal	Mpa	bar	10
	1 Bar	bar	Mpa	0.1
Velocity	1 Foot per second	ft/s	m/s	0.3048
	1 Meter per second	m/s	ft/s	3.281
Flow Rate	1 Gallon per minute (UK)	gal / min.	l / min.	4.546
	1 Liter per minute	l / min.	gal / min. (UK)	0.22
	1 Gallon per minute (US)	gal / min.	l / min.	3.78
	1 Liter per minute	l / min.	gal / min. (US)	0.264
Temperature	Fahrenheit degree	°F	°C	5/9 (°F-32)
	Celcius degree	°C	°F	9x°C/5+32

Pressure Conversion Table

PSI	MPa	Kgf/cm ²	BARS	ATMOSPHERES	PSI	MPa	Kgf/cm ²	BARS	ATMOSPHERES	PSI	MPa	Kgf/cm ²	BARS	ATMOSPHERES	PSI	MPa	Kgf/cm ²	BARS	ATMOSPHERES
25	.17	1.76	1.72	1.70	2500	17.24	175.77	172.50	170.00	5200	35.85	365.60	353.80	353.60	7900	54.47	555.42	545.10	537.20
50	.34	3.52	3.45	3.40	2600	17.93	182.80	179.40	176.80	5300	36.54	372.63	365.70	360.40	8000	55.16	562.46	552.00	544.00
75	.52	5.27	5.18	5.10	2700	18.62	189.83	186.30	183.60	5400	37.23	379.66	376.60	367.20	8100	55.85	565.49	558.90	550.80
100	.69	7.03	6.90	6.80	2800	19.30	196.86	193.20	190.40	5500	37.92	386.69	379.50	374.00	8200	56.54	576.52	565.80	557.60
200	1.38	14.06	13.80	13.60	2900	19.99	203.89	200.10	197.20	5600	38.61	393.72	386.40	380.80	8300	57.23	583.55	572.70	564.40
300	2.07	21.09	20.70	20.40	3000	20.68	210.92	207.00	204.00	5700	39.30	400.75	393.30	387.60	8400	57.92	590.58	576.60	571.20
400	2.76	28.12	27.60	27.20	3100	21.37	217.95	213.90	210.80	5800	39.99	407.78	400.20	394.40	8500	58.61	597.61	586.50	587.00
500	3.45	65.15	34.50	34.00	3200	22.06	244.98	220.80	217.60	5900	40.68	414.81	407.10	401.20	8600	59.30	604.64	593.40	584.80
600	4.14	42.18	41.40	40.80	3300	22.75	232.01	227.70	224.40	6000	41.37	421.84	414.00	408.00	8700	59.98	611.67	600.30	591.60
700	4.38	49.21	48.30	47.60	3400	23.44	239.04	243.60	231.20	6100	42.06	428.87	420.90	414.80	8800	60.67	618.70	607.20	598.40
800	5.52	56.24	55.20	54.10	3500	24.13	246.07	241.50	238.00	6200	42.75	435.90	427.80	421.60	8900	61.36	625.73	614.10	605.20
900	5.20	63.28	62.10	61.20	3600	24.82	253.10	243.40	244.80	6300	43.44	442.93	434.70	428.40	9000	62.05	632.76	621.00	612.00
1000	6.90	70.31	69.00	68.00	3700	25.51	260.14	255.30	251.60	6400	44.13	449.96	441.60	435.20	9100	62.74	639.79	627.90	618.80
1100	7.58	77.34	75.90	74.80	3800	26.20	267.17	262.20	258.40	6500	44.82	457.00	448.50	442.00	9200	63.43	646.82	634.80	625.60
1200	8.27	84.37	82.80	81.60	3900	26.89	274.20	269.10	265.20	6600	45.51	464.03	455.40	448.80	9300	64.12	653.86	641.70	632.40
1300	8.96	91.40	89.70	88.40	4000	27.58	281.23	276.00	272.00	6700	46.20	471.06	462.30	445.60	9400	64.81	660.89	648.60	639.20
1400	9.65	98.43	96.60	95.20	4100	28.27	288.26	282.90	278.80	6800	46.88	478.09	469.20	462.40	9500	65.50	667.92	655.50	646.00
1500	10.34	105.46	103.50	102.00	4200	28.96	295.29	289.80	285.60	6900	47.57	485.12	476.10	469.20	9600	66.19	674.95	662.40	652.80
1600	11.03	112.49	110.40	108.80	4300	29.65	302.32	296.70	292.40	7000	48.26	492.15	483.00	476.40	9700	66.88	681.98	669.30	659.60
1700	11.72	119.52	117.30	115.60	4400	30.34	309.35	303.60	299.20	7100	48.95	499.18	489.90	469.20	9800	67.57	689.01	676.20	666.40
1800	12.41	126.55	124.20	122.40	4500	31.03	316.38	310.50	306.00	7200	49.64	506.21	496.80	489.60	9900	68.26	696.04	683.10	673.20
1900	13.10	133.58	131.10	129.20	4600	31.72	323.41	317.40	312.80	7300	50.33	513.24	503.70	496.40	10000	68.95	703.07	690.00	680.00
2000	13.79	140.61	138.00	136.00	4700	32.41	330.44	324.30	319.60	7400	51.02	520.27	510.60	503.20	11000	75.84	773.38	759.00	748.00
2100	14.48	147.64	144.90	142.80	4800	33.10	337.47	331.20	326.40	7500	51.71	527.50	517.50	510.00	12000	82.74	843.68	828.00	816.00
2200	15.17	154.68	151.80	149.60	4900	33.78	344.50	338.10	333.20	7600	52.40	534.33	524.40	516.80	13000	89.63	913.99	897.00	884.00
2300	15.86	161.71	158.70	156.40	5000	34.47	351.54	345.00	340.00	7700	53.09	541.36	531.30	523.60	14000	96.53	984.30	966.00	952.00
2400	16.55	168.74	165.60	163.20	5100	35.16	358.57	351.90	346.80	7800	53.78	548.39	538.20	530.40	15000	103.42	1054.60	1035.00	1020.00

PSI X .0068948 = Megapascals (MPa) = meganewton/meter²

PSI X .070307 = Kilogram-force per square centimeter

PSI X .0690 = Bars

PSI X .0680 = Atmospheres

1 MP = 10 Bars

1 Bar = 14.5 PSI

1kgf/cm² = 14.22 PSI

1 PSI = .00689 MPa

Vacuum Conversion Table

ATM	PSI	WATER		MERCURY		%
		METER	FEET	MM	INCHES	
0.1	1.4	1	3' 3-3/8"	73.6	2.9	10
0.2	2.8	2	6' 6-3/4"	147.1	5.8	20
0.3	4.2	3	9' 10-1/8"	220.7	8.7	30
0.4	5.7	4	13' 1-1/2"	249.2	11.6	40
0.5	7.1	5	16' 4-13/16"	267.8	14.5	50
0.6	8.5	6	19' 8-3/16"	441.3	17.4	60
0.7	10.0	7	22' 11-9/16"	514.9	20.3	70
0.8	11.4	8	26' 2-15/16"	588.4	23.2	80
0.9	12.8	9	29' 6-3/8"	662.0	26.0	90
1.0	14.2	10	32' 9-11/16"	735.5	29.0	100

CHEMICAL RESISTANCE CHART

CHEMISCHE BESTÄNDIGKEITSLISTE

TABELLA RESISTENZA CHIMICA

TABLEAU DE REZISTANCE CHIMIQUE



E	EXCELLENT
G	GOOD
F	FAIR
C	ACCEPTABLE
X	UNSATISFACTORY
-	NO DATA



E	SEHR GUT
G	GUT
F	MITTEL
C	AKZEPTABEL
X	NICHT BESTÄNDIG
-	KEIN WERT



E	PERFETTO
G	BUONO
F	MEDIA
C	ACCETTABILE
X	CATTIVO
-	SENZA DATA



E	EXCELLENT
G	BONNE
F	JUSTE
C	ACCEPTABLE
X	NE CONVIENTPAS
-	AUCUNE DONNEE

	NR	SBR CBR	CR	NBR	IIR	CSM	EPDM EPM	XLPE	UHMWPE
ACETALDEHYDE	F	F	F	X	E	C	E	E	E
ACETIC ACID, 10 %	X	C	C	X	E	F	E	E	E
ACETIC ACID, 50 %	X	C	X	X	E	X	E	E	E
ACETIC ANHYDRIDE	X	C	G	X	G	E	E	E	E
ACETONE	C	C	X	X	E	F	E	E	E
ACETYLENE	G	G	G	E	E	G	E	E	E
ACRYLIC ACID	-	-	-	-	-	-	-	-	G
ADIPIC ACID	G	G	G	G	E	-	E	E	E
AIR, +300 F	X	X	X	X	F	X	G	-	-
ALUM	E	E	E	E	E	E	E	E	E
ALUMINUM CHLORIDE	E	E	E	E	E	E	E	E	E
ALUMINUM HYDROXIDE	E	-	E	G	-	G	-	-	E
AMINO BENZENE	X	X	X	X	E	F	E	E	G
AMINODIMETHYLBENZENE	X	X	X	X	X	X	G	G	G
AMMONIUM CHLORIDE	E	E	E	E	E	E	E	E	E
AMMONIUM HYDROXIDE	X	X	E	X	E	G	E	E	E
ANIMAL FATS	X	X	C	E	G	F	G	E	E
ARGON	E	E	E	E	E	C	E	E	E
ARSENIC ACID	G	E	E	E	E	E	E	E	E
ASPHALT	X	X	F	F	F	E	X	F	F
ASTM FUEL A	X	X	E	E	X	F	X	E	E
ASTM FUEL B	X	X	F	E	X	E	X	E	E
ASTM FUEL C	X	X	X	G	X	F	X	-	-
ASTM OIL NO.1	X	X	E	E	X	X	X	E	E
ASTM OIL NO.2	X	X	G	E	X	G	X	E	E
ASTM OIL NO.3	X	X	X	E	X	F	X	E	E
ASTM OIL NO.4	X	X	X	G	X	X	X	-	-
AUTOMATIC TRANSMISSION FLUID	X	X	G	E	X	X	X	-	-
BARIUM CHLORIDE	E	E	E	E	E	C	E	E	E
BARIUM HYDROXIDE	E	E	E	E	E	E	E	E	E
BEER	E	E	E	E	E	E	E	E	E
BENZALDEHYDE	X	X	X	X	E	E	E	E	E
BENZENE	X	X	X	X	X	G	X	F	F
BENZINE	X	X	G	E	X	X	X	G	G
BENZOIC ACID	X	X	F	X	X	C	F	E	E
BENZYL ALCOHOL	X	X	C	X	G	X	G	E	E
BLEACH	X	X	X	X	G	F	G	G	F
BORAX SOLUTION	G	G	E	C	E	X	E	G	-
BORIC ACID	E	E	E	E	E	E	E	E	E
BRAKE FLUID (HD-557) 12 DAYS	-	E	G	C	G	E	E	-	-

	NR	SBR CBR	CR	NBR	IIR	CSM	EPDM EPM	XLPE	UHMWPE
BROMOBENZENE	X	X	X	X	X	X	X	C	G
BUNKER OIL	X	X	X	E	X	X	X	G	G
BUTADIENE	X	X	X	X	X	C	C	G	G
BUTANE	X	X	E	E	X	G	X	-	-
BUTYL ALCOHOL	E	E	E	E	G	G	E	E	E
BUTYLENE	X	X	C	G	X	X	X	-	F
BUTYRIC ACID	-	-	-	-	-	-	C	E	E
CALCIUM BICHROMATE	-	-	-	-	E	F	-	G	F
CALCIUM CHLORIDE	E	E	E	E	E	E	E	E	E
CALCIUM HYDROXIDE	E	E	E	E	E	E	E	E	E
CALCIUM HYPOCHLORITE	E	E	E	E	E	E	E	E	E
CARBON DIOXIDE	G	G	G	E	G	G	G	G	G
CARBON MONOXIDE	G	G	G	E	E	G	E	G	G
CARBONIC ACID	E	C	E	C	E	E	G	E	E
CAUSTIC SODA (SEE SOD. HYD.)	G	G	G	F	G	G	G	G	E
CHLORINATED SOLVENTS	X	X	X	X	X	X	X	G	G
CHLOROBENZENE	X	X	X	X	X	X	X	G	G
CHLOROFORM	X	X	X	X	X	X	X	G	G
CHROME PLATING SOLUTIONS	X	X	X	X	X	X	G	-	-
CHROMIC ACID	X	X	X	X	F	G	C	G	G
CITRIC ACID	E	E	E	E	E	E	E	E	E
COAL OIL	X	X	-	X	X	X	X	E	E
COAL TAR	X	X	G	E	X	X	X	E	E
COAL TAR NAPHTHTHA	X	X	-	-	X	X	-	E	E
COCONUT OIL	X	X	G	E	G	X	C	E	-
COKE OVEN GAS	X	X	X	X	X	X	X	E	-
COPPER CHLORIDE	F	E	C	C	E	E	E	E	E
COPPER CYANIDE	E	E	E	E	E	E	E	E	-
COPPER HYDROXIDE	F	G	-	-	E	G	-	E	E
COPPER SULFATE	F	E	E	E	E	E	E	E	E
CORN OIL	X	X	C	E	E	X	C	E	-
COTTONSEED OIL	X	X	C	C	C	X	C	C	G
CRUDE OIL	X	X	X	G	X	X	X	E	E
CUMENE	X	X	X	X	X	X	X	E	E
CUPRIC HYDROXIDE	-	-	-	-	-	-	-	-	-
CUPRIC SULFATE	F	E	-	-	E	E	-	E	E
CYCLOHEXANE	X	X	X	G	X	X	X	G	E
CYCLOHEXANOL	X	X	G	C	X	X	X	E	E
CYCLOPENTANE	X	X	-	-	X	X	-	E	E
CYCLOPENTANOL	X	X	-	-	X	X	-	E	E

CHEMICAL RESISTANCE CHART

CHEMISCHE BESTÄNDIGKEITSLISTE

TABELLA RESISTENZA CHIMICA

TABLEAU DE REZISTANCE CHIMIQUE



E	EXCELLENT
G	GOOD
F	FAIR
C	ACCEPTABLE
X	UNSATISFACTORY
-	NO DATA



E	SEHR GUT
G	GUT
F	MITTEL
C	AKZEPTABEL
X	NICHT BESTÄNDIG
-	KEIN WERT



E	PERFETTO
G	BUONO
F	MEDIA
C	ACCETTABILE
X	CATTIVO
-	SENZA DATA



E	EXCELLENT
G	BONNE
F	JUSTE
C	ACCEPTABLE
X	NE CONVIENTPAS
-	AUCUNE DONNEE

	NR	SBR CBR	CR	NBR	IR	CSM	EPDM EPM	XLPE	UHMWPE
DDT IN KEROSENE	X	X	F	E	X	X	X	E	E
DETERGENT, WATER SOLUTION	G	G	G	E	E	G	E	-	-
DEVELOPING FLUID (PHOTO)	E	G	E	E	G	E	G	-	-
DI-SO BUTYLENE	X	X	X	G	X	X	X	E	-
DIAMMONIUM PHOSPHATE	-	-	-	-	-	-	-	-	-
DIAMYL NAPHTHALENE	X	X	-	-	E	X	-	E	-
DIBENZYL ETHER	X	X	X	X	E	X	X	E	E
DIBROMOBENZENE	X	X	-	-	X	X	-	E	G
DIBROMOMETHANE	-	-	-	-	-	-	-	-	-
DIBUTYL ETHER	X	X	X	X	G	X	C	E	E
DIBUTYLAMINE	X	X	X	X	X	X	X	-	E
DICHLOROBENZENE	X	X	X	X	X	X	X	G	G
DICHLORODIFLUOROMETHANE	X	X	-	-	X	X	-	-	E
DICHLOROETHANE	X	X	-	-	X	X	-	E	E
DICHLOROETHYL ETHER	X	X	-	-	X	X	-	E	E
DICHLOROHEXANE	X	X	-	-	X	X	-	E	E
DICHLOROMETHANE	X	X	-	-	X	X	-	E	E
DICHLOROPROPANE	X	X	-	-	X	X	-	E	E
DICHLOROTOLUENE	-	-	-	-	-	-	-	-	-
DIESEL OIL	X	X	C	E	X	C	X	C	E
DIETHANOL AMINE	G	G	-	-	E	F	-	-	E
DIETHYL ETHER	X	X	C	X	X	X	X	E	-
DIETHYL KETONE	F	X	-	-	G	X	-	E	E
DIETHYLPHTHALATE	X	X	X	-	E	X	G	E	E
DIETHYL SULFATE	-	-	-	-	-	-	-	-	E
DIETHYLAMINE	G	G	C	C	E	C	G	C	E
DIMETHYL KETONE	-	-	-	-	-	-	-	-	E
DIMETHYL SULFATE	-	-	-	-	-	-	-	-	E
DIMETHYLAMINE	-	-	-	-	-	-	-	E	E
DIMETHYLBENZENE	-	-	-	-	-	-	-	-	E
DISODIUM PHOSPHATE	E	E	-	-	E	E	-	E	E
DIVINYL BENZENE	X	X	-	-	X	X	-	E	E
DRY CLEANING FLUIDS	-	X	X	C	X	X	X	-	-
ETHANOIC ACID	-	-	-	-	-	-	-	-	-
ETHANOL (GRAIN ALCOHOL)	E	E	E	C	E	E	E	E	E
ETHANOLAMINE	G	G	G	G	E	C	E	C	E
ETHERS	X	X	X	X	X	X	C	-	-
ETHYL ACETATE	X	X	X	X	G	X	C	E	E
ETHYL ALCOHOL	E	E	E	C	E	E	E	E	E

	NR	SBR CBR	CR	NBR	IR	CSM	EPDM EPM	XLPE	UHMWPE
ETHYL ALDEHYDE	F	-	-	-	E	-	-	E	E
ETHYL BENZENE	X	X	X	X	X	X	X	E	E
ETHYL CHLORIDE	X	X	X	X	F	X	X	G	G
ETHYL ETHER	X	X	X	C	C	X	X	E	E
ETHYL PHTHALATE	-	-	-	-	-	-	-	-	E
ETHYL SILICATE	F	F	E	E	E	G	E	E	E
ETHYLAMINE	F	F	-	-	G	F	-	-	E
ETHYLENE DIAMINE	G	G	E	E	E	F	E	E	E
ETHYLENE DIBROMIDE	X	X	X	X	X	X	C	G	F
ETHYLENE DICHLORIDE	X	X	X	X	X	X	X	G	G
FATTY ACIDS	X	X	C	C	X	X	X	E	G
FERRIC CHLORIDE	E	E	G	E	E	E	E	E	E
FERRIC NITRATE	E	E	E	E	E	E	E	E	-
FERRIC SULFATE	E	E	E	E	E	E	E	E	E
FORMALDEHYDE	G	C	C	X	E	C	G	E	E
FORMIC ACID	G	G	C	X	E	F	E	C	E
FREON SO 2	-	-	E	-	-	-	E	-	-
FREON 113	C	G	E	E	-	E	C	-	-
FREON 12	X	X	G	G	X	X	X	C	E
FREON 22	X	X	X	X	F	X	-	C	E
FUEL OIL	X	X	G	E	X	E	X	C	E
GAS, COAL	-	-	-	-	-	-	-	-	-
GAS, HIGH OCTANE	-	-	X	G	-	-	X	-	-
GLUCOSE	E	E	G	G	E	E	G	E	G
GLYCERINE	E	E	E	E	E	E	E	C	E
GREASE	X	X	X	E	X	X	X	G	E
HELIUM	E	E	E	E	E	E	E	-	-
HEXANE	X	X	C	C	X	X	X	G	G
HEXANOL	E	E	-	-	E	E	-	E	E
HEXENE	X	X	G	G	X	G	X	E	G
HYDRAULIC & MOTOR OIL	X	X	C	E	X	G	X	E	-
HYDROBROMIC ACID	E	X	X	X	E	E	E	C	G
HYDROCHLORIC ACID	E	X	X	X	F	X	X	E	E
HYDROCIANIC ACID	X	-	E	C	E	C	C	-	-
HYDROFLUORIC ACID	X	X	X	X	E	E	X	C	E
HYDROGEN CHLORIDE ANHYDROUS	-	-	-	-	-	-	-	-	-
HYDROGEN DIOXIDE (10 %)	X	X	-	-	F	-	-	-	G
HYDROGEN GAS	G	G	E	E	E	G	E	E	E
HYDROGEN PEROXIDE OVER 10 %	X	X	X	X	X	X	X	C	F

CHEMICAL RESISTANCE CHART

CHEMISCHE BESTÄNDIGKEITSLISTE

TABELLA RESISTENZA CHIMICA

TABLEAU DE REZISTANCE CHIMIQUE



E	EXCELLENT
G	GOOD
F	FAIR
C	ACCEPTABLE
X	UNSATISFACTORY
-	NO DATA



E	SEHR GUT
G	GUT
F	MITTEL
C	AKZEPTABEL
X	NICHT BESTÄNDIG
-	KEIN WERT



E	PERFETTO
G	BUONO
F	MEDIA
C	ACCETTABILE
X	CATTIVO
-	SENZA DATA



E	EXCELLENT
G	BONNE
F	JUSTE
C	ACCEPTABLE
X	NE CONVIENTPAS
-	AUCUNE DONNEE

	NR	SBR CBR	CR	NBR	IIR	CSM	EPDM EPM	XLPE	UHMWPE
HYDROGEN PEROXIDE 10 %	X	X	X	X	F	F	F	C	G
IODINE	C	C	C	C	C	E	C	C	E
JET FUELS	X	X	X	E	X	X	X	E	E
KEROSENE	X	X	X	E	X	C	X	E	E
KETONES	X	X	X	C	E	X	E	-	-
LACQUER SOLVENTS	X	X	X	X	X	X	X	G	-
LACTIC ACID - COLD	G	G	G	X	E	G	X	C	-
LACTIC ACID - HOT	X	X	X	X	-	C	X	-	-
LAVENDER OIL	X	X	X	G	X	X	X	G	-
LEAD ACETATE	E	X	X	G	G	X	E	E	E
LEAD NITRATE	E	E	E	E	E	X	E	-	-
LEAD SULFATE	-	-	-	-	-	E	E	E	E
LIME	-	-	-	X	-	-	G	-	-
LINOLEIC ACID	X	X	X	G	X	X	X	-	-
LINSEED OIL	X	X	X	E	C	C	X	C	E
LIQUID PETROLEUM GAS (LPG)	X	X	X	E	X	X	X	E	X
LUBRICATING OILS	X	X	X	G	X	F	X	E	E
LYE SOLUTIONS	G	G	G	G	E	E	E	-	G
MEK	X	X	X	X	G	X	E	E	G
MAGNESIUM CHLORIDE	E	E	E	E	E	E	E	E	E
MAGNESIUM HYDROXIDE	E	G	G	G	E	G	E	E	E
MAGNESIUM SULFATE & SULPHITE	E	E	E	E	E	E	E	E	E
MALEIC ACID	X	X	X	X	X	X	X	G	E
MALIC ACID	C	C	C	C	X	G	X	C	G
MERCURY	E	E	E	E	E	E	E	E	-
MERCURY VAPORS	E	E	E	E	E	E	E	-	-
METHANOIC ACID	-	-	-	-	-	-	-	-	-
METHANOL (METHYL ALCOHOL)	E	E	E	E	E	E	E	-	E
METHYL ACETATE	X	X	X	X	G	X	E	E	E
METHYL CHLORIDE	X	X	X	X	C	X	X	G	E
METHYL CYANIDE	-	-	-	-	-	-	-	-	-
METHYL METHACRYLATE	X	X	X	X	X	X	C	G	G
MINERAL OIL	X	X	X	E	X	F	X	E	-
MINERAL SPIRITS	X	X	X	E	X	X	X	E	E
MOLTEN SULFUR	X	X	X	-	G	F	-	X	-
MONOCHLOROBENZENE	X	X	X	X	X	X	X	G	G
MORPHOLINE	-	-	-	X	-	-	X	-	-
MOTOR OIL, 40 W	-	-	-	-	-	-	-	-	-
MURIATIC ACID	E	X	X	X	F	X	F	E	E
N-OCTANE	X	X	X	G	X	X	X	G	-

	NR	SBR CBR	CR	NBR	IIR	CSM	EPDM EPM	XLPE	UHMWPE
NAPHTHA	X	X	X	C	X	-	X	E	E
NAPHTHALENE	X	X	X	X	F	X	X	E	E
NAPHTHENIC ACIDS	X	X	X	G	-	X	X	-	-
NATURAL GAS	X	X	E	E	X	F	X	C	-
NEON GAS	E	E	E	E	E	E	E	-	-
NICKEL CHLORIDE	E	E	G	E	E	E	E	E	E
NICKEL NITRATE	E	E	E	-	E	E	E	E	E
NICKEL SULFATE	E	E	E	E	E	E	E	E	E
NITRIC ACID, CONC (16N)	X	X	X	X	C	G	X	G	-
NITRIC ACID, RED FUMING	X	X	X	X	G	X	X	X	X
NITRIC ACID, 10 %	X	X	X	X	G	X	C	C	E
NITRIC ACID, 13 N	-	-	-	-	-	-	-	-	-
NITRIC ACID, 13 N + 5 %	-	-	-	-	-	-	-	-	-
NITRIC ACID, 20 %	X	X	X	X	G	X	G	E	E
NITRIC ACID, 30 %	X	X	X	X	F	X	C	E	G
NITRIC ACID, 30 % - 70 %	X	X	X	X	F	F	F	G	F
NITROBENZENE	X	X	X	X	F	X	X	E	E
NITROETHANE	G	G	C	X	G	G	G	E	-
NITROGEN	E	E	E	E	E	E	E	E	E
NITROMETHANE	G	C	C	X	G	C	G	E	-
NITROUS OXIDE GAS	-	-	-	-	-	-	-	-	E
OIL-PETROLEUM	X	X	G	E	X	F	X	E	G
OLEIC ACID	X	X	X	C	G	X	X	E	E
OLEUM (FUMING SULFURIC ACID)	X	X	X	C	X	X	X	X	X
OLIVE OIL	X	X	E	E	E	F	E	C	-
ORTHO-DICHLOROBENZENE	X	X	X	X	X	X	X	G	E
ORTHOXYLENE	X	X	-	-	X	X	-	E	G
OXALIC ACID	X	X	X	X	E	X	E	G	E
OZONE	X	X	C	X	G	G	E	E	E
PAINT THINNER	X	X	X	X	X	X	X	-	-
PALMITIC ACID	X	X	C	E	E	C	C	C	E
PAPERMAKERS ALUM	E	E	E	E	E	E	E	E	E
PARA-DICHLOROBENZENE	X	X	X	X	X	X	X	G	-
PARAFFIN WAX	X	X	G	E	X	X	X	X	E
PARALDEHYDE	F	-	-	-	E	-	-	E	E
PARAXYLENE	X	X	-	-	X	X	-	E	E
PENTACHLOROETHANE	X	X	-	-	X	X	-	E	E
PENTANE	X	X	G	E	X	F	X	G	G
PERCHLORIC ACID-2 N	X	X	C	X	G	G	C	E	-
PHENOL	X	X	X	X	G	G	G	E	E

CHEMICAL RESISTANCE CHART

CHEMISCHE BESTÄNDIGKEITSLISTE

TABELLA RESISTENZA CHIMICA

TABLEAU DE REZISTANCE CHIMIQUE



E	EXCELLENT
G	GOOD
F	FAIR
C	ACCEPTABLE
X	UNSATISFACTORY
-	NO DATA



E	SEHR GUT
G	GUT
F	MITTEL
C	AKZEPTABEL
X	NICHT BESTÄNDIG
-	KEIN WERT



E	PERFETTO
G	BUONO
F	MEDIA
C	ACCETTABILE
X	CATTIVO
-	SENZA DATA



E	EXCELLENT
G	BONNE
F	JUSTE
C	ACCEPTABLE
X	NE CONVIENTPAS
-	AUCUNE DONNEE

	NR	SBR CBR	CR	NBR	IIR	CSM	EPDM EPM	XLPE	UHMWPE
PHOSPHORIC ACID 10 %	E	E	X	X	E	E	X	E	E
PHOSPHORIC ACID 10 % - 85 %	G	G	X	X	G	E	X	E	E
PINE OIL	X	X	X	X	X	X	X	E	E
POTASSIUM BISULFATE	E	E	-	-	E	E	-	E	E
POTASSIUM CARBONATE	E	E	E	-	E	E	E	E	E
POTASSIUM CHLORIDE	E	E	E	E	E	E	E	E	E
POTASSIUM CHROMATE	-	-	-	-	E	F	-	G	G
POTASSIUM CYANIDE	E	E	E	E	E	E	E	E	-
POTASSIUM DICHROMATE	G	G	E	E	E	F	E	G	G
POTASSIUM HYDROXIDE	E	G	C	X	E	G	E	E	G
POTASSIUM PERMANGANATE, 5 %	-	-	-	-	-	-	-	-	-
POTASSIUM SULFATE	E	E	E	E	E	E	E	E	E
PROPANE	X	X	C	E	X	G	X	E	-
PROPYLENE	X	X	X	X	X	X	X	-	-
REFRIGERANT 11	-	-	X	G	-	-	X	-	-
REFRIGERANT 12	-	-	G	E	-	-	X	-	-
REFRIGERANT 22	-	-	G	X	-	-	X	-	-
SAL AMMONIAC	E	E	E	E	E	E	E	-	-
SEA WATER	E	E	G	E	E	E	E	E	E
SEWAGE	F	F	E	E	F	E	F	E	E
SILICONE OIL	E	E	E	E	E	E	E	-	-
SILVER NITRATE	E	E	E	G	E	E	E	E	-
SOAP SOLUTIONS	G	E	G	E	E	E	E	E	E
SODA ASH	E	E	E	E	E	E	E	E	E
SODA LIME	E	G	-	-	E	G	-	E	E
SODIUM ACETATE	X	X	G	G	G	X	E	E	E
SODIUM BICARBONATE	E	E	E	E	E	E	E	-	-
SODIUM BISULFATE	F	F	E	E	F	E	E	E	E
SODIUM BORATE	E	E	E	E	E	E	E	E	-
SODIUM CARBONATE	E	E	E	E	E	E	E	E	E
SODIUM CHLORIDE	E	E	E	E	E	E	E	E	E
SODIUM CYANIDE	E	E	E	E	E	E	E	E	-
SODIUM DICHROMATE	C	C	C	C	E	F	E	G	E
SODIUM HYDROXIDE (CAUSTIC SODA)	E	G	G	X	E	G	E	E	E
SODIUM HYPOCHLORITE	X	X	X	G	G	F	G	G	G
SODIUM NITRATE	E	E	G	G	E	E	E	E	E
SODIUM PEROXIDE	G	G	G	G	E	G	E	E	-
SODIUM PHOSPHATE	E	E	G	E	E	E	E	E	-
SODIUM SULFATE	E	E	E	E	E	E	E	E	E
SOYBEAN OIL	X	X	G	E	E	G	C	E	G
STEAM, BELOW 350 DEG F	X	X	X	X	G	X	E	X	-
STEARIC ACID	X	X	G	G	G	X	G	E	E

	NR	SBR CBR	CR	NBR	IIR	CSM	EPDM EPM	XLPE	UHMWPE
STYRENE	X	X	X	X	X	X	X	G	G
SULFUR	X	X	X	X	F	G	G	-	-
SULFUR CHLORIDE	X	X	C	C	X	G	X	E	-
SULFUR DIOXIDE	C	C	X	X	G	G	G	C	G
SULFURIC ACID 60 % (200F)	-	-	-	-	-	-	-	C	G
SULFURIC ACID, CONC.	X	X	X	X	X	E	X	E	G
SULFURIC ACID, FUMING	X	X	X	X	X	X	X	X	X
SULFURIC ACID, 25 %	X	X	X	X	G	E	E	E	E
SULFURIC ACID, 25 % - 50 %	X	X	X	X	C	G	G	E	E
SULFURIC ACID, 50 % - 96 %	X	X	X	X	X	C	X	G	G
TAR	X	X	G	X	X	X	X	X	X
TAR BITUMINOUS	X	X	C	G	X	X	X	-	-
TARTARIC ACID	C	X	G	E	E	E	G	C	E
TETRACHLORO BENZENE	X	X	-	-	X	X	-	G	G
TETRACHLOROETHANE	X	X	-	-	X	X	-	E	G
TETRACHLOROETHYLENE	X	X	X	X	X	X	X	E	E
TETRACHLOROMETHANE	X	X	-	-	X	X	-	E	E
TIN CHLORIDE	E	E	-	-	E	E	-	E	E
TITANIUM TETRACHLORIDE	X	X	X	G	X	X	X	-	G
TOLUENE	X	X	X	X	E	X	X	G	E
TRICHLOROACETIC ACID	C	G	X	G	G	X	G	E	-
TURPENTINE	X	X	X	X	X	X	X	G	E
UREA	-	-	E	-	E	-	-	E	E
URETHANE FORMULATIONS	-	-	-	E	-	-	-	-	-
URIC ACID	-	-	-	-	-	-	-	-	-
VARNISH	X	X	X	G	-	X	X	-	-
VEGETABLE OILS	X	X	C	E	E	X	C	E	-
VINEGAR	E	F	F	X	E	F	E	X	-
VINEGAR ACID	-	-	-	-	-	-	-	-	-
VINYL ACETATE	X	X	-	-	G	X	-	E	E
VINYL BENZENE	X	X	-	-	X	X	-	G	E
VINYL CHLORIDE	X	X	X	X	X	X	X	E	E
VINYL CYANIDE	-	-	-	-	-	-	-	-	-
VINYL STYRENE	-	-	-	-	-	-	-	-	-
VINYL TOLUENE	X	X	-	-	X	X	-	E	E
WATER	E	E	E	E	E	E	E	E	E
WATER, BOILING	C	C	E	C	C	C	E	C	C
WHISKEY	E	E	E	E	E	E	E	E	E
WINES	E	E	E	E	E	E	E	E	E
ZINC CHLORIDE	E	E	E	E	E	E	E	E	E
ZINC CHROMATE	-	-	-	-	E	F	-	G	E
ZINC SULFATE	G	G	E	E	E	E	E	E	E

Use - Maintenance - Conservation - Shipment & Storage

Hoses have a certain life-time. Users must necessarily choose the hose that suits best to the work to be carried out. In case the work to be carried out brings about risks, users must use a hose of a nature enabling elimination of all possible risks.

Particularly, users must pay ultimate attention to opted hose in case of high operating pressures. Hoses must not be used for any purpose other than those that are met for design specifications. The hose must be used in such a way that there should be no sharp bending.

Hoses must not be used under such pressures higher than operation pressures specified in their design characteristics. During hose use, there must be no sudden pressure increase, however, the pressure must be increased gradually. Hoses must not be kinked, and forced by associated apparatuses and devices during use. When carrying big-size heavy hoses, attention must be paid for proper carriage by using hangers or carriage equipments. Particularly, in A/V heavy duty hoses, proper supporting apparatuses must be used.

During storage, hoses may negatively be affected from ozone, sunlight, oils, solvents, smoke, corrosive liquids, insects, rodents and radioactive materials. Proper storage for hoses depends on diameter and length size, quantity and packaging type of the hose. If hoses are bundled, bundles must not be stowed vertically but horizontally. Generally, wire braided and heavy hoses should be placed at the bottom while light hoses should be superposed.

If possible, hoses must be stored in their original packaging. If hoses are stored in cases, wood or cardboard cases should be preferred. Ideal storage temperature is 10-20 °C. Avoid storing at temperatures higher than 38 °C.

Unless otherwise specified in their design, hoses harden under 0 °C. Therefore, they must be restored to operating temperature range, if possible, before use. Hoses must be kept away from heat sources (radiator, stove, etc.) and hot surfaces. They must not be stored at such environments with high and low humidity conditions. Hoses are negatively affected from conditions of high ozone concentration. They must be protected from direct or reflecting sunlight. Lights emitted by florescent and mercury lamps have detrimental effects on unpackaged hoses. Storage area should be relatively cool and dark, and free from mold and humidity. When using hoses, FIFO (First In, First Out) principle should be preferred for moving out of storage area. If foregoing instructions are observed, the life of hose will be prolonged.

Sales Terms & Conditions

1.Scope: These terms and conditions apply to your purchase from Polimer Kaucuk (referred to below as Seller). You (referred to below as Buyer or Buyers) acknowledge that Buyer is fully aware of the contents of these terms and conditions and, on placing any purchase order for any products; Buyer agree to be bound by and accept these terms and conditions. Buyers acknowledgement receipt and acceptance of products shall constitute of Buyer's acceptance of the terms and conditions stated herein.

2.Ordering Process: Orders received by the Seller are accepted only upon written confirmation. Seller possesses the exclusive right to accept or refuse all orders. Until written confirmation from the Seller no bid, offer, or quotation will be binding upon the Seller.

3.Prices: All prices are subject to change and the Seller shall notify the Buyer before shipment.

4.Delivery: The Seller reserves the right to select shipment method and term. All shipments shall be EXW unless differently agreed in the contract. Claims for damage or loss in transit must be filled by Buyer against to carrier.

Delivery dates are estimates and not guaranteed by Seller. Seller shall not be liable or failure or delay in shipping goods, if such failure or delay is due to an act of God, fire, flood, war, labor difficulties, accident, strikes, lockouts, civil disorders, governmental priorities or embargos, inability or difficulty in obtaining raw materials or supplies at contracted raw material prices or any other reasons which are beyond the control of the seller. In such cases Seller should notify buyer of these causes of this force major. Buyer shall not refuse to accept deliveries so delayed.

Buyer is responsible for collecting products in five business days upon buyer's notice of readiness for shipment. Buyer shall be responsible for all storage and related expenses caused by Buyer's delay collecting the products.

5.The contract modification and cancellation: Buyer may not cancel or modify any order without Seller's prior written consent and accepts responsibility for all the applicable costs incurred by the Seller due to such cancellation or modification. Seller may suspend the contract if the Buyer is considered financially insecure.

6.Tolerances of the order: The seller reserves the right during the production of the order to supply up to $\pm 10\%$ of the confirmed quantities.

7>Returns: Seller must confirm the return of any product before its shipment by Buyer. If the buyer decides the ship without Seller's consent Buyer shall be responsible for all related costs and risks.

8.Payment: Buyer is liable to pay at agreed date and currency and if such payment is not materialized at agreed date, buyer shall be liable for interest charges of 2% above LIBOR on the unpaid balance. If buyer is considered financially insecure, seller reserves the right to request advance payment of unshipped material and all other claims.

9.Warranty: Seller warrants that its products shall be free from defects in material and workmanship under normal use and service for a period of 12 months from date of shipment.

On equipment and materials furnished by Seller but manufactured by others, Buyer shall accept in lieu of any liability or guarantees on the part of Seller, the benefits of guarantees as are obtained by Seller from such manufacturers or vendors. This warranty does not cover any defect arise from normal deterioration, inadequate maintenance, incorrect repair, storage conditions and failure to follow user and operator instructions. Failure by Buyer to object to or reject products or materials delivered hereunder, in writing 30 days from the date of shipment of the products and materials, shall constitute an acceptance and waiver by Buyer of all claims hereunder due to alleged errors, shortages, defective workmanship or material, breach of warranty or otherwise, discoverable upon inspection by Buyer. Seller shall in no event be liable for direct, indirect, incidental or consequential damages.

There are no other warranties either expressed or implied beyond those set forth herein.

Benutzung - Wartung - Sicherung - Transport und Lagerung

Die Schläuche haben eine bestimmte Lebensdauer. Die Benutzer müssen für ihre Arbeitstätigkeit unbedingt den entsprechenden Schlauch auswählen. Falls die Arbeitstätigkeit eventuelle Risiken beinhalten, müssen sie dafür den Schlauch auswählen der diese Risiken beseitigen wird.

Insbesondere bei Betrieben mit Hochdruck müssen die Benutzer bei der Auswahl der Schläuche sehr vorsichtig sein. Die Schläuche dürfen außer den Arbeiten die ihrer Eigenschaft entsprechen nicht anderweitig benutzt werden. Der Schlauch darf nicht in gefalteter Position benutzt werden.

Die Schläuche dürfen nicht bei höheren Druckwerten als die, die in der Konstruktion angegeben sind benutzt werden. Während der Anwendung der Schläuche darf der Druck nicht ruckartig sondern stufenweise erhöht werden. Die Schläuche dürfen während der Benutzung nicht gerissen und auch nicht durch das angebundene Gerät aufgesprengt werden. Die schweren und groß dimensionierten Schläuche sollten, falls die Möglichkeit besteht, mit Aufhänger haken oder einer entsprechenden Transportausrüstung befördert werden. Vor allem die schweren S/D Leistungsschläuche müssen mit den entsprechenden Unterstützungsapparaten transportiert werden.

Die Schläuche müssen während der Lagerung vor Ozon, direktem Sonnenstrahl, Fetten, Solventen, Dunst, korrosiven Flüssigkeiten, Insekten, Nagetieren und radioaktiven Materialien geschützt werden. Die entsprechende Lagerung hängt von dem Durchmesser, der Länge, der Menge und von der Verpackungsart der Schläuche ab. Bei einer Lagerung durch Anhäufung entstehen bei den unteren Abschnitten der Schläuche Fehlbildungen. Wenn die Schläuche im gerollten Zustand sind, sollten die Rollen nicht aufrecht sondern waagrecht gelagert werden. Im Allgemeinen sollten die schweren und mit Draht ausgestatteten Schläuche in den unteren und die leichten in den oberen Reihen gelagert werden.

Wenn es möglich ist sollten die Schläuche in ihren originalen Verpackungen gelagert werden. Wenn sie in Kisten gelagert werden, sollte man dafür sorgen dass die Kisten aus Holz oder aus Pappe sind. Die optimale Lagerungstemperatur ist 10-20 °C. Die Temperaturen, die sich bei über 38 °C befinden, sind für eine Lagerung ungeeignet.

Wenn bei der Konstruktion nicht anders aufgeführt ist, verhärten sich die Schläuche bei einer Temperatur von 0 °C. Aus diesem Grund sollten die kalt gelagerten Schläuche vor dem Betrieb so lange bereitgestellt werden bis sie die gleiche Raumtemperatur erreicht haben. Die Schläuche sollten von Heizkörpern (elektrische Heizgeräte, Ofen u. ä.) und heißen Flächen ferngehalten werden. Auch eine Umgebung mit zu niedriger oder zu hoher Feuchtigkeit ist für eine Lagerung ungeeignet. Bei hohen Ozonkonzentrationen werden die Schläuche negativ beeinflusst. Vor direktem oder gespiegeltem Sonnenstrahl sollten die Schläuche bewahrt werden. Bei unverpackten Schläuchen wirkt sich das Licht aus Leuchtstoffröhren oder Quecksilberampullen schädigend aus. Die Lagerhalle sollte kühl und dunkel sein, Schimmel und Feuchtigkeit sollten vorher beseitigt werden. Bei der Anwendung der Schläuche aus der Lagerhalle, sollten man sich die Fifo-Methode (die zuerst gelagerten sollten zuerst gebraucht werden) zum Prinzip machen.

Wenn man sich den oben aufgeführten Bestimmungen fügt, wird die Lebensdauer der Schläuche um so mehr verlängert.

Allgemeine Geschäftsbedingungen

1. Umfang: Diese Bestimmungen und Bedingungen werden durch die Fabrik Polimer Kauçuk (im Folgenden als Lieferant benannt) bei den Waren die Sie kaufen zugrunde gelegt. Sie (im Folgenden als Kunde benannt) bzw. der/die Kunde werden bestätigen, dass sie von dem Inhalt dieser Bestimmungen, Bedingungen und von ihrer Bestellung Kenntnis haben; Der/die Kunde wird bewilligen, sich diesen Bestimmungen und Bedingungen zu fügen. Der/die Kunde werden mit der Bestätigung des Empfanges und Kauf der Ware automatisch die unten aufgeführten Bestimmungen und Bedingungen angenommen haben.

2. Bestellungsfrist: Die durch den Lieferant angenommenen Bestellungen werden nur nach einer schriftlichen Bestätigung als gültig erklärt. Der Lieferant hat die alleinige Berechtigung die Bestellungen anzunehmen oder abzulehnen. Bis zur schriftlichen Bestätigung des Lieferanten sind jegliche Angebote oder Preise für den Lieferant unverbindlich.

3. Preise: Sämtliche Preise sind veränderungsfähig und werden durch den Lieferant vor der Lieferung an den Kunde mitgeteilt.

4. Lieferung: Der Lieferant hat die Berechtigung, die Lieferungsart und die Lieferungsfrist selbst zu bestimmen. So lange es im Vertrag nicht anders geregelt wird, werden alle Lieferungen ab Fabrik getätigt. Alle Behauptungen in Bezug auf Schäden und sonstige Verluste die beim Transport entstehen sollten, werden durch den Kunden gegen den Frachtführer dokumentiert.

Das Lieferungsdatum ist nur mutmaßlich und wird durch den Kunde nicht garantiert. Für jegliche Fehlleistungen oder Verspätungen die durch Naturkatastrophen, Feuer, Überflutungen, Krieg, Betriebsschwierigkeiten, Streiks, Aussperrungen, soziale Aufstände, Verwaltungsdringlichkeiten oder Liefersperrungen, Ausfälle der Rohstoffe und Materialien, die wegen Änderung der vorbestimmten Rohstoffpreise entstehen oder bei Situationen die nicht unter der Verantwortung des Lieferanten liegen, haftet der Lieferant nicht. Bei solchen Fällen hat der Lieferant die Begründung und den Stand der höheren Gewalt dem Kunden mitzuteilen. Der Kunde kann in solchen Fällen die Annahme der verspäteten Lieferung nicht verweigern. Der Kunde wird nach der Mitteilung der bereitgestellten Ware, diese innerhalb in fünf Werktagen abholen. Bei verspäteter Abholung wird der Kunde die dadurch entstandenen Aufbewahrungskosten und bezügliche Kosten selbst tragen.

5. Die Abänderung und die Kündigung des Vertrages: Der Kunde darf ohne die schriftliche Genehmigung des Lieferanten die Bestellungen nicht absagen oder ändern. Andernfalls ist er verpflichtet, alle Kosten die durch das Absagen oder Änderung beim Lieferant entstehen werden, zu ersetzen. Wenn der Kunde nicht zahlungsfähig erscheint, kann der Lieferant den Vertrag stornieren.

6. Toleranzen bei den Bestellungen: Der Lieferant hat das Recht bis zu $\pm 10\%$ vom genehmigten Betrag für die Dauer der Herstellung von der Bestellung vorzubehalten.

7. Rückerstattung: Vor der Lieferung der zu erstattenden Ware durch den Kunde, muss der Lieferant die Rückerstattung genehmigen. Falls der Kunde ohne die Genehmigung des Lieferanten die Ware zurückliefert, haftet er für alle Kosten und Risiken.

8. Zahlungsbedingung: Der Kunde ist verpflichtet die Bezahlung am festgelegten Datum und in der entsprechenden Währung durchzuführen. Falls die Bezahlung nicht am festgelegten Datum durchgeführt wird, ist der Kunde verpflichtet den nicht bezahlten Betrag, nach den LIBOR Zinsen in Höhe von 2% zu bezahlen. Wenn der Kunde nicht Zahlungsfähig erscheint, hat der Lieferant das Recht die Anzahlung der Materialien und alle weiteren Forderungen, der noch nicht gelieferten Ware vorzubehalten.

9. Garantie: Der Lieferant garantiert ab dem Lieferungsdatum der Ware für 12 Monate lang, dass bei ordnungsmäßiger Benutzung die Ware frei von Material- und Handwerksfehler sein wird.

In Bezug auf die Ausrüstung und Materialien die durch andere hergestellt und durch den Lieferant beschaffen werden, hat der Kunde anstatt die Pflichten und Garantien des Lieferanten, die Garantien und Nutzen von diesen Herstellern und Lieferanten anzunehmen. Diese Garantien beinhalten nicht die Schäden die bei normalen Störungen, ungenügender Wartung, fehlerhaften Reparaturen, Aufbewahrungsbedingungen, fehlerhafter Anwendung und bei Nichteinhaltung der Betriebsvorschriften entstehen. Wenn der Kunde ab dem Lieferdatum der Waren und Materialien, die mit diesem vorliegenden Beleg geliefert werden, nicht innerhalb von 30 Tagen schriftlich widersprechen sollte oder nicht zurückerstatten sollte, wird angenommen, dass er auf alle Forderungen bei Schäden, Defekten, fehlerhaftes Handwerk oder Materialien, Garantiefähigkeit und auch von den Forderungen bei Fehlern, die durch den Kunde festgestellt werden, verzichtet. Gleichzeitig wird auch angenommen, dass der Kunde von allen Behauptungen, die durch diesen Beleg entstehen verzichtet wird und dass er die Waren oder die Materialien bewilligt hat. Der Lieferant ist auf keiner Weise direkt oder indirekt von den Schäden verantwortlich, die durch betriebsfremde Gründe oder durch Risiken entstehen.

Außer den Garantien, die auf diesem Beleg vorgesehen sind, befinden sich keine weiteren direkten noch indirekten Garantien.

Uso - Manutenzione - Protezione - Trasporto e Magazzinaggio

I tubi hanno una durata limitata. Gli utenti devono, assolutamente, scegliere il tubo con le caratteristiche adatte all'impiego. Nel caso di lavorazioni a rischio, è necessario optare per dei tubi che eliminino tali rischi.

Gli utenti devono prestare particolare attenzione alla scelta dei tubi da impiegare nelle lavorazioni ad elevate pressioni.

I tubi non devono essere impiegati per scopi diversi da quelli per cui sono stati progettati.

I tubi devono essere impiegati in modo da evitare che facciano delle pieghe acute.

I tubi non devono essere impiegati a pressioni superiori di quelle indicate. In fase di utilizzo, i tubi non devono subire aumenti di pressione improvvisi ma aumenti gradualmente. Durante la lavorazione i tubi non devono essere piegati e danneggiati dagli apparecchi od attrezzature alle quali sono collegati. I tubi di dimensioni grandi devono essere trasportati con attrezzature idonee. In particolar modo, per i tubi di aspirazione e mandata per impieghi gravosi, devono essere usati supporti speciali idonei.

I raggi di sole, ozono, solventi, fumi, liquidi corrosivi, insetti, roditori e materiali radioattivi potrebbero alterare le caratteristiche dei tubi immagazzinati. Il sistema ideale di stoccaggio dei tubi dipende dalla dimensione, dalla quantità e dall'imballo.

Nel caso di tubi sfusi, vanno posizionati orizzontalmente e non verticalmente. In linea di massima, i tubi contenenti fili metallici e quelli pesanti devono essere posti ai livelli inferiori ed i tubi leggeri ai livelli superiori, in quanto quelli dei livelli bassi potrebbero subire delle deformazioni geometriche.

Entro il limite del possibile, i tubi devono essere immagazzinati con le loro confezioni originali. Nel caso di stoccaggio in casse, sarebbero indicate le casse in legno o in cartone. La temperatura ideale di stoccaggio è 10-20 °C. Evitare di immagazzinare i tubi in ambienti con temperatura superiore ai 38 °C.

Se non indicato diversamente nella progettazione, i tubi s'irrigidiscono al di sotto di 0 °C. Pertanto possibilmente, devono essere riportati corretta temperatura prima dell'utilizzo. I tubi devono essere tenuti lontani dai fonti di calore e superfici calde (termosifoni, stufe, etc...). Non devono essere stoccati negli ambienti troppo secchi o troppo umidi. I tubi subiscono alterazioni negative negli ambienti ad alta concentrazione d'ozono. Devono essere protetti dalla luce diretta, dai raggi di sole e dai loro riflessi. Le luci delle lampade fluorescenti ed a mercurio sono dannose per i tubi privi di confezione. L'ambiente di stoccaggio deve essere sufficientemente fresco ed oscurato e deve essere privo di umidità. Nella movimentazione dei tubi occorre adottare il sistema FIFO (quelli arrivati prima vengono spediti prima). Rispettando quanto riportato sopra, la durata dei tubi sarebbe aumentata notevolmente.

Termini e Condizioni Di Vendita

1. Scopo : Queste regole e condizioni vengono applicate per i prodotti acquistati dalla Polimer Kauçuk (da ora in avanti "Venditore"). Voi (da ora in avanti "Acquirente/i) confermate che siete al corrente dei contenuti e che conoscete termini e condizioni di acquisto dei prodotti. L'Acquirente accetta tali termini e condizioni e s'impegna a rispettarle. La conferma di ricevimento e di accettazione da parte dell'Acquirente indica che le condizioni e le regole sotto descritte sono state accettate.

2. Processo dell'ordine : Gli ordini ricevuti da parte del Venditore sono accettati esclusivamente su conferma scritta. Il Venditore si riserva la facoltà di accettare o di rigettare parte o interamente un ordine. Senza la conferma scritta del Venditore, nessun ordine, offerta o proposta avranno valore d'impegno per il Venditore.

3. Prezzi : Tutti i prezzi sono soggetti a variazioni ed il Venditore deve comunicarle all'Acquirente prima della spedizione.

4. Consegne : Il venditore si riserva la facoltà di scegliere la modalità della spedizione ed i relativi termini. Se non concordato diversamente, tutte le spedizioni s'intendono franco fabbrica. Reclami per danni o perdite subite durante il trasporto vanno indirizzate direttamente al trasportatore.

I Termini di consegna sono approssimativi e non possono essere garantiti da parte del Venditore. Il Venditore non può essere ritenuto responsabile per dei ritardi o mancate spedizioni se le cause sono collegabili a dei fattori non dipendenti dal Venditore, come mancata fornitura di materia prima alle condizioni economiche pattuite, embarghi, priorità amministrative, calamità naturali, incendio, allagamenti, guerre, difficoltà statali, scioperi, serrate, disordini sociali. In questi casi, il Venditore deve dare avviso delle condizioni di forza Maggiore. L'Acquirente non può rifiutarsi di accettare le consegne ritardate per tali motivi.

L'Acquirente é tenuto a ritirare gli articoli entro cinque giorni lavorativi dalla data della comunicazione di merce pronta. Per i costi e le spese accessorie dovuti al ritardo di ritiro della merce la responsabilità cade sull'Acquirente.

5. Revoca e modifica del contratto : L'Acquirente non può annullare o modificare un ordine senza il consenso scritto del Venditore ed in caso di annullamento e modifica accetta di affrontare tutti i costi e le spese sostenute dal Venditore. Nel caso che il Venditore ritenga che l'Acquirente non sia un'azienda solida, può sospendere il contratto.

6. Tolleranze d'ordine : Durante la fase produttiva il Venditore si riserva la facoltà di effettuare la fornitura con una tolleranza del $\pm 10\%$ delle quantità confermate.

7. Merce resa : Il Venditore deve confermare la resa della merce da parte dell'Acquirente prima della spedizione di resa. Nel caso che l'Acquirente si decida di effettuare la spedizione di resa senza il consenso del Venditore, s'assume tutti i costi e tutte le responsabilità relativi.

8. Pagamenti : L'Acquirente é tenuto ad effettuare i pagamenti nella data stabilita ed al cambio stabilito ed in caso di mancato pagamento come pattuito sarà tenuto a pagare 2% oltre al LIBOR (quota d'interessi interbancaria a Londra) d'interessi. Nel caso in cui il Venditore ritenga l'Acquirente finanziariamente inaffidabile e rinuncia alla spedizione della merce, l'Acquirente ha il diritto di richiedere quanto anticipato per la merce non spedita e i relativi diritti.

9. Garanzia : Il Venditore garantisce i prodotti contro difetti di materiale e di lavorazione per la durata di 12 mesi nelle corrette condizioni di utilizzo.

Per i materiali ed attrezzature forniti da parte del Venditore ma prodotti da terzi, l'Acquirente non può richiedere garanzie dirette al Venditore ma accetta le garanzie fornite a favore del Venditore da parte dei produttori. La presente garanzia non copre danni dovuti all'usura ordinaria, agli interventi errati, alla mancata manutenzione ed al non rispetto delle regole di uso, di stoccaggio e di lavorazione. Inadempimento da parte dell'Acquirente di opporsi o rifiutare i prodotti o materiali forniti qui di seguito, per iscritto 30 giorni dalla data di spedizione dei prodotti e dei materiali, costituisce l'accettazione e la rinuncia da parte dell'Acquirente di tutte le richieste a causa di presunti errori, carenze, lavorazione difettosi o materiale, violazione della garanzia o altro, individuabile all'atto dell'ispezione da parte dell'Acquirente. Il venditore non può in alcun caso essere ritenuta responsabile per danni diretti, indiretti, incidentali o consequenziali.

Non sussistono altre garanzie dirette o indirette tranne quelle previste con il presente documento.

Utilisation - Entretien - Protection - Livraison et Stockage

Les tuyaux ont une certaine durée de vie. Les utilisateurs doivent obligatoirement choisir le tuyau le plus adapté à l'utilisation à laquelle ils le destinent. Si l'utilisation présente des risques, il est absolument nécessaire que l'utilisateur utilise le tuyau convenable pour éliminer tout risque.

Les utilisateurs doivent être particulièrement prudents pour des tuyaux destinés à une utilisation en haute pression qui ne doivent pas être utilisés au delà des spécifications techniques. En particulier, le tuyau ne doit pas être utilisé en dessous de son rayon minimum de courbure.

Les tuyaux ne doivent pas être soumis à des pressions plus hautes que celles indiquées dans les spécifications techniques. Lors de l'utilisation les coups de béliers doivent être évités, la pression doit augmenter progressivement. Lors de l'utilisation les tuyaux ne doivent pas être pliés et forcés par la machine sur laquelle ils sont montés. La manutention des tuyaux lourds de grand diamètre doit être effectuée avec précautions au moyen d'équipements de levage adaptés. Notamment il faut utiliser des supports convenables pour les tuyaux d'aspiration et de refoulement d'une masse linéaire importante.

Durant le stockage, l'exposition des tuyaux à l'ozone, aux rayons du soleil, aux graisses, aux solvants, à la fumée, aux liquides corrosifs, aux insectes et aux matériaux radioactifs diminuent la durée de vie des tuyaux. Le stockage adéquat des tuyaux dépend du diamètre et de la longueur de ceux-ci. Le stockage horizontal en vrac provoque une déformation au niveau des tuyaux placés en dessous, et donc les tuyaux lourds à renforcement acier doivent être rangés en dessous, et les tuyaux légers en dessus. Dans le cas des tuyaux en bobines, celles-ci doivent être stockées horizontalement et non verticalement.

Si possible il faut stocker les tuyaux dans leur emballage d'origine. S'ils sont conservés dans des caisses celles-ci doivent être en bois ou en carton. La température de stockage idéale est 10-20 °C et celle-ci ne doit pas dépasser 38 °C.

Les tuyaux durcissent à une température inférieure à 0 °C, sauf s'ils ont été prévus pour éviter cela. En conséquence il est préférable, avant utilisation, de les rétablir à leur température de service. Il faut les conserver à l'abri des sources de chaleur et des surfaces chaudes. Il ne faut pas les stocker dans des milieux dont l'humidité peut-être élevée ou basse. Le contact des tuyaux à l'ozone est défavorable à leur durée de vie. De la même manière ils doivent être protégés des sources d'ultra violet qu'elles soient directes ou indirectes. Il est préférable de les maintenir dans leur emballage original. La zone de stockage doit être sombre et dépourvue de l'humidité et de moisissures. La méthode FIFO (faire sortir les marchandises qui sont entrées en premier) doit être choisie en priorité pour la mise en service des tuyaux en provenance de la zone de stockage.

Respecter ces quelques recommandations prolongera la vie des tuyaux souples.

Termes et Conditions de Vente

1. Contenu : Ces conditions et clauses sont applicables aux produits vendus par Polimer Kauçuk (ci-dessous Dénommé Vendeur). Vous (ci-dessous dénommé Acheteur ou Acheteurs) confirmez que vous connaissez totalement le contenu de ces conditions et des clauses et termes de ces conditions générales de vente en délivrant la commande d'achat. L'Acheteur accepte ces conditions et ces clauses et accepte de les respecter. La confirmation d'achat et d'acceptation de ces produits par l'Acheteur signifie que ce dernier a accepté également des clauses et des conditions ci-dessous mentionnés.

2. Le délai de commande: Seul un accusé de réception de commande en provenance du vendeur peut faire foi. Le vendeur réserve le droit d'accepter ou de refuser la commande. Aucune offre, proposition ou offre de prix n'engage le vendeur jusqu'à la confirmation de commande écrite de ce dernier.

3. Prix: Tous les prix sont susceptibles d'être modifiés et le Vendeur communiquera cette modification au l'Acheteur avant d'expédition.

4. Livraison: Le Vendeur se réserve le droit de choisir le mode et le délai d'expédition. Toutes les expéditions sont considérées comme EXW sauf si une disposition contraire est indiquée dans le contrat. Les réserves émises pour dommage ou perte de marchandise doivent être adressées par l'Acheteur au transporteur par lettre recommandée avec accusé de réception.

Les dates du livraison sont estimatives et ne sont pas garanties par le Vendeur dans les cas suivants : embargos, mouvements sociaux, lock-out, gr d'obtenir des matières premières au prix d'achat contractuel. Dans ce cas le Vendeur doit informer l'Acheteur de ces cas de force majeurs. L'Acheteur ne pourra alors refuser les livraisons en retard.

L'Acheteur est tenu d'enlever les produits dans cinq jours à compter de la notification de mise à disposition du Vendeur. Les frais de stockage seront à la charge de l'Acheteur dans le cas où les marchandises ne sont pas enlevées dans le délai convenu.

5. La modification et la résiliation du contrat de vente: L'Acheteur n'a pas le droit d'annuler ou de modifier la commande sans l'autorisation écrite du vendeur et s'engage à indemniser le vendeur des frais découlant de cette modification ou cette résiliation. En cas de défaillance financière de l'Acheteur, le vendeur pourra suspendre le contrat.

6. Tolérances relatives du Contrat : Le Vendeur réserve le droit de fournir le +10 % des quantités confirmées.

7. Retour des marchandises : Aucune marchandise ne peut être retournée au vendeur sans son acceptation expresse. Si l'Acheteur renvoie au vendeur la marchandise sans son autorisation, il sera reconnu responsable des risques et des charges découlant de son acte.

8. Paiement : L'Acheteur, s'engage à effectuer le paiement à la date et au taux de change prévu. Dans le cas où le paiement n'est pas effectué à la date convenue l'Acheteur versera des intérêts moratoires au taux LIBOR (taux d'intérêt entre des Banques Londoniennes) plus 2 % sur le solde non acquitté. Le vendeur se réserve le droit de demander à l'Acheteur le paiement à l'avance de la marchandise non expédiée.

9. Garantie : Les produits sont garantis contre les vices de fabrication dans les conditions normales d'utilisation et de service pour une durée de 12 mois à compter de la date d'expédition.

Pour les matériaux ou les équipements fournis par le Vendeur mais fabriqués par d'autres, le Vendeur ne fournira pas de garantie à l'Acheteur et ce dernier profitera de la garantie donnée au Vendeur par les fabricants ou par les fournisseurs. Cette garantie ne couvre pas les détériorations normales, l'entretien insuffisant, les réparations et conditions de conservation inadéquates et les défauts relevant du non respect des instructions d'utilisation et de fonctionnement. Dans le cas où aucune réclamation ou aucun refus est communiqué par écrit au Vendeur par l'Acheteur dans 30 jours à compter de l'expédition des matériaux et des produits, ceux-ci sont considérés comme acceptés par l'Acheteur qui renonce à toute prétention découlant des vices de fabrication, ou des matériaux. Le vendeur ne sera pas tenu responsable des dommages directs et indirects provenant du défaut de fabrication. Les matériaux et les produits ne comportent pas d'autres garanties directes ou indirectes que celles mentionnées dans ce document.



HEADQUARTERS



**POLİMER KAUÇUK
SANAYİ VE PAZ. AŞ.**

Huzur Mahallesi İmam Çeşme Yolu Caddesi Candan Sokak No:3
34396 Ayazağa/Şişli/İSTANBUL - TÜRKİYE
Tel: +90 212 331 45 00 Fax: +90 212 331 46 97
www.sel.com.tr



ÇERKEZKÖY FACTORY